

SERRUBEC INC.

Security Hardware Solution Specialists

INDUSTRIAL • COMMERCIAL • RESIDENTIAL

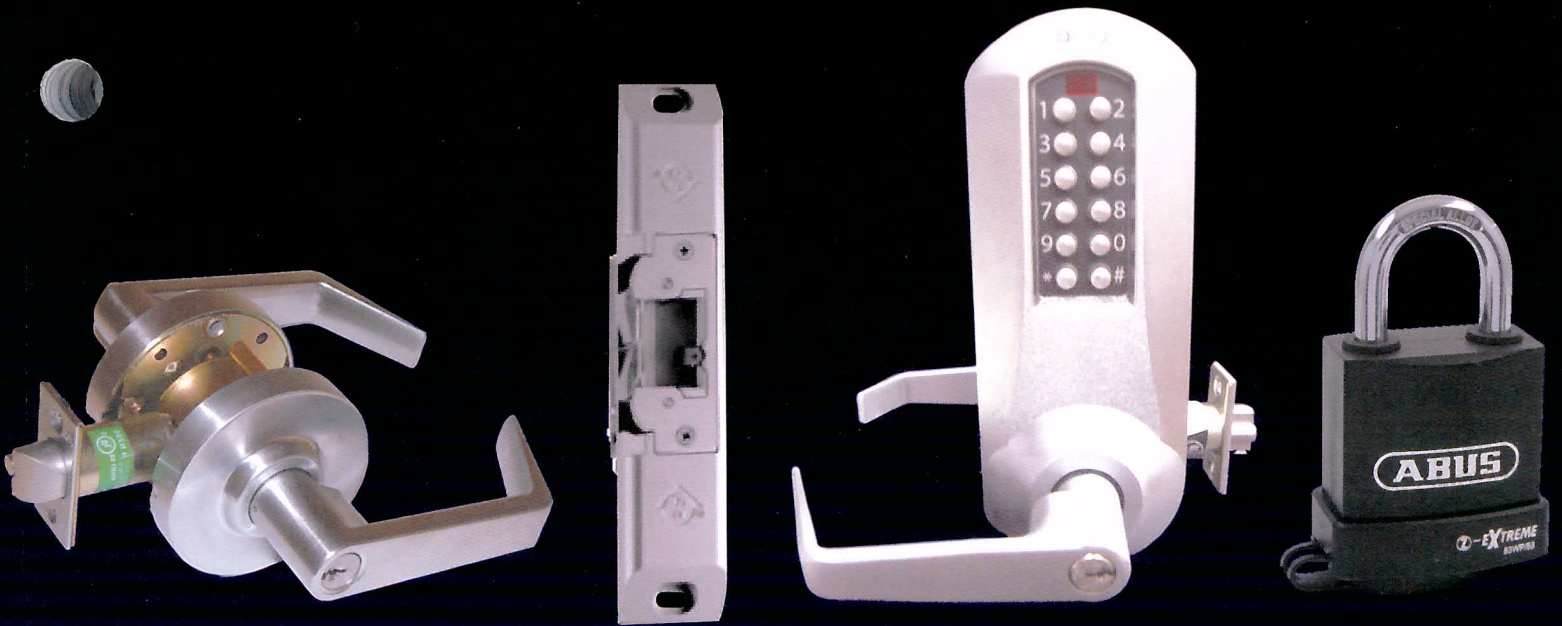

**SINGLE SOURCE
SUPPLIER**

Proven Source. Proven Solutions.

Product Catalogue

TABLE OF CONTENTS

COMPANY	PAGE	COMPANY	PAGE
ABLOY	1	KEYSCAN	131
ABUS	4	KWIKSET	135
ACSI	20	LAB	136
ADAMS RITE	21	LCN	140
ALARM LOCK	28	LOCKSAVER	145
AMERICAN LOCK	31	LUCKYLINE	146
AMSEC	32	MAG	161
ASSA	36	MASTER LOCK	166
BONAFIDE	39	MAJOR	176
CAMDEN CONTROLS	40	McDOWELL-CRAIG	177
CCL	47	MIWA	178
CDH	48	MONARCH	179
CHARLEY-BAR	49	NATIONAL	180
CHICAGO LOCK	50	NORTON	185
CMC	51	OLYMPUS	186
CORBIN	52	PUNDRA	187
DETEX	55	RAYOVAC	189
DOM	57	RIOPEL	190
DON-JO	58	RUTHERFORD CONTROLS	191
DOOR GUARDIAN	62	SARGENT	196
DORMA	63	SARGENT & GREENLEAF	202
DOR-O-MATIC	64	SCHLAGE	203
EDWARDS	65	SECURITRON	217
EMTEK	66	STANLEY	219
ESP	67	STARRETT	220
FOLGER ADAMS	68	STRATTEC	221
FORT LOCK	69	SUPRA	223
GLYNN-JOHNSON	70	THOMAS	225
HAGER HINGE	71	TIMBERLINE	226
HALSCO	72	TUFOIL	229
HES	88	VON DUPRIN	230
HOWARD KEYS	94	WD-40	234
HPC	98	WEISER	235
IDEAL	108	WEST COAST	238
ITL	109	YALE	239
IVES	110	LASER ENGRAVING	
KABA-ILCO	111	GUIDES	
KEEDEX	128	DISPLAYS / MOUNTS	
KEVRON	130	PRODUCT INDEXING	

The unique ABLOY® rotating detainer disc cylinder provides superior master-keying possibilities with vast number of combinations. It offers optimum resistance against physical attack and picking.

DEADBOLTS



- UL listed products
UL Burglary
UL 20 min fire rating
- Case hardened steel cylinder housing
- Rotating collar
- Optional key lockable thumbturn
- 6 mm steel retaining screws
- High security bolt
hardened steel with 2" length
1" (25,4 mm) throw
- Reinforced steel strike box
- Protective bolt shield

SINGLE CYLINDER DEADBOLT

AP-ME107N-77CC-26D-SA
AP-ME-107N-77CC-C3-SA-LT
AP-ME153N-C26D
AP-ME153N-C26D-FF
AP-ME153N-C3
AP-ME153NKA-PR-C26D
AP-ME153NKA-PR-C3
AP-ME153NSA-C26D

DOUBLE CYLINDER DEADBOLT

AP-ME151NSA-C5
AP-ME151N-C26D
AP-ME151N-C26D-FF KWY
AP-ME151N-C3
AP-ME151NKA-PR-C26D
AP-ME151NKA-PR-C3
AP-ME151NSA-C26D
AP-ME151NSA-C3

LOCKABLE THUMBTURN DEADBOLT

AP-ME111N-77CC-26D-SA
AP-ME111N-77CC-C3-SA-LT
AP-ME155N-C26D
AP-ME155N-C26D-FF
AP-ME155N-C3
AP-ME155NKA-PR-C26DN
AP-ME155NSA-C26

CYLINDERS

KEY-IN-KNOB CYLINDERS



MORTISE & RIM CYLINDERS



LOCKABLE THUMBTURN



APPLICATIONS:

KNOB TYPE CYLINDERS ARE DESIGNED TO RETROFIT CYLINDRICAL LOCKSETS, PADLOCKS AND DEADBOLTS. CYLINDERS ARE SUPPLIED WITH TAIL PIECES FOR THE MOST COMMON APPLICATIONS.

FITS SCHLAGE A,D SERIES, PROTEC

AP-CY406N-77CC-26D-SA
AP-CY406N-77CC-C3-SA
AP-CY406N-C26D
AP-CY406N-C26D-FF
AP-CY406NKA-PR-C26D
AP-CY406NSA-C26D

FITS WEISER DEADBOLTS

AP-CY409NSA-C26D

FITS SCHLAGE B160N DEADBOLT, PROTEC

AP-CY410N-77CC-26D-SA

APPLICATIONS:

FOR USE IN RIM AND MORTISE LOCK CASES MADE ACCORDING TO THE ANSI STANDARD

AP-CY402N-C26D	1"
AP-CY402N-C26D-FF	1"
AP-CY402NKA-PR-C26D	1" KA
AP-CY402NKA-PR-C26D-FF	1" KA
AP-CY402NSA-C26D	1" SA
AP-CY403N-C26D	1 1/4"
AP-CY403N-C26D-FF	1 1/4"
AP-CY403NKA-PR-C26D	1 1/4" KA
AP-CY403NSA-C26D	1 1/4" SA
AP-CY415NSA-C26D	1 1/8" SA

APPLICATIONS:

THIS ANSI STANDARD MORTISE CYLINDER WILL FIT ANYWHERE A REGULAR MORTISE CYLINDER WOULD APPLY. ANY STANDARD CAM CAN BE USED, COMES WITH A ADAMS-RITE CAM.

AP-CY813-77CC-26D-SA
(1", PROTEC)

ELECTRIC DEADLATCH



The EL410 are especially suitable for use in commercial premises, apartment buildings and ideal for automatic door installations.

Features include UL approved, monitored bolt and RQE integral switch. Available in 12VDC or 24VDC, fail-safe or fail-secure, and 31/32" or 1 1/8" backset.

AB-EL410-118-12VDC-LH-ELECTRIC LATCH
AB-EL410-118-12VDC-RH-ELECTRIC LATCH
AB-EL410-31/32-12VDC-LH-ELECTRIC LATCH
AB-EL410-31/32-12VDC-RH-ELECTRIC LATCH

PADLOCKS

Multi-purpose padlock of durable construction. Applications include storage room doors, power station switches, gates, cycles etc. Rekeyable or non-rekeyable cylinders.

48 mm chrome-plated brass body
8 mm diameter chrome-plated case-hardened boron steel shackle
Shackle clearance height: 25 mm or 50 mm
Toe and heel locking using stainless steel balls
First disc material: case-hardened steel
Key removable in locked position only
Number of discs: 11. Can be master keyed with other ABLOY® PROTEC locks



AP-PL330-25N	2" BODY 1" SHACKLE
AP-PL330-25NSA	2" BODY 1" SHACKLE SA
AP-PL330-50N	2" BODY 2" SHACKLE KD
AP-PL330-50NSA	2" BODY 2" SHACKLE SA
AP-PL340-25N	2 1/4" STEEL BODY 1" SHACKLE
AP-PL340-25NSA	2 1/4" STEEL BODY 1" SHACKLE SA
AP-PL340-50N	2 1/4" STEEL BODY 2" SHACKLE
AP-PL340-50NSA	2 1/4" STEEL BODY 2" SHACKLE SA
AP-PL341-25N	2 1/4" BRASS BODY 1" SHACKL
AP-PL341-25NSA	2 1/4" BRASS BODY 1" SHACK SA
AP-PL341-50N	2 1/4" BRASS BODY 2" SHACKLE
AP-PL341-50NSA	2 1/4" BRASS BODY 2" SHAC SA

DISCS AND KEY BLANKS

AP-417860 MASTER DISC # 1-3-5 25/PKG
 AP-417861 MASTER DISC # 1-3-6 25/PKG
 AP-417862 MASTER DISC # 1-4-5 25/PKG
 AP-417863 MASTER DISC # 1-4-6 25/PKG
 AP-417864 MASTER DISC # 1-5-6 25/PKG
 AP-417865 MASTER DISC # 2-3-4 25/PKG
 AP-417866 MASTER DISC # 2-3-5 25/PKG
 AP-417867 MASTER DISC # 2-3-6 25/PKG
 AP-417868 MASTER DISC # 2-4-5 25/PKG
 AP-417869 MASTER DISC # 2-4-6 25/PKG
 AP-417870 MASTER DISC # 2-5-6 25/PKG
 AP-417871 MASTER DISC # 3-4-5 25/PKG
 AP-417872 MASTER DISC # 3-4-6 25/PKG
 AP-417873 MASTER DISC # 3-5-6 25/PKG
 AP-417874 MASTER DISC # 4-5-6 25/PKG
 AP-417878 MASTER DISC # 1-2-4-5 25/PKG

AP-416774 CYL WASHER(BLACK)0.4MM 100/PKG
 AP-416775 CYL.WASHER(GOLD) 0.5MM 100/PKG
 AP-416776 PROTEC CYL DISC # 1 100/PKG
 AP-416777 PROTEC CYL DISC # 2 100/PKG
 AP-416778 PROTEC CYL DISC # 3 100/PKG
 AP-416779 PROTEC CYL DISC # 4 100/PKG
 AP-416780 PROTEC CYL DISC # 5 100/PKG
 AP-416781 PROTEC CYL DISC # 6 100/PKG
 AP-416792 PROFILE UPPER "O" CYL DISC
 AP-416795 PROFILE CYL DISC CC 25/PKG
 AP-416814 MASTER DISC # 1-2 25/PKG
 AP-416815 MASTER DISC # 1-3 25/PKG
 AP-416816 MASTER DISC # 1-4 25/PKG
 AP-416817 MASTER DISC # 1-5 25/PKG
 AP-416818 MASTER DISC # 1-6 25/PKG
 AP-416819 MASTER DISC # 2-3 25/PKG
 AP-416820 MASTER DISC # 2-4 25/PKG
 AP-416821 MASTER DISC # 2-5 25/PKG
 AP-416822 MASTER DISC # 2-6 25/PKG
 AP-416823 MASTER DISC # 3-4 25/PKG
 AP-416824 MASTER DISC # 3-5 25/PKG
 AP-416825 MASTER DISC # 3-6 25/PKG
 AP-416826 MASTER DISC # 4-5 25/PKG
 AP-416827 MASTER DISC # 4-6 25/PKG
 AP-416828 MASTER DISC # 5-6 25/PKG
 AP-416829 MASTER DISC # 1-2-3 25/PKG
 AP-416830 MASTER DISC # 1-2-4 25/PKG

AP-NB77CC
 AP-NB77FF-COUPÉ

KEY BLANK CC KEYWAY
 CUT KEY KEYWAY 77FF



AP-416831 MASTER DISC # 1-2-5 25/PKG
 AP-416832 MASTER DISC # 1-2-6 25/PKG
 AP-416833 MASTER DISC # 1-3-4 25/PKG
 AP-416834 MASTER DISC # 1-3-5 25/PKG
 AP-416835 MASTER DISC # 1-3-6 25/PKG
 AP-416836 MASTER DISC # 1-4-5 25/PKG
 AP-416837 MASTER DISC # 1-4-6 25/PKG
 AP-416838 MASTER DISC # 1-5-6 25/PKG
 AP-416839 MASTER DISC # 2-3-4 25/PKG
 AP-416840 MASTER DISC # 2-3-5 25/PKG
 AP-416841 MASTER DISC # 2-3-6 25/PKG
 AP-416842 MASTER DISC # 2-4-5 25/PKG
 AP-416843 MASTER DISC # 2-4-6 25/PKG
 AP-416844 MASTER DISC # 2-5-6 25/PKG
 AP-416845 MASTER DISC # 3-4-5 25/PKG
 AP-416846 MASTER DISC # 3-4-6 25/PKG
 AP-416847 MASTER DISC # 3-5-6 25/PKG
 AP-416848 MASTER DISC # 4-5-6 25/PKG
 AP-417812 PROTEC INDUST. DISC #3 100/PKG
 AP-417817 PROFILE UPPER "O" IND RH
 AP-417821 PROFILE BOTTOM "O" CC
 AP-417824 PROFILE BOTTOM "O" FF
 AP-417855 MASTER DISC # 1-2-3 25/PKG
 AP-417856 MASTER DISC # 1-2-4 25/PKG
 AP-417857 MASTER DISC # 1-2-5 25/PKG
 AP-417858 MASTER DISC # 1-2-6 25/PKG
 AP-417859 MASTER DISC # 1-3-4 25/PKG

55 SERIES - SOLID BRASS ECONOMY PADLOCKS

The ABUS 55 solid brass padlocks are designed for hard outdoor use, and provide reliable service in all-weather conditions.

- Solid brass construction
- Non-corrosive lock mechanism for maximum weather resistance.
- Chrome plated hardened steel shackle to maximize cutting resistance and minimize rust and corrosion.
- Double locking
- Keyed differently and keyed alike
- 4-pin tumbler

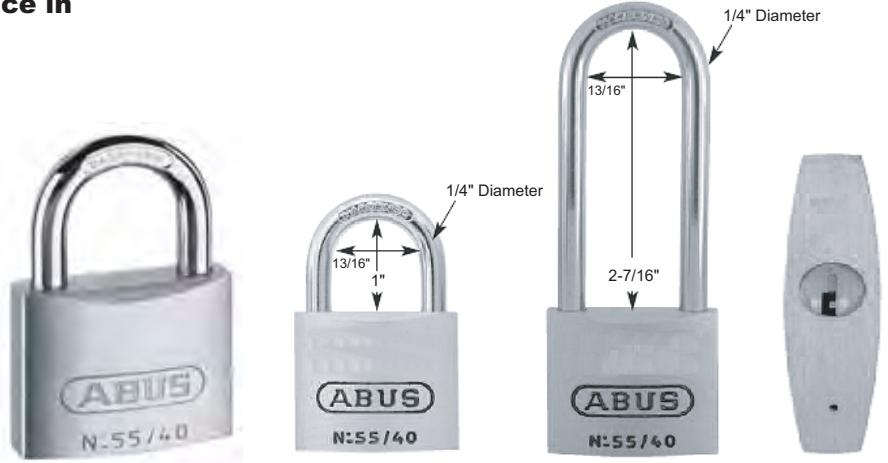

25MM	30MM	40MM	50MM	60MM
		KEYED DIFFERENT		
AU-5525-CARDED	AU-5530-CARDED	AU-5540-CARDED	AU-5550-CARDED	AU-5560-CARDED
		KEYED ALIKE		
AU-5525KA-5251	AU-5530KA-5301	AU-5540KA-5401	AU-5550KA-5501	AU-5560KA-5601
AU-5525KA-5252	AU-5530KA-5302	AU-5540KA-5402	AU-5550KA-5502	AU-5560KA-5602
	AU-5530KA-5303	AU-5540KA-5403	AU-5550KA-5503	
	AU-5530KA-5304	AU-5540KA-5404	AU-5550KA-5504	
	AU-5540KA-5405	AU-5550KA-5505	AU-5550KA-5505	
		AU-5540KA-5406		

LONG SHACKLE PADLOCK - 40MM BODY - 2-7/16" SHACKLE

AU-55HB40-63-CARDED	KEYED DIFFERENT
AU-55HB40-63KA-5401	KEYED ALIKE
AU-55HB40-63KA-5402	KEYED ALIKE

65 SERIES - SOLID BRASS PADLOCKS

The ABUS 65 solid brass padlocks are designed for hard outdoor use, and provide reliable service in all-weather conditions.

- Larger solid brass body
- Paracentric keyway provides protection from picking
- Precision keyway for thousands of key different
- Non-corrosive lock mechanism for maximum weather resistance.
- Chrome plated hardened steel shackle to maximize cutting resistance and minimize rust and corrosion.
- Heel and Toe bolting for added strength
- Keyed different and keyed alike
- 5-pin tumbler

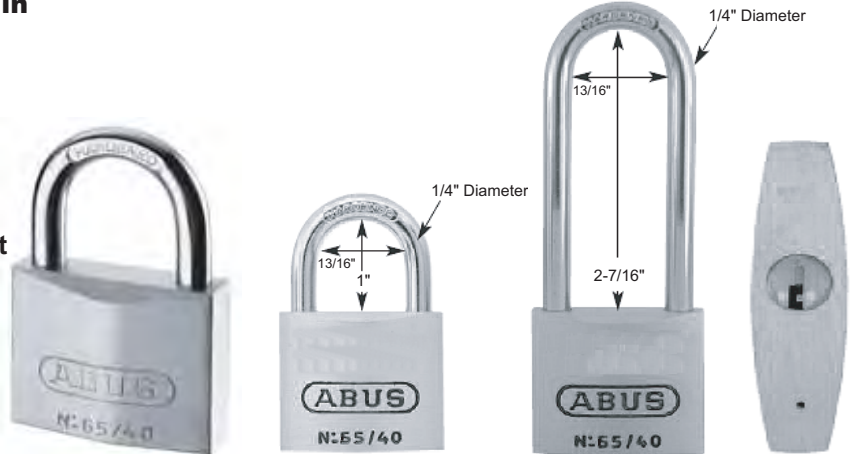

20MM

6520-CARDED
6520KA-201
6520KA-202
6520KA-203

25MM

6525-CARDED
6525KA-251
6525KA-252
6525KA-253

30MM

6530-CARDED
6530KA-301
6530KA-302
6530KA-303
6530KA-304
6530KA-305

Paracentric Keyway
6530KA-6301

40MM

6540-CARDED
6540-TWIN-CARDED
6540KA-401
6540KA-402
6540KA-403
6540KA-404
6540KA-405
6540KA-406
6540KA-407
6540KA-408
6540KA-409
6540KA-410

MASTER KEYED
AU-6540MK-65401

(2.5" SHACKLE)
65HB40-CARDED
65HB40KA-63-4100
65HB40KA-63-4101
65HB40KA-63-4102
65HB40KA-63-4103
65HB40KA-63-4104
65HB40KA-63-401

40MM

65HB40KA-63-402
65HB40KA-63-406
65HB40KA-63-409
65HB40KA-63-410

Paracentric Keyway
6540-CARDED
6540-TWIN-CARDED
6540KA-6401
6540KA-6402
6540KA-6403
6540KA-6404
6540KA-6405
6540KA-6406
6540KA-6407

2-7/16" SHACKLE
65HB40-63-CARDED
65HB40-63KA-6401
65HB40-63KA-6402
65HB40-63KA-6403
65HB40-63KA-6404
65HB40-63KA-6405
65HB40-63KA-6406

45MM

Paracentric Keyway
6545-CARDED
6545KA-6451

6545KA-451
6545KA-452
6545KA-453
6545KA-454
6545KA-455
6545KA-456

60MM

6550KA-406
6550KA-505
6550KA-507
6550KA-5100
6550KA-5101
6550KA-5102
6550KA-5103
6550KA-5104

50MM

Paracentric Keyway
6550-CARDED
6550KA-6502
(3" SHACKLE)
65HB50-80KA-6501
65HB50-80KA-6502

60MM

6560KA-601
6560KA-602

Paracentric Keyway
6560-CARDED
6560KA-6601

Sub-Assembled

65HB40KA-63-SA-191-KWY

Bottom Pins

AU-BP6540-1 #1
AU-BP6540-2 #2
AU-BP6540-3 #3
AU-BP6540-4 #4
AU-BP6540-5 #5

Top Pins

AU-TP6540

Springs

AU-S6540

Pin Hole Plugs

AU-PHP6540

Pinning Kit

AU-65-PINNINGKIT

72 SERIES - ALUMINUM SAFETY LOCK-OUT PADLOCKS

FEATURES

- highest quality color anodized 40 mm aluminum bodies, ideal for laser engraving
- six standard colors: blue, red, green, silver, yellow, black, bronze and violet
- re-keyable
- Pinning kit shown below
- high precision 6-pin cylinder for large number of key differs
- cylinders fully interchangeable with American 1105 and 1165 cylinders
- faster re-keying through use of cylinder retainer barrel instead of retainer plate
- available (In stock KD, 0 bitted) & by (Special order KA, MK)



BODY WIDTH
1 1/2" or 40mm

INSIDE SHACKLE CLEARANCE
3/4"W X 1"H

AU-7240-GREEN-LC
AU-7240-ORANGE-LC
AU-7240-YELLOW-LC
AU-7240-BLUE-LC
AU-7240-BLACK-LC
AU-7240-RED-LC
AU-7240-BRONZE-LC
AU-7240-VIOLET-LC



BODY WIDTH
1 1/2" or 40mm

INSIDE SHACKLE CLEARANCE
3/4"W X 1 1/2"H

AU-72HB40-40-GREEN-LC
AU-72HB40-40-ORANGE-LC
AU-72HB40-40-YELLOW-LC
AU-72HB40-40-BLUE-LC
AU-72HB40-40-BLACK-LC
AU-72HB40-40-RED-LC
AU-72HB40-40-BRONZE-LC
AU-72HB40-40-VIOLET-LC



72 SERIES CYLINDERS

AU-72PART-AL-CYL-0BITTED
(AMERICAN 1045 KWY) CYLINDER ONLY

AU-72PART-AL-CYL-KD
(AMERICAN 1045 KWY) CYLINDER ONLY

AU-72PART-RH-CYL-0BITTED
(RH PARACENTRIC KWY) CYLINDER ONLY

AU-72PART-RH-CYL-KD
(RH PARACENTRIC KWY) CYLINDER ONLY



PIN KIT

AU-72-PINKIT-PARACENTRIC

REPLACEMENT PINS

AU-72PART-RH-BP-1
AU-72PART-RH-BP-2
AU-72PART-RH-BP-3
AU-72PART-RH-BP-4
AU-72PART-RH-BP-5

TOP PINS & SPRINGS

AU-72PART-RH-PIN-SPRING
AU-72PART-RH-TOP-MUSH-PIN
AU-72PART-RH-TOP-PIN

KEY BLANKS

AU-KBB7240-RH
(RH PARACENTRIC) KEYBLANKS

SHACKLES

AU-7240-75MM-SHACKLE
3" (75mm) SHACKLE ONLY

PIN KIT

AU-72-PINKIT-PARACENTRIC
FOR RH, W25 KEYWAY

REPLACEMENT PINS

AU-72PART-AL-BP-1
AU-72PART-AL-BP-2
AU-72PART-AL-BP-3
AU-72PART-AL-BP-4
AU-72PART-AL-BP-5

TOP PINS & SPRINGS

AU-72PART-AL-PIN-SPRING
AU-72PART-AL-TOP-MUSH-PIN
AU-72PART-AL-TOP-PIN

PIN KIT

AU-72-PINKIT-AMERICAN

REPLACEMENT PINS

AU-72PART-AL-BP-1
AU-72PART-AL-BP-2
AU-72PART-AL-BP-3
AU-72PART-AL-BP-4
AU-72PART-AL-BP-5

TOP PINS & SPRINGS

AU-72PART-AL-PIN-SPRING
AU-72PART-AL-TOP-MUSH-PIN
AU-72PART-AL-TOP-PIN

ORIGINAL DISKUS - 24 SERIES



- Stainless Steel Lock Body
- Stainless Steel Internal Parts
- Hardened Steel Shackle
- Top Quality Weld Seam - Maximum Weld Penetration Provides High Tensile Strength
- Anti-pick Mushroom Pins
- 24/60 Features a Stainless Steel Shackle
- Shackle Clearance H-1/2" x W-3/4" x Dia. 5/16"

60mm BODY

AU-2460-CARDED	KEYED DIFFERENT
AU-2460KA-EE0123	KEYED ALIKE
AU-2460KA-EE0140	KEYED ALIKE

DISKUS WITH DRILL PROTECTION - 26 SERIES



- Stainless Steel Lock Body
- Stainless Steel Internal Parts
- Hardened Chrome Moly Shackle
- Top Quality Weld Seam - Maximum Weld Penetration Provides High Tensile Strength
- Anti-pick mushroom pins
- Hardened Steel Drill Plate Protects The Keyway

70mm BODY

AU-2670-BOXED	KEYED DIFFERENT
AU-2670-CARDED	KEYED DIFFERENT
AU-2670KA-EE0113	KEYED ALIKE
AU-2670KA-EE0121	KEYED ALIKE
AU-2670KA-EE0123	KEYED ALIKE
AU-2670KA-EE0140	KEYED ALIKE

90mm BODY

AU-2690-BOXED	KEYED DIFFERENT
AU-2690KA-0293	KEYED ALIKE
AU-2690KA-RR00471	KEYED ALIKE

SHACKLE CLEARANCE

	H	x	W	x	Dia.
70MM	3/4"		3/4"		3/8"
90MM	5-8"		1"		15/32"

BUFFO - 28 SERIES

ABUS



- Stainless body
- Yellow zinc internal components
- Hardened steel shackle
- Top-quality weld seam (maximum depth of welding gives high tensile strength)
- Anti-pick mushroom pins
- Recommended in use with 140/120 Series hasps
- Shackle Clearance H-1/2" x W-3/4" x Dia. 5/16"

70mm BODY

AU-2870-BOXED KEYED DIFFERENT

AU-2870KA-0021 KEYED ALIKE

AU-2870KA-0026 KEYED ALIKE

EXTREME SECURITY DISKUS - 20 SERIES

ABUS

The Ultimate in Diskus Protection & Strength



- Stainless Steel Lock Body
- Hardened Chrome Moly Shackle
- Top Quality Weld Seam - Maximum Weld Penetration Provides High Tensile Strength
- Features ABUS 6 Disc Plus Cylinder
- Key-Retaining For Added Security



AU-2070-KA-2072 70mm BODY (PLUS KEYWAY #163365)

BLACK GOLD SOLID BRASS - T84 SERIES

- Solid brass body with stylish protector
- Brass shackle for added corrosion resistance
- Paracentric keyway provides protection from picking
- Heel and toe bolting for added strength
- Black vinyl sheath for added protection



25 MM
AU-T84MB25C
(3 PER CARD KA)

30MM
AU-T84MB30C
AU-T84MB30C-3
(2 PER CARD KA)

40MM
AU-T84MB40C3
AU-T84MB40C-2
(2 PER CARD KA)



MAXIMUM SECURITY BRASS - 88 SERIES

- Solid brass body with a chrome-plated finish
- Double-steel ball locking mechanism for high tensile and torsion strength
- Specified as Class 2 security by the world's most demanding law-enforcement agencies and insurance companies (Class 1 on 88-40)
- ABUS Plus cylinder keyway prevents picking and drilling
- 58 Rockwell case-hardened steel shackle
- Key-retaining for added security



AU-8840C	KEYED DIFFERENT
AU-8840KA-4351326	KEYED-ALIKE
AU-8850C	KEYED DIFFERENT
AU-8850KA-1321553	KEYED-ALIKE



WEATHERPROOF LOCK - 70 SERIES

AU-70-45-CARDED
AU-70-45-KA-6401
AU-70-45-KA-6402
AU-70-45-KA-6406
AU-70-50-CARDED
AU-70-50-KA-6451
AU-70HB45-63-CARDED
AU-70HB45-63-KA-6401
AU-70HB45-63-KA-6402

45MM WEATHERIZED EXPEDITION PADLOCK
45MM WEATHERIZED EXPEDITION PADLOCK
45MM WEATHERIZED EXPEDITION PADLOCK
45MM WEATHERIZED EXPEDITION PADLOCK
50MM WEATHERIZED EXPEDITION PADLOCK
50MM WEATHERIZED EXPEDITION PADLOCK
45MM WEATHERIZED EXPEDITION PADLOCK (2-1/2 INCH SHACKLE)
45MM WEATHERIZED EXPEDITION PADLOCK (2-1/2 INCH SHACKLE)
45MM WEATHERIZED EXPEDITION PADLOCK (2-1/2 INCH SHACKLE)

- Solid Brass Body
- Hardened Steel Shackle
- Weather Proof Keyway Cover
- Paracentric Keyway



RESETTABLE COMBINATION PADLOCKS



ABUS features the only Re-Settable brass padlock available with a stainless steel shackle. Features of the re-settable brass padlock includes:

- 10,000 possible combinations
- Milled brass body (not die casted) for precision action everytime
- Stainless steel shackle for the harshest of environments

AU-180IB50-CARDED
 AU-180IB50HB-63-CARDED

1" SHACKLE
 2-1/8" SHACKLE



AU-155-20 1 PER CARD
 AU-155-30 1 PER CARD



CHROME PLATED
 AU-160-40
 AU-160-50



ALL BRASS
 AU-165-30-C
 AU-165-40-C

The simple to change combination can be set to an easily remembered personal number. To lock these combination padlocks, close the shackle and scramble the code wheels. The #160 has a double bolted, hardened steel shackle. These locks are ideal for suitcases, bags, tool boxes and lockers etc.

COMBINATION PADLOCKS - 78 SERIES



- 3 DIGIT CODE
- GALVANIZED CHROMATIZED LOCKING MECHANISM
- HARDENED STEEL SHACKLE
- EASY TO READ DIAL

AU-7850-BOXED SERIALIZED (BOXED)
 AU-7850-CARDED SERIALIZED (CARDED)
 AU-78KC-50-KA-501-BOXED SERIALIZED (KEY OVERRIDE &

83 - SERIES REKEYABLE PADLOCKS

ABUS

The 83/45 padlock was the first lock in the 83 family introduced more than 5 years ago. It replaced the 80/45 and 81/45 by utilizing the "Z-Bar" which converts the padlock between key retaining and non-key retaining. Along those 5 years the 83/45 has constantly been improved to become the most popular brass re-keyable padlock with locksmiths everywhere. Each 83/45 is shipped with the cylinder of choice and a 1" high steel shackle. Other shackle lengths need to be ordered separately.

FEATURES OF THE 83 SERIES

- Patented Z-bar converts between key retaining and non-key retaining in seconds! Z-Bar®
- Stocked in the most common OEM keyways! (6 Pin O-bitted)
- Exclusive pinning window for quick rekeying
- Key-In-Knob versions come complete with 3 Drivers for all original OEM cylinders

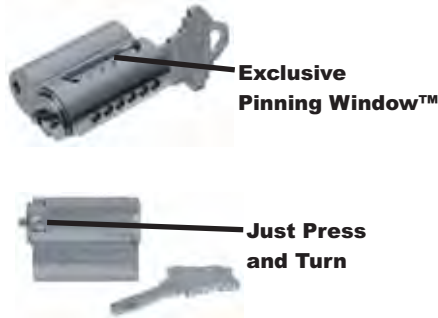

- AU-8002 2" SHACKLE FOR 83/45
- AU-8003 3" SHACKLE FOR 83/45
- AU-8004 4" SHACKLE FOR 83/45
- AU-8102 2" SHACKLE FOR 83/50
- AU-8103 3" SHACKLE FOR 83/50

AVAILABLE OEM KEYWAYS FOR ALL 83 SERIES PADLOCKS

AU-8345-PLUG-100-OBITT	YALE #9 KEYWAY
AU-8345-PLUG-1000-OBITT	D1 - D4 RUSSWIN KEYWAY
AU-8345-PLUG-200-OBITT	KWIKSET KEYWAY
AU-8345-PLUG-300-KD	SCHLAGE C KEYWAY
AU-8345-PLUG-300-OBITT	SCHLAGE C KEYWAY
AU-8345-PLUG-3000-OBITT	SCHLAGE C-K KEYWAY
AU-8345-PLUG-400-OBITT	CORBIN 60, 59A1-A2 KEYWAY
AU-8345-PLUG-6000B-0BITT	MASTER 1092-6000B KEYWAY
AU-8345-PLUG-6000B-KA-001	MASTER 1092-6000B KEYWAY10G001
AU-8345-PLUG-6000B-KA-002	MASTER 1092-6000B KEYWAY10G002
AU-8345-PLUG-6000B-KD	MASTER 1092-6000B KEYWAY KEYED DIFFERENT
AU-8345-PLUG-800-OBITT	WEISER P1555 KEYWAY
AU-8345-PLUG-900-OBITT	1022 ARROW KEYWAY

THE MOST VERSATILE SERIES OF PADLOCKS AROUND!

83 - SERIES ALUMINUM REKEYABLE PADLOCKS



- Solid aluminum body in a titanium finish
- Keys into OEM keyways
- Hardened special alloy shackle
- High-speed Pinning Window™
- Z-Bar® feature for conversion from key-retaining to non-key-retaining in seconds
- Cylinders are interchangeable among the 83/45, 83CS/45, 83AL/45, 83/50, 83/55 and 83CS/55

LASER
ENGRAVING
AVAILABLE

AU-83AL-45-TITANIUM-300	ALUMINUM REKEYABLE PADLOCK (C KEYWAY)
AU-83AL-45-TITANIUM-KNK	ALUMINUM PADLOCK (KEY-IN-KNOB CYLINDER)
AU-83AL-50-TITANIUM-300	ALUMINUM REKEYABLE PADLOCK (C KEYWAY)
AU-83AL-50-TITANIUM-KNK	ALUMINUM PADLOCK (KEY-IN-KNOB CYLINDER)

ABUS

83 - SERIES BRASS REKEYABLE PADLOCKS



- Z-Bar® feature for conversion from key-retaining to non-key-retaining in seconds
- New Pinning Window™ makes rekeying faster and easier than ever
- Additional Shackle lengths are available
- Available in OEM Keyways, SFIC and Key-in-knob

ABUS

AU-8345-1000	D1-D4 RUSSWIN KEYWAY	AU-83CS45-300	CONCEALED SHACKLE, C KEYWAY
AU-8345-100	#9 YALE KEYWAY		
AU-8345-200	1176 KWIKSET KEYWAY	AU-8345-I/C	SFIC I/C CORE
AU-8345-3000	1145L C-K KEYWAY	AU-83HB45-50MM-I/C	SFIC I/C CORE, 2-1/8" SHACKLE
AU-8345-300	1145 -C- KEYWAY		
AU-8345-400	60,59A1-A2,59B1-B2 CORBIN	AU-83HB45-75MM-300	C KEYWAY, 2.5" SHACKLE
AU-8345-6000	MASTER 1092-6000-B	AU-83HB45-75MM-800	WEISER KWY, 2.5" SHACKLE
AU-8345-700	LA-LC SARGENT KEYWAY		
AU-8345-800	1555 -W1- WEISER KEYWAY	AU-83KNK45	KEY-IN-KNOB CYLINDER
AU-8345-900	1022 ARROW KEYWAY		

83 - SERIES CHROME PLATED REKEYABLE PADLOCKS



- Solid Brass Satin-Chrome plated body
- Keys into OEM keyways
- Hardened special alloy shackle
- High-speed Pinning Window™
- Double ball locking
- Z-Bar® feature for conversion from key-retaining to non-key-retaining in seconds
- Cylinders are interchangeable among the 83/45, 83CS/45, 83AL/45, 83/50, 83/55 and 83CS/55

AU-8350-3000	C-K KEYWAY
AU-8350-300	C/1145A KEYWAY
AU-8350-800	WEISER KEYWAY
AU-83CS50-300	CONCEALED SHACKLE, C/1145A KEYWAY
AU-83CS50-I/C	SHROUDED SHACKLE, SFIC



Exclusive Pinning Window™

83 - SERIES SOLID STEEL REKEYABLE PADLOCKS



- Solid hardened steel body
- Hardened special alloy steel shackle
- High-speed Pinning Window™
- Z-Bar® feature for conversion from key-retaining to non-key-retaining in seconds
- Approved by housing authorities and correctional facilities
- Exceeds ASTM standards

AU-8355-300	THE ROCK, 1145A C KEYWAY
AU-83CS55-300	THE ROCK, CONCEALED SHACKLE, 1145A C KEYWAY
AU-83KNK55	THE ROCK, FOR KEY-IN-KNOB CYLINDERS



Exclusive Pinning Window™

83 - SERIES ROCK REKEYABLE PADLOCKS



THE ROCK

- 3.15" Wide Solid hardened steel body
- Hardened special alloy steel shackle
- High-speed Pinning Window™
- Z-Bar® feature for conversion from key-retaining to non-key-retaining in seconds
- Double ball locking



AU-8380-300

C/1145A KEYWAY

AU-8380-KNK

FOR KEY-IN-KNOB CYLINDERS

83 - SERIES Z-EXTREME WEATHER PROOF PADLOCKS

- TOUGH WEATHER RESISTANT OUTER BODY
- SOLID STEEL 53MM BODY ZINC PLATED INSIDE AND OUT, WHICH MEANS NO RUSTING!!!
- SWING-AWAY CYLINDER CAP DESIGN
- CHANNELED DRAINAGE FOR MOISTURE

STANDARD KEYWAY PADLOCKS WITH 1-1/4" SHACKLE CLEARANCE

AU-83WP53-100-0B

YALE #9 KEYWAY

AU-83WP53-300-0B

SCHLAGE C KEYWAY

AU-83WP53-300KD

SCHLAGE C, KEYED DIFFERENT

AU-83WP53-3000-0B

SCHLAGE C-K KEYWAY

AU-83WP53-700-0B

SARGENT LA-LC KEYWAY

AU-83WP53-800-0B

WEISER 1555 KEYWAY

AU-83WP53-6000B-KA-10G001

MASTER LOCK KEYED-ALIKE GROUP

AU-83WP53-6000B-KA-10G002

MASTER LOCK KEYED-ALIKE GROUP

STANDARD KEYWAY PADLOCKS WITH 2-1/2" SHACKLE CLEARANCE

AU-83WP53-HB-63MM-100-0B

YALE #9 KEYWAY

AU-83WP53-HB-63MM-300-0B

SCHLAGE C KEYWAY

AU-83WP53-HB-63MM-3000-0B

SCHLAGE C-K KEYWAY

AU-83WP53-HB-63MM-300KD

SCHLAGE C, KD

AU-83WP53-HB-63MM-700-0B

SARGENT LA-LC KEYWAY

AU-83WP53-HB-63MM-800-0B

WEISER 1555 KEYWAY

AU-83WP53-HB-63MM-6000B-KA-10G001

MASTER LOCK 1092-6000B

AU-83WP53-HB-63MM-6000B-KA-10G002

MASTER LOCK 1092-6000B



Z-EXTREME
Weather Proof Padlock

83 - SERIES Z-EXTREME SFIC & KEY-IN-KNOB



EXTREME
Weather Proof Padlock

CLAMSHELL VISUAL HANGING PACK IN "C" KEYWAY
"IDEAL FOR YOUR ABUS FLOOR & WALL DISPLAYS"

AU-83WP53-300-KD-CLAMSHELL 1-1/4" SHACKLE

AU-83WP53-HB-63-300-KD-CLAMSHELL 2-1/2" SHACKLE

SMALL FORMAT INTERCHANGEABLE CORE (SFIC)
ACCEPTS 5, 6 or 7 PIN CYLINDERS.

AU-83WP53-I/C 1-1/4" SHACKLE

AU-83WP53-I/C-HB-63 2-1/2" SHACKLE



KEY-IN-KNOB CYLINDER PADLOCKS

(ALL 3 DRIVERS INCLUDED FOR
SCHLAGE, ILCO AND MEDECO)

AU-83WP53-KNK 1-1/4" SHACKLE

AU-83WP53-KNK-HB-63 2-1/2" SHACKLE



Z-EXTREME WITH 7/16" DIAMETER SHACKLE AND A 63mm WIDTH BODY

AU-83WP63-300-0-BITT SCHLAGE C KEYWAY

AU-83WP63-6000B-KD-CARDED MASTER LOCK KEYED DIFFERENT

STANDARD KEYWAY PADLOCKS WITH 2-1/2" SHACKLE CLEARANCE

AU-83WP63-HB-63-6000B-KD MASTER LOCK 1092-6000B

SMALL FORMAT INTERCHANGEABLE CORE (SFIC)

ACCEPTS 5, 6 or 7 PIN CYLINDERS.

AU-83WP63-I/C 1-1/4" SHACKLE



KEY-IN-KNOB CYLINDER PADLOCKS

(ALL 3 DRIVERS INCLUDED FOR
SCHLAGE, ILCO AND MEDECO)



AU-83WP63-KNK 1-1/4" SHACKLE

EXTREME
Weather Proof Padlock

AU-83WP63-SHACKLE-63MM (2-1/2")

ABUS 2-1/2" SHACKLE ONLY FOR 83WP63 PADLOCK (63MM)



PREMIUM SOLID BRASS - 85 SERIES

ABUS

- **Solid brass lock body, precision brass cylinder and stainless steel springs provide maximum corrosion**
- **Paracentric keyway provides protection from picking**
- **Heel and toe bolting for added strength**
- **Keyed different, keyed alike and master keyed**
- **High-quality, weatherproof padlock**

20MM

8520KA-179
8520KA-196

30MM

8530-CARDED
8530KA-402
8530KA-418
8530KA-422
8530NKA-186
8530NKA-188

MASTER KEYED

8530MK-324
8530MK-326

SUB-ASSEMBLED

8530SA-RH-0-BITTED

40MM

8540C-CARDED
8540KA-552
8540KA-619
8540KA-706
8540KA-709
8540KA-718
8540KA-727
8540KA-729
8540KA-990
8540KA-992

MASTER KEYED

8540MK-0408
8540MK-0422

BOXED

8540-BOXED
8540NKA-367
8540NKA-461
8540NKA-643
8540NKA-670
8540NKA-781

SUB-ASSEMBLED

8540SA-RH-0-BITTED
40MM, 2.5" SHACKLE
85HB40-63C-CARDED
85HB40-63KA-706
85HB40-63KA-709
85HB40-63KA-727

BOXED 2.5" SHACKLE

85HB40-63N-BOXED
85HB40-63NKA-367
85HB40-63NKA-461

50MM

8550C-CARDED
8550KA-1587
8550KA-1598
8550KA-1672
8550KA-2669
8550KA-2726
8550KA-2747
8550KA-2808
8550KA-0503
8550KA-0506
8550N-BOXED
8550NKA-1020
8550NKA-1055
8550NKA-1088
8550NKA-954



SUB-ASSEMBLED

8550SA-RH-0-BITTED

50MM, 3.25" SHACKLE

85HB50-80KA-1672
85HB50-80KA-2726
85HB50-80KA-BM0102
85HB50-80N-BOXED
85HB50-80NKA-1020

50MM, 5" SHACKLE

85HB50-127-KA-1672

60MM-SUB-ASSEMBLED

8560SA-RH

40MM - BRASS SHACKLE

85MB40KA-3
85MB40KA-6
85MB40KA-8

50MM - BRASS SHACKLE

85MB50KA-4721
85MB50KA-6

PINS & PARTS - 85 SERIES

8540 SERIES BOTTOM PINS

AU-01358-4 #1
 AU-01370-6 #2
 AU-01382-9 #3
 AU-00219-9 #4
 AU-01390-4 #5
 AU-01391-1 #6

8550 SERIES BOTTOM PINS

AU-43678-9 #1
 AU-43679-6 #2
 AU-43680-2 #3
 AU-43681-9 #4
 AU-43682-6 #5
 AU-43672-7 #6

SHACKLE RETAINING PINS

AU-42862-3 85/40
 AU-42863-0 85/50

PLUG RETAINING PINS

AU-42871-5 85/40
 AU-42872-2 85/50

MUSHROOM PINS

AU-42844-9 85/40
 AU-42777-0 85/50

PIN SPRINGS

AU-42841-8 85/40
 AU-42770-1 85/50

REPINNING TOOLS

AU-85-SERIES-TOOLS



REPLACEMENT SHACKLES

8540-212 2.5" SHACKLE FOR THE 8540SA
 8550-314 3.25" SHACKLE FOR THE 8550SA



STAINLESS STEEL PREMIUM PADLOCK - 90 SERIES



- LOCK BODY AND SHACKLE MADE OF STAINLESS STEEL
- ALL CORROSION FREE COMPONENTS
- DOUBLE BALL BEARING FOR TORSION STRENGTH
- SHROUDED BODY PROTECTS SHACKLE
- MUSHROOM PINS FOR IMPROVED PICKING RESISTANCE
- PARACENTRIC KEYWAY PROTECTS AGAINST MANIPULATION

AU-9050C KEYED DIFFERENT, CARDED
 AU-9050KA-8531 KEYED-ALIKE, BOXED
 AU-9050KA-8532 KEYED-ALIKE, BOXED

GRANIT EXTREME SECURITY STEEL - 37 SERIES



- THE STRONGEST PADLOCK AVAILABLE WITH OVER 25,000 POUNDS OF TENSILE STRENGTH
- 65 ROCKWELL CORE-HARDENED LOCK BODY
- SHACKLE RESISTS FREON SPRAY
- ABUS 7 DISC PLUS CYLINDER
- KEY-RETAINING FOR ADDED SECURITY

AU-37-55HB50-KA-1321551 2" SHACKLE
 AU-37-60HB70 MOTORCYCLE BRAKE LOCK
 AU-37KEY ABUS CUT KEY

HASPS

Don't compromise the quality of ABUS padlocks with anything less than an ABUS hasp. ABUS offers a range of the most secure and versatile hasps available. Unique design and superior construction protects against the most common, the most ingenious and the most brutal attacks.

• Vending • Garages • Cabinets • Doors • Sheds • Tool Boxes



AU-100-60 2 1/2" LENGTH
 AU-100-80 3" LENGTH
 AU-100-100 4" LENGTH

AU-110-155 6 1/2" LENGTH
 AU-110-195 7 3/4" LENGTH
 AU-110-230 9 1/4" LENGTH

AU-140-120C 4 3/4" LENGTH
 AU-140-190C 7 1/2" LENGTH

AU-200-75 3" LENGTH
 AU-200-95 3 3/4" LENGTH
 AU-200-115 4 1/2" LENGTH
 AU-200-155 6 1/2" LENGTH

SECURITY CHAINS



MULTI PURPOSE CHAIN ASSORTMENT

- Top value for your money
- Hardened square section steel links
- High quality textile sleeve with fraying protection
- Ideal for use with ABUS padlocks

Order #	Length	Link Thickness
AU-10KS110	43"	10mm
AU-10KS140	55"	10mm
AU-10KS170	67"	10mm
AU-10KS200	78"	10mm
AU-8KS110	43"	8mm
AU-8KS85	33"	8mm
AU-6KS65	25"	6mm
AU-6KS85	33"	6mm

SECURITY COBRA CABLES

IDEAL FOR SECURING BICYCLES, LADDERS ATV'S, PATIO FURNITURE SNOWMOBILES ETC..

- FLEXIBLE STEEL CABLE
- 133 STRANDS OF HI-TECH STEEL ALLOY
- WEATHER RESISTANT COVERING
- DIFFERENT LENGTHS AVAILABLE



AU-8-200	5/16" DIA. X 6.5' LENGTH
AU-10-200	3/8" DIA. X 6.5' LENGTH
AU-10-500	3/8" DIA. X 16' LENGTH
AU-10-1000	3/8" DIA. X 32' LENGTH
AU-12-120	1/2" DIA. X 4' LENGTH
AU-20-500	3/4" DIA. X 16' LENGTH
AU-20-1000	3/4" DIA. X 32' LENGTH

FLOOR ANCHOR



AU-WBA100

Secures in garages, cellars etc. Highly resistant to all kinds of attack. Can be used in and outdoors. 16mm thick loop, 75mm x 65mm internal dimension of loop. Simple, very strong and very permanent 4 bolt fixing to the ground or floor. The corrosion resistant 16mm thick hardened steel shackle has unbelievably high levels of sawing and bolt cutting resistance.

FILE BAR SECURITY

ABUS FILE BAR

Innovative File Bar



The new ABUS File Bar has enclosed ends which give it a modern look. These enclosed ends also greatly reduce potential shipping damages. There is a conveniently located knob in the center of the file bar for easy and smooth operation. The file bars can be mounted on the right and left side by simply reversing this knob. There is no longer any need to disassemble the bar. The ABUS File Bar is constructed of heavy 16 gauge steel. All the hinges are locking lugs of 16 gauge steel. All mount screws are included with each bar.



Available for 1, 2, 3, 4 and 5 drawer cabinets



Enclosed end for added security and a modern look



Convenient knob for easy and smooth operation

- Available in 1, 2, 3, 4 and 5 drawer cabinets
- Inner and outer bar are finished in power-coat finish
- Constructed of heavy 16-gauge steel
- Built in spring-loaded hinge
- Mounting screws included

AU-ML1	11" LENGTH
AU-ML2	21.5" LENGTH
AU-ML3	33.5" LENGTH
AU-ML4	45" LENGTH
AU-ML5	56" LENGTH

SERIES 1100 ELECTRIC HINGES/PIVOTS COMPARISON CHART

ACSI Series 1100 Electric Hinges/Pivots are designed for doors that require concealed low voltage current transfer, concealed electric monitoring, or concealed low voltage current transfer with monitoring.

ACSI	STANLEY	HAGER	McKINNEY
1104	CE-54	ETW-4	CC-4
1106	CE-56	ETW-4	CC-6
1108	CE-58	ETW-8	CC-8
1110	CS	EMN	CS
1114	CECS-54	ETM-4	CSCC-4
1116	CECS-56	ETM-6	CSCC-6
1118	CECS-58	ETM-8	CSCC-8



SERIES 1500 ELECTRIC LOCK & EXIT DEVICE COMPARISON CHARTS

ELECTRIC LOCKS

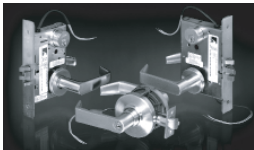

ACSI supplies high quality UL Listed modifications to a wide range of manufacturers locksets. Series 1500 electric locks provide safety and security for stairtower doors or controlled areas where both locking and latching are required. The Series 1500 locks allow remote electric locking or unlocking while conforming to life-safety codes.

ACSI	CORBIN-RUSSWIN	SCHLAGE	YALE	SARGENT	BEST	FALCON
M1510C-00-1	ML20903	L9080EL	8790	18-8270	35H7EWEL	LM851
M1510C-00-2	ML20901	L9082EL	8794-2	18-8272	35H7WWEL	LM811
M1520C-00-1	ML20905	L9080EU	8791	18-8271	35H7EWEU	LM881
M1520C-00-2	ML20904	L9082EU	8795-2	18-8273	35H7WWEU	LM821
C1510C-00-1	CL33903	D80PDEL		10G70		
C1520C-00-1	CL33905	D80PDEU		10G71		

ELECTRIC EXIT DEVICES

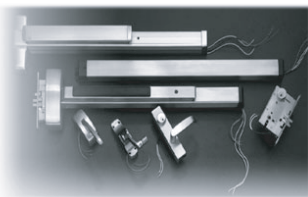

ACSI supplies high quality UL Listed modifications to a wide range of manufacturer's locksets. Series 1500 electric locks provide safety and security for stairtower doors or controlled areas where both locking and latching are required. The Series 1500 locks allow remote electric locking or unlocking while conforming to life-safety codes.

MANUFACTURER	LATCH RETRACTION PART NO.	POWER SUPPLY PART NO.	LATCHBOLT MONITOR PART NO.	REQUEST TO EXIT PART NO.
ACSI	1550	1406	LM	AE
VON DUPRIN	EL	PS873x2	LX	RX
SARGENT	56	3510	—	55
YALE	P	781N	S	B
CORBIN RUSSWIN	M94	781N	M91	B
PRECISION	ELR	ELR150	—	SS
MONARCH	ELR	RDS-2	LM, DM	
DORMA	ES	ES100	—	MS
ADAMS RITE	EL	ES100	LM	MS

ELECTRIC STRIKE ORDERING INFORMATION

FINISHES

628	CLEAR ANODIZED
313	DARK BRONZE ANODIZED
335	BLACK ANODIZED
605/632	BRIGHT BRASS
606	SATIN BRASS
611	BRIGHT BRONZE
612/639	SATIN BRONZE
10B	DARK BRONZE
626/652	SATIN CHROME
625	BRIGHT CHROME
630	SATIN STAINLESS

FAIL SAFE / FAIL SECURE
 Field reversible from one mode to the other. However, AC intermittent solenoid must not be used continuously in either.

FAIL SAFE = NO POWER, UNLOCKED
FAIL SECURE = NO POWER, LOCKED

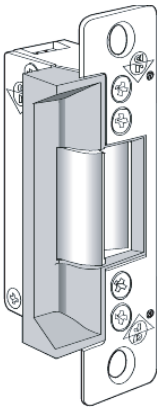

7100 SERIES ELECTRIC STRIKE

Adams Rite electric strike for use on aluminum doors. Intermittent 12VDC/24VAC. UL Listed for burglary resistance. Strike opening: 5/8" x 1-7/16" x 1/2" deep. Strike Body: 1" W x 3-3/8" H x 1-5/8" deep. Replaces earlier 002, 7510, 7810 electric releases for electrical control of any door equipped with a cylindrical or Adams Rite Series 4700 or 4500 deadlatch. Fail Safe/Fail Secure. Fits into jamb sections as shallow as 1-21/32". Aluminum Finish Only.

- AD-7103A-510-628 ELECTRIC STRIKE LESS FACEPLATE, 24VDC**
- AD-7103A-540-628 ELECTRIC STRIKE LESS FACEPLATE, 24VAC/12VDC**

7100 SERIES FACE PLATES

- AD-22-0558-652 8 INCH FACEPLATE FOR 7100 ELECTRIC STRIKES**
- AD-FPK00-628 FACEPLATE, ALUMINUM JAMB, 7103A OR 7303A**
- AD-FPK10-652 FACEPLATE, ALUM/WOOD - 8 INCH, 7103-7303**
- AD-FPK30-628 FACEPLATE, ALUM JAMB CUT FOR MS LOCK**
- AD-FPK40-628 FACEPLATE ANSI CUT OUT FOR HOLLOW METAL**

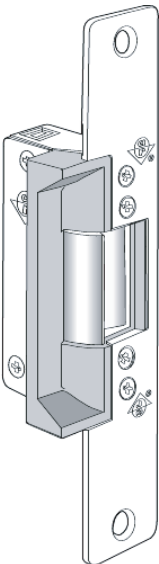

7131 SERIES ELECTRIC STRIKE

For Adams Rite or Cylindrical Latches. Remote electrical control of any narrow stile or hollow metal door equipped with an Adams Rite Series 4500 or 4700 (or similar) deadlatch. Large faceplate is designed to cover strike opening when converting from an MS pivotedbolt deadlock to a deadlatch. Electrical actuation unlocks strike jaw, releasing latchbolt so door can be opened without operating latch itself. Extremely compact mechanism fits into aluminum jamb (or opposing door) sections as shallow as 1-5/8". Fits prep for 7530/7830 Series.

- AD-7131-540-628 ELECTRIC STRIKE FOR DOUBLE RADIUS DOOR**
- AD-22-0386-652 8" FACEPLATE**

7160 / 7170 GRADE 1 FOR MORTISE & CYLINDRICAL LATCHES WITHOUT DEADBOLT

7160

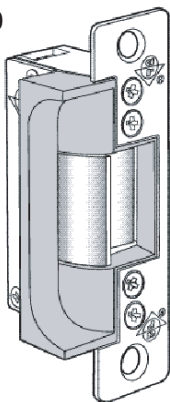

7160- MOUNTS IN ALUMINUM JAMBS , RADIUS CORNERS

7170- MOUNTS IN WOOD OR HOLLOW STEEL JAMBS, SQUARE CORNERS

CASE - 1" 3-3/8" X 1-13/16" DEEP
STRIKE OPENING - 3/4" X 1-7/16" X 3/4" DEEP.
THE BOLT RETAINER JAW IS MADE OF STAINLESS STEEL.
STRIKE ACCEPTS LATCHES OF PANIC EXIT DEVICES WHEN
IT IS CENTERED ON THE STRIKE.
(ALL 3/4" THROW LATCHES REQUIRE 1/8" OR MORE DOOR GAP)

7170

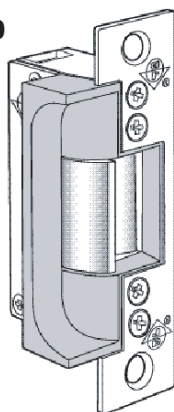

FACE PLATES

7160- RADIUS CORNERS, 1-1/4" X 4-7/8"

7170- SQUARE CORNERS, 1-1/4" X 4-7/8"

AD-7160-540-628 24VAC INTERMITTENT, FAIL SECURE, ALUMINUM FINISH

AD-7170-540-628 24VAC INTERMITTENT, FAIL SECURE, ALUMINUM FINISH



Premium.
Compact.
Inspired.



7400 ULTRALINE SERIES



The UltraLine 7400 Series provides installers an easy, practical, cutting-edge solution that increases flexibility and improves security.

Fully Featured:

- Over 2000lbs. of holding force
- Opens electrically with 30lbs. of preload
- Compact size – 11/16" overall depth
- Single solenoid operates on 12, 16, or 24 volt AC/DC power
- Field selectable – fail-secure or fail-safe
- Compatible with narrow stile, key-in-knob and rim exit device latches
- Retrofits previous Adams Rite 7500, 7800, 7000 and 7100 strikes
- Exceeds ANSI/BHMA Grade 1 standards
- Adjustable jaw
- Low current draw
- Five year limited warranty

AD-7400A	ULTRALINE STRIKE BODY ONLY (12/24VAC/DC)
AD-7401A	ULTRALINE STRIKE BODY (12/24VAC/DC)
AD-74R1-130	ULTRALINE RIM STRIKE (3/4 LATCH BOLT)
AD-74R2-130	ULTRALINE NARROW RIM STRIKE (1/2 LATCH)
AD-FPK7400-628	FACEPLATE ALUM.STILE, 1-1/4 X 4-7/8 (7401A)
AD-FPK7401-130	FACEPLATE RADIUS, 1-1/4 X 4-7/8
AD-FPK7410-628	FACEPLATE FOR WOOD, 1-7/16X10-1/4
AD-FPK7430-628	FACEPLATE ALUM JAMB, 1-1/4 X 6-7/8
AD-FPK7431-628	FACEPLATE ALUM JAMB, 1-1/4 X 6-7/8 (7401A)
AD-FPK7440-628	FACEPLATE STEEL/WOOD, 1-1/4 X 4-7/8

71R1 GRADE1 RIM ELECTRIC STRIKE

A semi-mortised strike for rim exit devices having Pullman type bolts without auxiliary bolts. Provides electrical remote control allowing door to open without actuation of the exit device. Designed to make "loiding" or "case -knife" entry as difficult as possible. Strike opening is 5/8" x 1 7/16" x 9/16" deep. Bolt retaining jaw is brass. Accepts Pullman bolt of exit devices(without deadlocking bolts) from: Von Duprin, Precision Hardware, American Device and Monarch.

- AD-71R1-510-130-99 24VDC, FAIL SECURE, ALUMINUM FINISH**
- AD-71R1-540-130-99 24VAC /12VDC, FAIL SECURE, ALUMINUM FINISH**



71R2 GRADE1 RIM ELECTRIC STRIKE FOR NARROW STYLE

A semi-mortised strike for rim exit devices having 1/2" pullman type bolts without auxiliary bolts. Provides electrical remote control allowing door to open without actuation of the exit device. Strike opening is 5/8" x 1 7/16" x 1/2" deep. Bolt retaining jaw is brass. Mounting plate measures 1 1/2" x 9" x 1/2" deep. Made of zinc/aluminum alloy. Standard finish in Ritecoast epoxy to match Clear, Dark Bronze Anodized and Black Anodized finishes. Case is approximately 1" x 3 3/8" x 1 1/8" deep. Made of zinc-aluminum alloy.

- AD-71R2-540-130-99 24VAC /12VDC, FAIL SECURE, ALUMINUM FINISH**



PARTS AND ACCESSORIES



**AD-4603 RECTIFIER,
CONVERTS AC TO DC**



**AD-4605 TRANSFORMER,
RATED AT 40 VOLT-AMP OUTPUT**

REPLACEMENT SOLENOIDS 7 PLUNGER FOR 7100 STRIKES

- AD-29-0250-12ACI 12VAC**
- AD-29-0250-12DCC 12VDC/ 24VAC**
- AD-29-0250-16ACI 16VAC**
- AD-29-0250-16DCC 16VDC**
- AD-29-0250-24DCC 24VDC**

AD-26-0170 PLUNGER FOR SOLENOID

**SERIES 8800 NARROW STILE RIM MOUNTED EXIT DEVICES
(For Narrow-Stile Glass Doors)**

Provides the convenience of easy installation with the advantage of a push bar with clean lines. Mounting is achieved by four screws which are hidden by the bar's end caps. Only four 1/4" holes are required on the inside of the door face for Rivnut(r) threaded inserts. (When outside actuation is required, fifth hole with a 1 1/4" diameter is needed). The "starwheel" bolt Series 8800 is vastly superior to those in other exit devices and achieves the highest level of security without sacrificing safety. Extra security against jamb spreading is provided by a unique nose guard which interlocks with the hardened steel strike plate.

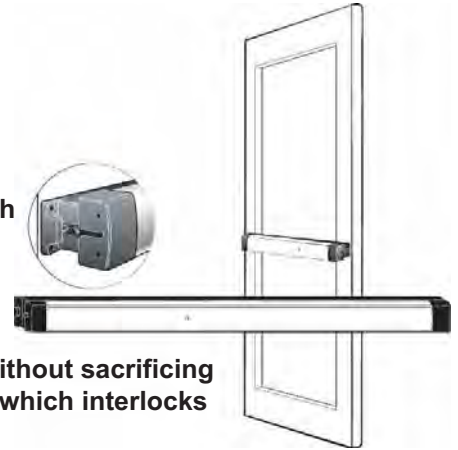

AD-8801-36 RIM EXIT DEVICE FOR NARROW STILE GLASS, ALUMINUM

**SERIES 8400 NARROW STILE MORTISE EXIT DEVICES WITH HEAVY DUTY DEADLOCKING LATCH MECHANISM
(For Narrow-Stile Glass Doors)**

For single glass doors or pairs of doors with a center mullion. Fits in the standard narrow stile cutout used for the famous Adams-Rite M.S. deadlock. Four additional 1/4" holes for threaded blind fasteners complete the simple stile preparation. Bolt throw: 5/8" backsets: 31/32" and 1-1/8" normal no load actuation requires only 8 lb. pressure anywhere along bar. At rest, bar protects 2-1/2" above stile surface. Dogging provision is by hex key furnished, requiring a single quarter turn in center of the pushbar on new style. Handing is reversible.



AD-8412-27136-RHR MORTISE PANIC DEVICE, 31/32 - 36", ALUMINUM
AD-8412-28136-LHR MORTISE PANIC DEVICE, 31/32 - 36", ALUMINUM
AD-8412-37136-RHR MORTISE PANIC DEVICE, 1-1/8 - 36", ALUMINUM
AD-8412-38136-LHR MORTISE PANIC DEVICE, 1-1/8 - 36", ALUMINUM

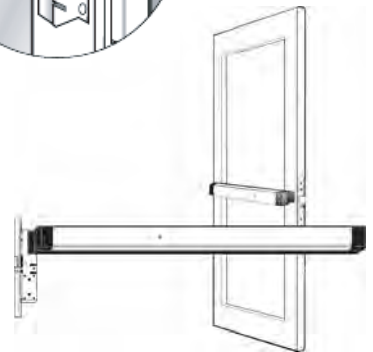

PARTS FOR 8400 AND 8800 SERIES EXIT DEVICES

AD-25-0471 ADAMS RITE END CAP FOR ALL 8000 SERIES (HINGE SIDE)
AD-25-0480 DOGGING KEY (OLD STYLE - PLASTIC)
AD-31-0265 DOGGING ASSEMBLY FOR 8000 SERIES PANIC
AD-41-0801-01-IP ACTIVE ENDCAP FOR 84-8600 SERIES (NEW)
AD-41-0801-08 8800 ACTIVE ENDCAP WITH DOGGING (OLD STYLE)
AD-29-0481 DOGGING KEY (METAL - NEW STYLE)

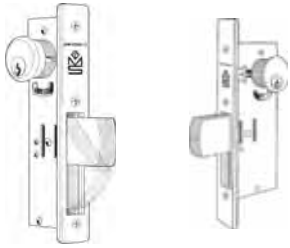

MS1850S **MS1850S**
220/320



MS1850S/N

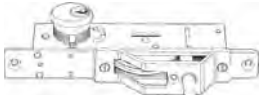

MS1861



MS1830



4070



4200 eLATCH™

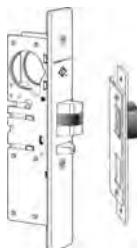

4711

MS1850 SERIES DEADBOLTS

MAXIMUM-SECURITY mortise deadlock for aluminum doors

The standard among narrow stile doors, featuring a large, laminated steel bolt, nearly 3 inches long and activated by an uncomplicated pivot mechanism. Because of its length, the bolt provides maximum security for any single leaf door, even tall and flexible ones or when the gap between the door and the jamb is greater than it should be. Individually boxed with machine screws for mounting. Cylinders and/or thumbturn available at extra cost.

Cylinder Backset: 7/8" , 31/32" , 1 1/8" , 1 1/2"

- AD-MS1850S-110-628-7/8**
- AD-MS1850S-210-628-31/32**
- AD-MS1850S-310-628-118**
- AD-MS1850S-410-628-112**

- DEADBOLT, 7/8" BACKSET**
- DEADBOLT, 31/32" BACKSET**
- DEADBOLT, 1-1/8" BACKSET**
- DEADBOLT, 1-1/2 BACKSET**

- AD-MS1850S-220-628-31/32**
- AD-MS1850S-320-628 -118**

- SHORT THROW DEADBOLT, 31/32" BACKSET**
- SHORT THROW DEADBOLT, 1-1/8" BACKSET**

- AD-MS1850S-250-628-31/32**
- AD-MS1850S-350-628-118**
- AD-MS1850SN-450-628-112**

- HOOK BOLT, 31/32" BACKSET**
- HOOK BOLT, 1-1/8" BACKSET**
- HOOK BOLT, 1-1/2" BACKSET**

AD-MS1861-01

BOTTOM RAIL DEADBOLT, SINGLE POINT

- AD-1830-02-628**
- AD-1830-03-628**

- BOTTOM-RAIL DEADLOCK , 31/32" BACKSET**
- BOTTOM-RAIL DEADLOCK , 1-1/8" BACKSET**

4070 SERIES SHORT THROW DEADBOLT - PROJECTION STYLE

Where a long-throw maximum security deadlock cannot be accommodated, the smaller 4070 deadlock offers the longest practical throw for a conventionally projected bolt from a narrow stile. Operation is via a standard mortise cylinder or thumbturn with (modified cam) from either or both sides.

- AD-4070-20-628-31/32**
- AD-4070-30-628-118**

- DEADBOLT, 31/32" BACKSET**
- DEADBOLT, 1-1/8" BACKSET**

4200 eLATCH™ ELECTRIC DEADLATCH

Electrifying a narrow stile aluminum door has never been easier or faster than with this new "no-cut" solution from Adams Rite. The eLatch is an electrified deadlatch that provides 12 or 24 volt electric unlocking capability for commercial aluminum stile and glass door entrance systems.

AD-4200-25-101-628-24VDC ELECTRIFIED DEADLATCH, 31/32" BACKSET

4000 SERIES HEAVY DUTY DEADLATCH

Offers flexible traffic control and an excellent level of security and is often used in conjunction with 7100 Series Electric Strikes to provide remote access control. The auxiliary bolt feature deadlocks the latch when the door is closed against the strike. Maximum operational door gap is 5mm. Operates using Mortise Cylinder, Thumbturn (both with MS® cam) or 4591 Paddle Handle (with 4580 cam plug). The latch is interchangeable without stile modification with the MS®1850S Deadlock. To operate "Bolt Holdback" feature, push in bolt and secure by reverse turn of the key. Latchbolt reversible; supplied non-handed unless specified.

- AD-4711-15-628** **DEADLATCH, 7/8" BACKSET - LH**
- AD-4711-16-628** **DEADLATCH, 7/8" BACKSET - RH**
- AD-4711-25-628** **DEADLATCH, 31/32" BACKSET - LH**
- AD-4711-26-628** **DEADLATCH, 31/32" BACKSET - RH**

Same as 4711 without faceplate

- AD-4513-25-MC** **HEAVY DUTY DEADLATCH ONLY, 31/32 - LH**
- AD-4513-26-MC** **HEAVY DUTY DEADLATCH ONLY, 31/32 - RH**
- AD-4513-35-MC** **HEAVY DUTY DEADLATCH ONLY, 1-1/8 -LH**
- AD-4513-36-MC** **HEAVY DUTY DEADLATCH ONLY, 1-1/8 -RH**

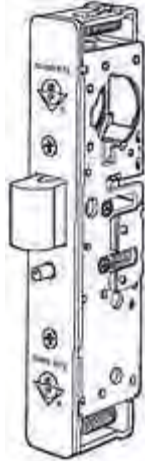

4900 SERIES HEAVY DUTY ADJUSTABLE DEADLATCH

Featuring all-metal construction, 4900 Series includes one-piece cast latch holdback and stainless steel auxiliary deadlatch pin. This 5/8 in. solid brass latchbolt can be reversed in field using screwdriver, and mounting plate bevel can be changed for flat, left-hand, or right-hand beveled doors. Supplied with flat and radius faceplates, deadlatch utilizes easy-glide rollers for smooth action of latchbolt and latchpin.

- AD-4900-35-628
- AD-4900-36-628
- AD-4900-45-628
- AD-4900-46-628

- HEAVY DEADLATCH, 1-1/8 BACKSET - LH/RHR
- HEAVY DEADLATCH, 1-1/8 BACKSET - RH/LHR
- HEAVY DEADLATCH, 1-1/2 BACKSET - LH/RHR
- HEAVY DEADLATCH, 1-1/2 BACKSET - RH/LHR

- AD-4901-01-630
- AD-4902-01-630

- DOUBLE HOLE BOX STRIKE FOR 4910 LATCH
- SINGLE HOLE BOX STRIKE FOR 4910 LATCH

- AD-24-0137-01-628
- AD-24-0137-02-628
- AD-24-0137-03-628

- FACEPLATE FOR 4900 SERIES (FLAT OR BEVEL)
- FACEPLATE FOR 4900 SERIES (RADIUS)
- FACEPLATE FOR 4900 SERIES (WEATHER-SEAL)

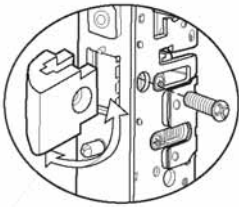

4550 SERIES LEVERS

Provides easy unlocking of MS® deadlocks by approximately 1.4kg (3lb) of downward pressure. Lever is spring-loaded to horizontal and relocks by upward motion from horizontal. Lock status is shown by indicator.

4560 SERIES LEVERS

For narrow stile doors, covers old mounting holes. Handle engages cylinder-type cam disc, which works with any 4500 or 4700 Series latch. Reversible handing and Not intended for use as a door pull.

- AD-4550-628

- MS LOCK LEVER RETROFIT (LH or RH)

- AD-4565-501-130-LH
- AD-4565-501-121-LH
- AD-4565-601-121-RH
- AD-4565-601-130-RH

- SHORT LEVER HANDLE, ALUMINUM
- SHORT LEVER HANDLE, DURODONIC
- SHORT LEVER HANDLE, DURODONIC
- SHORT LEVER HANDLE, ALUMINUM

- AD-4560-501-121-LH
- AD-4560-501-130-LH
- AD-4560-601-121-RH
- AD-4560-601-130-RH

- MEDIUM LEVER HANDLE, DURODONIC
- MEDIUM LEVER HANDLE, ALUMINUM
- MEDIUM LEVER HANDLE, DURODONIC
- MEDIUM LEVER HANDLE, ALUMINUM

- AD-4568-501-130-LH
- AD-4568-601-130-RH

- LONG LEVER HANDLE, ALUMINUM
- LONG LEVER HANDLE, ALUMINUM

- AD-4580-501-LH
- AD-4580-601-RH

- DISC CAM PLUG, LEFT HAND
- DISC CAM PLUG, RIGHT HAND

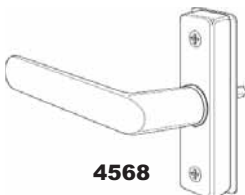



4590

4590 SERIES PADDLE HANDLES

Available to operate 4700 series latches or MS+ 1890 lock/latch. Particularly suitable for access by disabled persons: pushes or pulls in direction of door swing rather than conventional lever's down-then-out motion.

AD-4590-02-02-628
 AD-4590-02-313
 AD-4590-02-628
 AD-4590-04-313
 AD-4590-04-628

PADDLE HANDLE FOR 2 1/4 INCH DOOR
 PADDLE HANDLE, PUSH TO LEFT, DURODONIC
 PADDLE HANDLE, PUSH TO LEFT, ALUMINUM
 PADDLE HANDLE, PUSH TO RIGHT, DURODONIC
 PADDLE HANDLE, PUSH TO RIGHT, ALUMINUM



4591

AD-4591-02-313
 AD-4591-02-628
 AD-4591-04-313
 AD-4591-04-628

NEW STYLE PADDLE, PUSH TO LEFT, DURO
 NEW DESIGN PADDLE, PUSH TO LEFT, ALUMINUM
 NEW STYLE PADDLE, PUSH TO RIGHT, DURO
 NEW DESIGN PADDLE HANDLE, PUSH TO RIGHT

AD-4580-501-LH
 AD-4580-601-RH

DISC CAM PLUG, LEFT HAND
 DISC CAM PLUG, RIGHT HAND

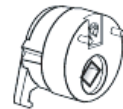

PARTS FOR DEADLATCHES, DEADBOLTS, LEVERS AND PADDLES

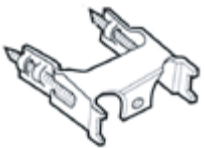

AD-4104-01
 AD-4104-02
 AD-4104-03
 AD-4104-04
 AD-4075-01

MOUNTING BRIDGE, RADIUS DOOR FACE
 MOUNTING BRIDGE, FLAT DOOR FACE
 MOUNTING BRIDGE, LH BEVEL DOOR FACE
 MOUNTING BRIDGE, RH BEVEL DOOR FACE
 INSTALLATION TOOL FOR THE 4104 BRIDGES

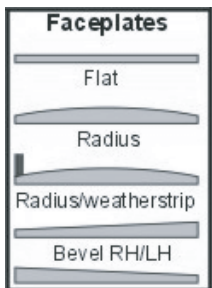

AD-24-0017-1220-313
 AD-24-0017-1220-628
 AD-24-0017-2220-313
 AD-24-0017-2220-628
 AD-24-0017-3220-628
 AD-24-0017-4220-628
 AD-24-0137-01-313
 AD-24-0137-01-628
 AD-24-0137-02-628
 AD-24-0137-03-628

RADIUS FACEPLATE FOR 4500/4700, DURODONIC
 RADIUS FACEPLATE FOR 4500/4700, DURODONIC
 BEVEL FACEPLATE FOR 4711, LEFT HAND, ALUMINUM
 BEVEL FACEPLATE FOR 4711, LEFT HAND, ALUMINUM
 BEVEL FACEPLATE FOR 4711, RIGHT HAND, ALUMINUM
 WEATHER-SEALED FACEPLATE FOR 4500/4700, ALUMINUM
 FACEPLATE FOR 4900 SERIES, FLAT OR BEVEL, DURODONIC
 FACEPLATE FOR 4900 SERIES, FLAT OR BEVEL, ALUMINUM
 RADIUS FACEPLATE FOR 4900 SERIES, ALUMINUM
 WEATHER-SEALED FACEPLATE FOR 4900 SERIES, ALUMINUM

AD-28-0061
 AD-28-0225
 AD-91-0060
 AD-HS63

DEADLATCH ARM SPRING (AD-HS6)
 POST SPRING FOR PADDLE AND LEVER (HS225)
 TOP AND BOTTOM PADDLE SPRINGS (4 SPRINGS)
 DEADLATCH- DEADPIN SPRING (BOTTOM SPRING)

AD-MS4002-012-628
 AD-S232B8-9/32N-631
 AD-S232C08-05-631
 AD-S232C8-15/32-631

ARMoured STRIKE FOR MS SERIES
 SHORT SET SCREW FOR 4711
 MEDIUM SET SCREW FOR 31/32 MS1850S
 LONG SET SCREW FOR 1-1/8 - 1-1/2 MS1850S

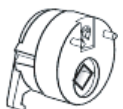

AD-4580-501-LH
 AD-4580-601-RH

DISC CAM PLUG, LEFT HAND
 DISC CAM PLUG, RIGHT HAND

Trilogy® T2 DL2700 Digital Locks

- Now in waterproof model (DL2700WP) for indoor/outdoor applications
- Clutch mechanism offers long-lasting performance and exceptional strength
- Heavy-duty trim design with self-contained, fully programmable, 12-digit metal keypad
- Non-handed for easy installation and versatility
- 2-wire remote override or key bypass capability
- Visual and audible entry indicators
- Flex-Drive motor operates latch mechanism
- Multi-level user capability
- Up to 15 different group or individual codes
- Master, manager, emergency, service codes
- Individual, group or total user lockout codes
- Available in lever or knob design with re-keyable cylinder or interchangeable core
- UL listed Grade one lockset with fire-rated latch meets or exceeds BHMA specifications
- Available in Satin chrome (26D)
- Available in interchangeable core model accepting 6 or 7 pin cores from Best, Arrow, KSP, Falcon, Medeco Keymark, Kaba Peaks, Yale, Sargent, Corbin/Russwin CL and Schlage



AA-DL2700-26D-I/C
AA-DL2700-26D
AA-DL2700-WP-26D
AA-HW571

ALARM LOCK TRILOGY FOR BEST INTERCHANGEABLE CORE
TRILOGY DIGITAL LEVER ACCESS CONTROL W/KEY OVERRIDE
ALARM LOCK TRILOGY (WEATHERPROOF)
ALARM LOCK LEVER SPRING HANDLE FOR DL2700

TRILOGY® DL2800 Audit Trail Pushbutton Lock

Rugged clutch mechanism insures long life & durability

- 150 scheduled events, including 4 "quick schedules" for programming the 4 most common time schedules in one step
- 200 User Codes including: Master, Manager, Supervisor and Basic Users. Also one-time entry code
- Weather resistant performance with operational temperature range of +151°F to -20°F
- Times entry allowance from 5-15 seconds
- Greater security with "Temporary Keypad Lockout" after 3 unsuccessful code-entry attempts
- Audit Trail with Time/Date Stamp for a printable record of all electronic activity
- Real Time Clock Allows logging of events to within 1 second of accuracy
- Relay may be programmed to energize when one or more selected events occur
- 4 Time-Out functions allow a user to enable other users or unlock the lock for some time period without needing to return to the lock
- 1000 Event Log
- Easy to install. Retrofits most cylindrical locksets and digital locks
- Battery operated; uses 5 AA batteries
- Available in standard key override and interchangeable core models accepting 6 or 7 pin cores from Arrow, Best, Falcon, or KSP. Other IC core preps available.
- Available in standard Trilogy leverset (straight)



AA-DL2800-26D **ALARM LOCK STAND ALONE LOCK (WITH AUDIT TRAIL)**

Trilogy® EXIT DEVICE TRIM

Add keyless convenience & audit trail to leading panic exit bar brands plus save manpower with auto-locking/unlocking by precise time schedules

- 2000 user codes with multilevel security - master, manager, supervisor, and basic users
- 40,000 event audit trail log, stamped by date, time and user
- 500 lock/unlock schedules (with time zone support)
- Fingertip (keypad) or Window PC programmable
- Weatherproof, rugged all-metal 12-button vandal-resistant keypad
- Non-handed; fully field reversible
- Adaptable to most major manufacturers of standard RIM and IC RIM cylinders
- 5AA battery operated

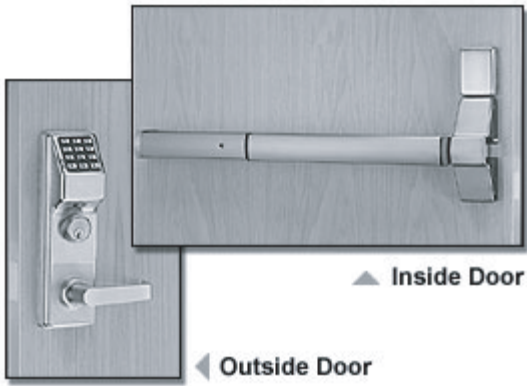

AA-ETDL-0-S-26D-V99 ALARM LOCK EXIT DEVICE EXIT TRIM (PUSHBUTTON ONLY)

TRILOGY® PDL3000 PIN/PROX CYLINDRICAL LOCK

- 2,000 PIN or PIN/PROX user codes with multilevel security - master, manager, supervisor, basic users and one-time service code.
- Users are individually programmed to use a card only, code only, or both card and code.
- Up to 40,000 event audit trail with printed time/date stamped log of all electronic activity can be extracted from the lock by using the AL-IR1 (infrared printer), the AL-DTMIII (data transfer module) or AL-PCI2 (PC interface)
- 500 scheduled automatic lock/unlock events
- Program data can be transferred to lock via AL-PCI2 (PC interface) or AL-DTMIII (data transfer module).
- Easy Tap & Add batch Prox ID card enrollment mode allows many cards to be quickly added without PC. Also downloadable from PC or Prox enroller tool.
- Fingertip (keypad) or Window PC programmable
- Durable BHMA Grade 1 lockset
- Vandal proof all-metal keypads
- Weatherproof performance with temperature range of -31° to + 151°F (-35° to 66°C)
- Non-handed for easy installation
- 5AA Battery operated; 60,000 cycles, typical.



AA-PDL3000-I/C-26D ALARM LOCK STAND ALONE CYLINDER LOCK (KEYPAD/PROX)
AA-PL3000-26D ALARM LOCK CYLINDRICAL LOCKSET (PROXIMITY READER)

TRILOGY® NARROW STILE LOCK

Alarm Lock's Trilogy family of narrow stile locks adds pushbutton convenience for 100-2,000 PIN codes or HID PROX users of aluminum doors with Adams Rite® aluminum door latch locks.

- Supports up to 2,000 PIN or PROX ID users
- Fingertip (keypad) or Window PC programmable
- 40,000 event audit trail
- 500 event schedule.

AA-PDL1300DL-D1-26D ALARM LOCK PROX/PIN NARROW STILE ACCESS LOCK





Trilogy® DATA TRANSFER MODULER

Module used to transfer program data from the PC to the lock and receive Audit Trail from the lock. Can transfer program data for up to 200 locks.

AA-AL-DTMIII ALARM LOCK DATA TRANSFER MODULE



Trilogy® PROX READER AND ENROLLER

Alarm Lock PROX Reader/Enroller (for use with PROX lock) PROX Card Reader/Enroller Enables instant, automatic enrollment of PROX Cards into DL-Windows (just tap the PROX Card/Fob device to the unit's faceplate to enroll)! Supports all Prox cards and Prox keyfobs. Simultaneous card enrollment, downloading or lock polling – all on just one serial port. Replaces AL-PCI. 9V Battery operation (6 mos. to year, typical).

AA-AL-PRE ALARM LOCK DATA TRANSFER MODULE

EMERGENCY EXIT ALARM LOCK

- Alarm Lock's Emergency Exit Surface Mounted Alarm Lock.
- U.L. Listed.
- Provides full time locking of emergency exit doors. Pressure on paddle allows exit and sounds alarm.
- 1" throw safety deadbolt.
- 6 volt battery power (furnished with battery pack). Inside accepts standard rim cylinder (not included).
- Outside rim cylinder 3-1/2" minimum length tailpiece (not included).
- Mounting plate for easy installation on all doors.

AA-11A EMERGENCY EXIT ALARM LOCK

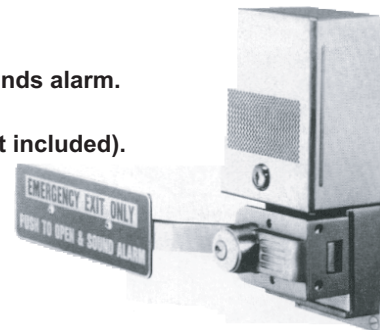

SIRENLOCK - DELAYED EGRESS EXIT ALARM

- 15 second delayed egress with instant 95db Dual Piezo alarm (meets UL specifications)
- Instant alarmed exit in case of actual emergency or fire (meets NFPA 1012 Life Safety Code)
- Easy-to-install, surface mount unit in a standard panic bar deadbolt/deadlatch design
- Monitoring output for simultaneous use of CCTV camera, secondary siren, remote monitoring console, etc.
- Smoke detector input can be used to power existing system or standalone smoke detector(s), Includes armored door cord and cables for wiring.
- 9V battery back-up powers in event of power failure

AA-715-28 PANIC EXIT ALARM WITH DELAYED EGRESS, 36"



NARROW STILE DOOR ALARM

The PG21MS Series includes advanced narrow-stile microprocessor-controlled door alarms for surface mounting on a door or door frame. Typical applications include emergency ie... escape doors, nursing home stairwell doors, rear restaurant and theater doors.

AA-PG21MS ALARM EXIT DOOR ALARM (METALLIC SILVER)
AA-PG21MS-S ALARM EXIT DOOR ALARM WITH STROBE(METALLIC SILVER)
AA-BP6 ALARM BATTERY PACK



HIDDEN SHACKLE PUCK LOCK

- Brass 6 pin with anti-pick mushroom pins to resist picking
- To be used with the A800 Hasp
- Available Keyed Different (KD) or Keyed Alike (KA)
- Satin Chrome Finish

AM-A2000-KD

AMERICAN PADLOCK (PUCK)

AM-A2000KA-80060

AMERICAN PADLOCK (PUCK) KEYED ALIKE



TRUCK AND TRAILER HASP

- A800 bolt-on hasp are made of steel for maximum strength and durability.
- This hasp is designed so that hidden shackle padlock (A2000)
- Can be attached directly to hasp for maximum convenience.
- Is designed for swinging doors
- Attached lock prevents the loss of a loose padlock

AM-A800

AMERICAN HASP FOR AM-2000



ALUMINUM SAFETY LOCKOUT PADLOCKS

Its solid aluminum body defies bolt cutters and prying with tough to cut boron alloy hardened steel shackles. The A1105/A1106 Series resists corrosion and is ideal for harsh environments. Its dual ball bearing locking mechanism resists pulling and prying. Perfect for laser engraving.

1" SHACKLE CLEARANCE, 1-1/2" WIDTH BODY

AM-A1105BLK-KD	BLACK PADLOCK
AM-A1105BLU-KD	BLUE PADLOCK
AM-A1105BRN-KD	BROWN PADLOCK
AM-A1105GRN-KD	GREEN PADLOCK
AM-A1105ORJ-KD	ORANGE PADLOCK
AM-A1105PRP-KD	PURPLE PADLOCK
AM-A1105RED-KD	RED PADLOCK
AM-A1105YLW-KD	GOLD PADLOCK



1" SHACKLE CLEARANCE, 1-1/2" WIDTH BODY, WITHOUT CYLINDER

AM-A1105BLK-WO	BLACK PADLOCK
AM-A1105BLU-WO	BLUE PADLOCK
AM-A1105BRN-WO	BROWN PADLOCK
AM-A1105GRN-WO	GREEN PADLOCK
AM-A1105ORJ-WO	ORANGE PADLOCK
AM-A1105PRP-WO	PURPLE PADLOCK
AM-A1105RED-WO	RED PADLOCK
AM-A1105YLW-WO	GOLD PADLOCK

1 1/2" SHACKLE CLEARANCE, 1-1/2" WIDTH BODY

AM-A1106BLK-KD	BLACK PADLOCK
AM-A1106BLU-KD	BLUE PADLOCK
AM-A1106BRN-KD	BROWN PADLOCK
AM-A1106GRN-KD	GREEN PADLOCK
AM-A1106ORJ-KD	ORANGE PADLOCK
AM-A1106PRP-KD	PURPLE PADLOCK
AM-A1106RED-KD	RED PADLOCK
AM-A1106YLW-KD	GOLD PADLOCK



1 1/2" SHACKLE CLEARANCE, 1-1/2" WIDTH BODY, WITHOUT CYLINDER

AM-A1106BLK-WO	BLACK PADLOCK
AM-A1106BLU-WO	BLUE PADLOCK
AM-A1106BRN-WO	BROWN PADLOCK
AM-A1106GRN-WO	GREEN PADLOCK
AM-A1106ORJ-WO	ORANGE PADLOCK
AM-A1106PRP-WO	PURPLE PADLOCK
AM-A1106RED-WO	RED PADLOCK
AM-A1106YLW-WO	GOLD PADLOCK

AM-ASK8

REKEYABLE PIN TUMBLER SERVICE KIT

AM-APKG2081160

KEY RETAINING DRIVER FOR A1105/A1106

U.L. LISTED 2 HOUR FIRE AND IMPACT SAFE



AS-ULG1511

FIRE RATED RECORD SAFE (UL - 2 HOUR - 350)

AS-ULG1511-ESL10-KEYPAD

FIRE RATED RECORD SAFE (UL - 2 HOUR - 350)

AS-ULG1812

FIRE RATED RECORD SAFE (UL - 2 HOUR - 350)

AS-ULG2018

FIRE RATED RECORD SAFE (UL 2 HOUR - 350)

FEATURES

- The best warranty in the business. Lifetime fire replacement and one year parts and labor.
- U.L. listed Class 350°F two hour fire and impact rating.
- Safes withstand fires of up to 1850°F for two hours and a 30° drop – equivalent to falling through a 2 story burning building.
- Increased barriers for burglary protection. Impressive 3-1/2" thick recessed door with 5/8" thick front for excellent pry resistance.
- Handle activated locking mechanism with 7/8" diameter solid steel chrome plated locking bolts offering smooth operation.
- Internal anchor bolt hole with hardware.
- U.L. listed Group II key changeable combination lock with relock. 1 million possible combinations.
- Auxiliary spring-loaded relock device activated by severe attack.
- Heavy duty steel hinges provide additional security and smooth operation.
- For your convenience, rubber feet are standard on models UL1511 – 1812XD.
- Heavy duty rolling casters on UL2018 and up.
- Attractively accented with a brass-plated dial, brown powder coated handle, decorative emblems and plush velour interior.
- Available in Granite textured finish.

BURGLARY & FIRE SAFES

The AMSEC BF™ Series offers a unique design that combines all the security features of a burglary safe and the peace of mind achieved with a fire safe. The industry's first U.L. 1-HOUR 350F listed, fire rated burglary safe offers an affordable solution when burglary and fire protection are an essential part of your buying decision!



BF1512



BF3416



BF1716

AS-BF1512

AS-BF1512-ESL10-KEYPAD

AS-BF1716

AS-BF2116

AS-BF3416

- 2-5/8" thick, consisting of 1/8" outer and inner steel plates creating a burglary resistant structure enclosing a unique proprietary fire resistant material.
- Three massive 1" diameter solid steel chrome-plated locking bolts.
- A full length dead bar locks deep into the body preventing door removal during a forced entry attempt.
- U.L. listed Group II lock with spring-loaded auxiliary relock device.
- 1/4" heavy duty carburized hardplate.
- Heavy duty steel hinges provide easy smooth door operation.
- One recessed anchor bolt hole and mounting hardware are provided to securely anchor safe.
- Attractively accented with a large chrome-plated dial, matching handle and a plush velour interior.
- Durable and attractive granite finish with an interior of smokey gray plush velour.

(INSIDE- H15" x W12" x D13")

(OUTSIDE- H20-1/4" x W17-1/4" x D18-3/4")

SAME AS ABOVE WITH ELECTRONIC KEYPAD

(INSIDE- H17" x W16-1/2" x D16")

(OUTSIDE- H22-1/4" x W21-3/4" x D21-3/4")

(INSIDE- H21" x W16-1/2" x D14-1/2")

(OUTSIDE- H26-1/4" x W21-3/4" x D20-1/4")

(INSIDE- H34" x W16-1/2" x D16")

(OUTSIDE- H39-1/4" x W21-3/4" x D21-3/4")

IN-GROUND ROUND FLOOR SAFES

STAR Floor safes are engineered with advanced security features. STAR Tube safes have been the standard for gas stations, fast food, small retail establishments and home owners for over 50 years. Low cost, combined with the various body styles and optional doors will fit almost any cash handling system. When properly installed in concrete, STAR Floor safes provide maximum fire and burglary protection. Now, with the water resistant dust cover, you get protection from water as well.



- Manipulation resistant, unitized U.L. Group II key changeable lock protected by a revolving carburized hardplate.
- Removable dial and drive/drill resistant spindle preventing damage from burglary attack and additional protection from hold-up.
- Door, 7-1/4" clear opening, is 1-3/4" solid steel.
- Door is securely locked by three bolts each requiring over 25,000 pounds to shear.
- Each locking bolt has its own hardened steel positive relocking bolt.
- Body — Heavy "B" rate construction.

AS-C3	ROUND BODY SAFE
AS-C5-BODY ONLY	BODY ONLY FOR C5 FLOOR SAFE
AS-C5	ROUND BODY SAFE
AS-C5S	ROUND BODY SAFE WITH SLOTTED DOOR
AS-C7	ROUND BODY SAFE
AS-C7S	ROUND BODY SAFE WITH SLOTTED DOOR
AS-M011802	ROUND DOOR FOR C SERIES FLOOR SAFE
AS-M011806	ROUND DOOR FOR C SERIES FLOOR SAFE **SLOT**
AS-M012700	REBUILD KIT FOR -C- STAR HEAD SAFE
AS-B002000	REMOVABLE DIAL ONLY FOR -C- SAFES
AS-B009500	(S&G) CHANGE KEY FOR C SAFES (6720-043-003)



Cut-away View of "C" Rate Lift-Out Door

IN-GROUND SUPER BRUTE SQUARE FLOOR SAFES



All BRUTE Series safes are designed to provide secure storage for documents, jewellery, precious metals and miscellaneous valuables at an economical price. When properly installed in a concrete floor, BRUTE Series safes provide excellent fire and burglary protection. BRUTE floor safes meet and exceed the requirements of the Insurance Offices Manual of Burglary Insurance.

		Inside	Outside
		H x W x D	H x W x D
AS-B1500	SQUARE FLOOR SAFE	11-7/8" x 13-1/4" x 8-3/4"	12-3/4" x 14-1/8" x 11-3/4"
AS-B2200	SQUARE FLOOR SAFE	11-7/8" x 13-1/4" x 14"	12-3/4" x 14-1/8" x 17"
AS-B2900	SQUARE FLOOR SAFE	11-7/8" x 13-1/4" x 18-1/4"	12-3/4" x 14-1/8" x 21-3/8"

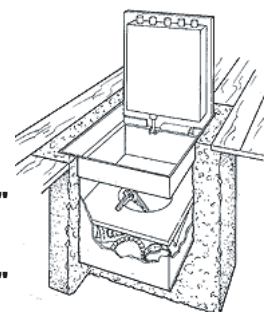

WALL SAFES

AMSEC Wall safes are designed to provide hidden protection for documents and miscellaneous valuables. Each wall safe is also designed for easy installation between 16 o/c wall studs with pre-drilled anchor holes and a built-in flange eliminating unnecessary replastering.



WS1014



WS1214

- U.L. listed Group II key changeable lock, with relock and 1 million possible combinations
- Electronic lock optional, or Chicago single key camlock with 2 keys.
- Flat dial allows flush mounted installation.
- WS1014: 3/16" thick solid steel door with dead bar.
- Continuous non-removable hinge.



WFS1310



WS1514



WES2113

- AS-WS1014 CONCEALED WALL SAFE (C/W FLANGE), 4" DEPTH
- AS-WS1214 HEAVY DUTY WALL SAFE C/W FLANGE, 10" DEPTH (B RATE)
- AS-WS1514 WALL SAFE C/W FLANGE, 4" DEPTH
- AS-WES2113 ELECTRONIC WALL SAFE
- AS-WFS1310 FIRE-WALL SAFE, INSIDE - H13" X W10" X D11"

IMPORTED FIRE SAFES



ES149

INSIDE DEMENSIONS - H x W x D
14-3/8" X 8-3/4" X 10"



ES1814

INSIDE DEMENSIONS - H x W x D
14" X 13" X 12-5/8"

BEST
VALUE



ES914

INSIDE DEMENSIONS - H x W x D
8-9/16" X 14-1/4" X 9-3/4"



FS149

INSIDE DEMENSIONS - H x W x D
14-3/4" X 8-3/4" X 10"

- AS-ES149 UL RATED 1-HOUR, ELECTRONIC KEYPAD
- AS-ES1814 UL RATED 1-HOUR, ELECTRONIC KEYPAD
- AS-ES914 UL RATED 1-HOUR, ELECTRONIC KEYPAD
- AS-FS149 UL RATED 1-HOUR, STANDARD DIAL
- AS-FS3018 UL RATED 1-HOUR, STANDARD DIAL
- AS-FS914 UL RATED 1-HOUR, STANDARD DIAL



FS3018

INSIDE DEMENSIONS - H x W x D
26-1/2" X 15-1/2" X 16-1/2"



FS914

INSIDE DEMENSIONS - H x W x D
8-9/16" X 14-1/4" X 9-3/4"

- AS-ESL-10XL-CHROME RETROFIT ELECTRONIC KEYPAD

RESIDENTIAL & HOTEL SAFES

AMSEC Wall safes are designed to provide hidden protection for documents and miscellaneous valuables. Each wall safe is also designed for easy installation between 16 o/c wall studs with pre-drilled anchor holes and a built-in flange eliminating unnecessary replastering.

AS-ES411



DRAWER SAFE

Quick-opening digital lock.
Heavy 16 gauge solid steel construction. Pry-resistant recessed 10 gauge door with internal hinges
Two tempered-steel live bolts.
Fits in a drawer and only requires 5" clearance. Key override system
Excellent for protecting valuables, hand guns or laptop computers.

Handgun Safe



Smith & Wesson®

AMSEC "5BE" electronic push button lock is fast and easy to use.
Replaces high cost mechanical lock alternatives with higher reliability.
Easy change combination with programmable override code for lost combinations.
9 VDC battery provides over 5000 openings with low battery indicator.
External auxiliary battery connection
Tamper proof penalty lockout protects against manipulation attempts.
LED status and beeper can be programmed on - off.
S&W deep blue finish with chrome hardware.
Interior cushioned with foam lining to protect gun from scratches.
Constructed of 16-ga. steel.
Strong, pry resistant custom brass locking bolt
Bolt holes provided to anchor safe

SWPB1 8" H x 12" W x 3" D 7.5 lbs.



AS-SWPB1

ASSA V-10 DEADBOLTS, CYLINDERS AND DEADBOLTS

ASSA's family of high security products can accommodate a wide variety of both institutional and residential applications. We offer a full line of cylinders designed to retrofit the leading lock manufacturers' locksets along with our own stand alone deadbolts, padlocks, and auxiliary locks. ASSA locks employ a patented dual locking mechanism that renders the lock virtually pick proof. This unique operation has allowed us to develop a patented key control system which protects against unauthorized duplication of keys and that can be master keyed into a security system to fit any customer's needs. All ASSA high security products are listed under U.L. 437, a set of tests used to determine a product's physical resistance against various forms of attack.

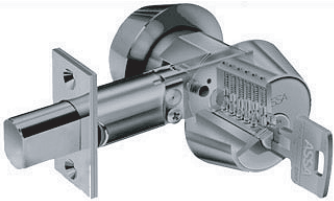

AV-V6000-SNS-605-3F-V10

SINGLE CYLINDER DEADBOLT, POLISHED BRASS

AV-V6000-SNS-626-3F-V10

SINGLE CYLINDER DEADBOLT, SATIN CHROME

AV-V6000DC-SNS-605-3F-V10

DOUBLE CYLINDER DEADBOLT, POLISHED BRASS

AV-V6000DC-SNS-626-3F-V10

DOUBLE CYLINDER DEADBOLT, SATIN CHROME

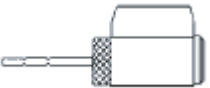

AV-65611-SNS-626-V10

CYLINDER FOR SCHLAGE A,B,D SERIES **KIK & KIL**



AV-65672-SNS-626-V10

CYLINDER FOR SARGENT 7,8,9 LINE **KIK**

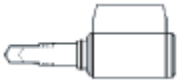

AV-65673-SNS-626-V10

CYLINDER FOR SARGENT 6 LINE **KIK**, 7 & 10 LINE **KIL**

MORTISE



AV-6551-1-SNS-626-V10
1 1/8" MORTISE CYLINDER
WITH ADAMS RITE CAM

RIM

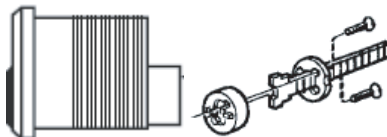

AV-6551-H-SNS-626-V10
1 1/8" RIM CYLINDER
WITH HORIZONTAL
TAILPIECE

#2 PADLOCK



AV-65611-SNS-V10
2 PADLOCK
(KEY RETAINING)

ASSA TWIN (AT) & TWIN EXCLUSIVE (AE) DEADBOLTS, CYLINDERS AND DEADBOLTS

ASSA's family of high security products can accommodate a wide variety of both institutional and residential applications. We offer a full line of cylinders designed to retrofit the leading lock manufacturers' locksets along with our own stand alone deadbolts, padlocks, and auxiliary locks. ASSA locks employ a patented dual locking mechanism that renders the lock virtually pick proof. This unique operation has allowed us to develop a patented key control system which protects against unauthorized duplication of keys and that can be master keyed into a security system to fit any customer's needs. All ASSA high security products are listed under U.L. 437, a set of tests used to determine a product's physical resistance against various forms of attack.

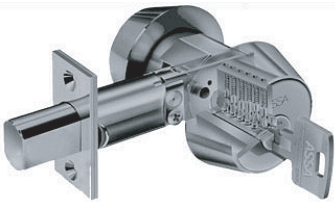

AT-6000-SNS-605-3F-6000

SINGLE CYLINDER DEADBOLT, POLISHED BRASS

AT-6000-SNS-626-3F-6000

SINGLE CYLINDER DEADBOLT, SATIN CHROME

AT-6000DC-SNS-605-3F-6000

DOUBLE CYLINDER DEADBOLT, POLISHED BRASS

AT-6000DC-SNS-626-3F-6000

DOUBLE CYLINDER DEADBOLT, SATIN CHROME

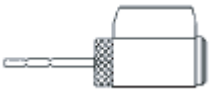

AT-65611-SNS-626-6000

CYLINDER FOR SCHLAGE A,B,D SERIES **KIK & KIL**

AE-E65611-SNS-626-TWINEX

CYLINDER FOR SCHLAGE A,B,D SERIES **KIK & KIL**



AT-65672-SNS-626-6000

CYLINDER FOR SARGENT 7,8,9 LINE **KIK**

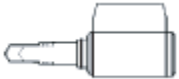

AT-65673-SNS-626-6000

CYLINDER FOR SARGENT 6 LINE **KIK**, 7 & 10 LINE **KIL**

1 1/8" MORTISE CYLINDERS



AT-6551-1-SNS-626-6000

WITH ADAMS RITE CAM

AE-E6551-6-SNS-626-TWINEX

SCHLAGE -L- CAM

RIM CYLINDERS

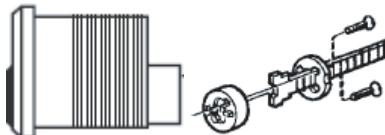

AT-6551-H-SNS-626-6000

AE-E6551-H-SNS-626-TWINEX

1 1/8" RIM CYLINDER

WITH HORIZONTAL TAILPIECE

#2 PADLOCK



AT-65191B-SNS-6000

2 PADLOCK

(KEY RETAINING)



AT-7680-SNS-626-6000

UTILITY LOCK



AT-70600IC-SNS-626-6000

INTERCHANGEABLE CORE



AT-PK-4-MINI
AT-PK-1

PIN KIT

MINI PIN KIT FOR V-10 AND TWIN-6000
FULL SIZE PIN KIT V-10 & TWIN-6000



SPRINGS & SIDE PINS

AT-867015	TWIN-6000 SIDE PINS (50/PKG)
AT-867065	CYLINDER SPRINGS (100/PKG)
AT-867087	TWIN-6000 SIDE PIN SPRINGS (100/PKG)
AT-867088	TWIN-6000 SIDE BAR SPRINGS (100/PKG)
AV-267008-A77	V-10 SIDEBAR (#A77)
AV-353838	V-10 LEFT HAND SIDE PIN (50/PKGE)
AV-807164	V-10 SIDE BAR SPRING (100/PKGE)
AV-807165	V-10 SIDE PIN SPRING (100/PKGE)

PINS

DRIVERS

AT-867066	#1-2
AT-867067	#3-4
AT-867068	#5-6
AT-867069	#7-8-9

MASTER

AT-867070	#1
AT-867071	#2
AT-867072	#3
AT-867073	#4
AT-867074	#5
AT-867075	#6
AT-867076	#7
AT-867077	#8

BOTTOM

AT-867078	#1
AT-867079	#2
AT-867080	#3
AT-867081	#4
AT-867082	#5
AT-867083	#6
AT-867084	#7
AT-867085	#8
AT-867086	#9

PARTS

AT-867090	ASSA PHILLIPS SCREW FOR MORTISE CAMS
AT-867445	ASSA CAM FOR MORTISE CYLINDER - ADAMS RITE
AT-867446	ASSA CAM FOR MORTISE CYLINDER - CORBIN CLOVER LEAF
AT-867447	ASSA CAM FOR MORTISE CYL. - CORBIN BEAVER TAIL
AT-867450	ASSA HORIZONTAL & VERTICAL RIM TAILPIECE KIT
AT-867452	ASSA CAM FOR MORTISE CYLINDER - SARGENT
AT-867453	ASSA CAM FOR MORTISE CYLINDER - SCHLAGE -L- SERIES
AT-907003-626	ASSA FACEPLATE BOLT ONLY FOR 6000 (2-3/8 BACKSET)
AT-868138	SLOTTED SCREWS FOR RIM TAILPIECE
AT-868141	PIN CHAMBER CLOSING STRIPS (100/PKGE)
AT-872610	CAM FOR MORTISE CYLINDER - YALE STANDARD CAM

PERMA-VAULT

SLOTTED DROP BOX



- Patented interchangeable slide off tops can be rotated from vault to vault for additional security at no extra cost.
- Anti-fish baffle deters removal of contents
- Cash slots for easy insertion of cash and checks without unlocking
- No mechanical, electrical or hinged components to wear down or break out.
- Heavy gauge steel construction
- Unique design permits bolting and mounting to any structurally sound surface.
- UL Listed MEDECO® Locking System
- Keys removable only in locked position

**BF-PRO-30**

FRONT LOAD DROP BOX

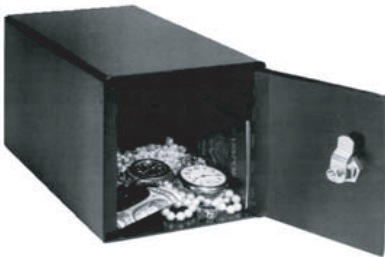

- Heavy gauge steel construction.
- Finished with 2 coats of black, oven baked enamel.
- Pre-drilled holes permits bolting and mounting to any structurally sound surface.
- Keys removed only in the locked position.
- Easy Access to Remove Contents

**BF-PRO-20**

IN-ROOM SAFE DEPOSIT BOX



- Patented interchangeable slide-off tops can be rotated from vault to vault for additional security at no extra cost
- Heavy gauge steel construction, black powder coat finish
- No mechanical, electrical, or hinged components to wear out or break down
- Unique design permits bolting and mounting to any structurally sound surface

BF-PV100-M

CV-600 MPROX SINGLE DOOR PROXIMITY READER

MPROX consists of two parts; a vandal and weather resistant mullion mount proximity reader and a small programmer/controller which is installed on the secure side of the facility. The system has a capacity of 999 users. Cards and fobs can be individually or batch enrolled/deleted. All programming is done through the controller and reader - there is no need for computers or software to enroll or delete cardholders.

- Up to 999 users
- Jamb mount proximity reader
- 12/24V AC/DC operation
- Up to 200 feet (70 metres) between reader and controller
- Request to exit input (N/O)
- Form C relay - 5 amps
- Bi-color LED and sounder
- Door open time: 1-180 seconds or latching
- Presence input (parking, man-trap applications)



PROX CARDS & FOBs
NOT INCLUDED

CD-CV-600
CD-CV-CSH
CD-CV-KTH

MPROX CONTROLLER WITH MULLION PROX READER
CAMDEN PROX CARD FOR CV-600 (20 per pack)
CAMDEN PROX KEY FOB FOR CV-600 (10 per tube)

CD-CV-600

KEY SWITCHES



CM-1000 switch boxes are heavy duty key switches designed for outdoor use. Supplied with a sealed cast aluminum surface mount box, with a 1/2" threaded conduit opening for pipe or pedestal mounting. Includes choice of switch, cylinder lock ring, rubber gasket, and tamperproof screws. For use with standard 1" - 1 1/4" mortise cylinders (sold separately) Optional LED's.

CD-CM-1000 SURFACE MOUNT KEY SWITCH, SPST MOMENTARY
CD-CM-1000/40 MOMENTARY CONTACT SPDT SWITCH ONLY
CD-CM-1000/45 MAINTAINED CONTACT SPDT SWITCH ONLY



CM-1100 mortise style key switches fit standard single gang in-wall boxes, or may be surface mounted. Heavy duty diecast aluminum construction. Various switch configurations available. Optional LED'S. Standard brushed aluminum finish. Mortise cylinder sold separately.

CD-CM-1120 SPDT MOMENTARY SINGLE GANG SWITCH
CD-CM-1130 SPDT MAINTAINED SINGLE GANG SWITCH



CM-2000 Series - Narrow Key Switch

These heavy duty cast aluminum key switches are only 1 3/4" wide, and are perfect for mounting in door jambs, or other space-restricted areas. For use with standard 1" - 1 1/4" mortise cylinders (sold separately). Optional LED's. Choice of switch configurations.

CD-CM-2020 SPDT MOMENTARY KEY SWITCH, BRUSHED ALUMINUM FINISH

ALL-ACTIVE SWITCHES



CM-25 Series - All-Active Narrow Switch

Narrow push switches easily mount in door jambs, or may be surface mounted using our CM-23/23D jamb boxes. Heavy-duty stainless steel construction. Ultra-quiet operation. ADA compliant. Optional weatherproofing options and decorative finishes.

CD-CM-25/4	HANDICAP/PUSH TO OPEN SWITCH - BLUE (SPST)
CD-CM-25/2	HANDICAP LOGO - BLUE
CD-CM-23	SURFACE MOUNT JAMB FOR CM-25 SERIES

CM45 Series - All-Active - 4 1/2 Inch Square

All-Active Switches require minimal actuation force and meet ADA standards. Constructed from stainless steel or solid brass, with a choice of faceplate designs and finishes. All models feature Camden's exclusive buffed finish, durable 4 stud switch mount design, rubber dampers for smoother actuation and quiet operation. Use model CM-43CBL for surface mount applications.



CD-CM-45/2	HANDICAP LOGO-BLUE
CD-CM-45/3	PUSH TO OPEN - BLACK
CD-CM-45/4	HANDICAP/PTO - BLUE
CD-CM-45/5	FRENCH PRINT - HANDICAP / PUSSEZ POUR OUVRIR
CD-CM-43CBL	SURFACE MOUNT BOX FOR CM-45 SERIES

REQUEST-TO-EXIT BUTTONS



CM-30E Series are high visibility illuminated buttons which can be supplied with either standard incandescent bulbs or super bright, ultra-long life LED's. Large 2" square buttons, with PUSH TO EXIT logo. 12V/24V

CD-CM-30E	ENGLISH PRINT - PUSH TO EXIT, GREEN
CD-CM-30F	FRENCH PRINT - Poussez Pour Sortir, GREEN



CM-400 Series - Single Gang Stainless Steel (ADA)

Rugged, attractive request-to-exit buttons which are easy to activate. Free-spinning 1 5/8" red mushroom button (green or blue also available). DPST N/O and N/C contacts.

CD-CM-420E	SINGLE GANG STAINLESS STEEL FACEPLATE, RED MUSHROOM, EXIT ENGRAVED ON BUTTON
------------	--



CM-250 Series - Narrow Economy Switches

For mounting in door jambs, or other space-restricted areas. Stainless steel faceplate. 1" red SPDT momentary button.

CD-CM-250/4	HANDICAP LOGO/PUSH TO OPEN
CD-CM-250/6	PUSH TO OPEN
CD-CM-250/9	FRENCH PRINT - PUSSEZ POUR SORTIR

ACTIVE SWITCHES



CM-40 Series - All-Active - 4 1/2 Inch Round

All-Active Switches require minimal actuation force and meet ADA standards. Constructed from stainless steel or solid brass, with a choice of faceplate designs and finishes. All models feature Camden's exclusive buffed finish, durable 4 stud switch mount design, rubber dampers for smoother actuation and quiet operation.

CD-CM-40/4 HANDICAP/PUSH TO OPEN - BLUE



CM-49

Vandal and weather resistant low profile escutcheon. The "spaceship" is designed for surface or flush mounting 4 1/2" round switches (CM-40 series). Patented 2-piece ABS construction ideal for use with RF controls

CD-CM-49 40 SERIES VANDAL/WEATHER RESISTANT PROTECTOR



CM-60 Series - All-Active - 6 Inch Round

All-Active Switches require minimal actuation force and meet ADA standards. Constructed from stainless steel or solid brass, with a choice of faceplate designs and finishes. All models feature Camden's exclusive buffed finish, durable 4 stud switch mount design, rubber dampers for smoother actuation and quiet operation.

CD-CM-60/4 HANDICAP/PUSH TO OPEN - BLUE



CM-800 Series - Rocker Switches

Hard-wire remote door release switches may be easily mounted under desks/counters, or on walls. Available in either NEMA aluminum box or shallow black plastic enclosures. Great for activating/de-activating mag locks or electric strikes. Momentary and maintained models. switch mount design, rubber dampers for smoother actuation and quiet operation.

CD-CM-810 NEMA BOX SPDT MOMENTARY

VANDAL RESISTANT SWITCHES



CM-9000 Series switches are all-steel construction set in a 1/4 inch thick aluminum faceplate. These super tough, low profile switches can withstand attack of all types, even direct hammer blows.

CD-CM-9180	DPDT MOMENTARY, NARROW FACEPLATE
CD-CM-9190	DPDT MAINTAINED, NARROW FACEPLATE
CD-CM-9080	DPDT MOMENTARY, SINGLE GANG FACEPLATE
CD-CM-9090	DPDT MAINTAINED, SINGLE GANG FACEPLATE



CM-9600 - Lighted Piezo Exit Buttons

Camden CM-9600 series is a vandal resistant, illuminated exit switch incorporating a 40 second timer. The heavy duty stainless steel faceplate is designed to mount, depending on the model, into a single gang or narrow jamb electrical box.

CD-CM-9600/1	BLANK FACE PLATE
CD-CM-9600/7	PUSH TO EXIT



CM-9700 - Piezo Exit Switch

Camden Heavy-Duty CM-9700 series is a one piece all aluminum construction with a non-moving Piezo actuator. Fully weather and vandal resistant. Poussez pour sortir label also included. Lifetime warranty.

CD-CM-9700	SINGLE GANG, N/O, WITH GREEN PUSH TO EXIT
CD-CM-9710	JAMB (NARROW), N/O, WITH GREEN PUSH TO EXIT



CM-9280 - Single Gang Piezo Pushbutton

CM-9380 - Narrow Piezo Push Buttons

Piezo Push Switches incorporate a patented, non-moving, one piece design which is virtually impervious to attack or compromise. Tested to 50 million cycles for use under extreme conditions, these sealed aluminum switches carry a Lifetime Warranty.

CD-CM-9280R	1" DIAMETER, MOMENTARY N/O, RED BUTTON, SINGLE GANG
CD-CM-9280G	1" DIAMETER, MOMENTARY N/O, GREEN BUTTON, SINGLE GANG
CD-CM-9380R	1" DIAMETER, MOMENTARY N/O, RED BUTTON, NARROW FACEPLATE
CD-CM-9380G	1" DIAMETER, MOMENTARY N/O, GREEN BUTTON, NARROW FACEPLATE



KEYPADS

These light/medium duty models are primarily designed for interior traffic control applications, or for controlling access to equipment or machinery. CM-120IS/OS models fit into single gang, in-wall boxes.

CD-CM-120OS 120 USER KEYPAD, OUTSIDE USE, 12/24V AC/DC, NON-ILLUMINATED
CD-CM-120IS 120 USER KEYPAD, INSIDE USE, 12/24V AC/DC, NON-ILLUMINATED

MAGNETIC LOCKS



Variety of models for single or double doors. 1200 lb holding force for exterior (perimeter) doors. 600 lb holding force for interior traffic control. 300 lb micro-mags for cabinets, gun lockers, or other restricted space applications. Wide range of mounting brackets available. 12/24V DC operation. TDS models include adjustable timer, lock status sensor (bond sensor), door position switch, relay and LED.

CD-CX-91S-06-TDS SURFACE MOUNT SINGLE DOOR 600 LBS MAGNETIC LOCK
CD-CX-91S-12-TDS SURFACE MOUNT SINGLE DOOR 1200LBS MAGNETIC LOCK

DOOR INTERFACE RELAY

CX-11 Ultra Switching Network

The CX-11 Ultra is an economical door-interface relay. Used as a make/break relay (or Switching Network) it eliminates the binding of locked automatic doors, by delaying the door operator until the strike or electromagnet (de) activates first. The CX-11 Ultra can also be used to sequence two vestibule doors. May be set for momentary, maintained, or latching modes. 12/24V AC/DC.



CD-CX-11ULTRA DOOR INTERFACE RELAY

DOOR SEQUENCER

CX-21 Bi-Directional Door Sequencer

Compact and user friendly, this relay is designed to sequence two automatic doors in both directions. Applications include libraries, hospitals, restaurants, hotels, etc. 12/24V AC/DC operation.



CD-CX-21 DOOR SEQUENCER

REQUEST-TO-EXIT SENSOR



CM-419 - Request-to-Exit Sensor

Request-to-exit sensor for use with mag locks and electric strikes, to shunt out the alarm/access system. Adjustable for single or double doors. Two relays. White or silver color.

- Passive infra-red sensor
- Dual pyros for increased stability
- Ceiling, wall or frame mount
- Adjustable coverage for single and double doors
- Adjustable .25-60 second timer
- 12-24 V AC/DC
- Two form C relay outputs for activating cameras, remote devices, door shunting or to de-activate mag lock in case of system failure
- Fail-safe or fail-secure operation
- U/L listed

CD-CM-419S
CD-CM-419W

REQUEST-TO-EXIT SENSOR - SILVER FINISH
REQUEST-TO-EXIT SENSOR - WHITE FINISH

BLUE PULL STATIONS



CM-700 Series - Blue Pull Stations

Blue pull stations are used on emergency doors for releasing mag locks. Sturdy aluminum construction with choice of wording and language. Optional lift cover.

- | | |
|-------------|--|
| CD-CM-701 | 1xN/C PULL FOR DOOR RELEASE |
| CD-CM-701E | 1xN/C PULL IN CASE OF EMERGENCY |
| CD-CM-701BE | 1xN/C, AS ABOVE ENGLISH/FRENCH |
| CD-CM-702 | 2 x N/C PULL FOR DOOR RELEASE |
| CD-CM-702E | 2 x N/C PULL IN CASE OF EMERGENCY |
| CD-CM-702BE | 2 x N/C AS ABOVE ENGLISH/FRENCH |
| CD-CM-703 | 1 xN/C + 1 x N/O PULL FOR DOOR RELEASE |
| CD-CM-703E | 1 xN/C + 1 x N/O PULL IN CASE OF EMERGENCY |
| CD-CM-703BE | 1 xN/C + 1 x N/O AS ABOVE ENGLISH/FRENCH |
| CD-CM-xxxPC | CLEAR LIFT COVER FOR ABOVE MODELS |



POWER TRANSFER CABLES

- CD-CM-PTSS-18 Stainless steel cable and endcaps, 18 inches, 1/4" ID
 CD-CM-PTSS-12 Stainless steel cable and endcaps, 12 inches, 1/4" ID
 CD-CM-PT516M Concealed Power Transfer Cable, 5/16 inch inside diameter, mortise mount

7 DAY TIMERS

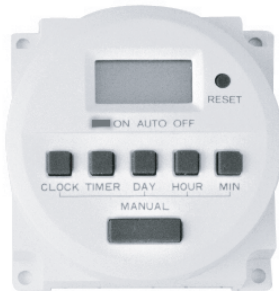

CX-247 7 Day Timer

With 8 flexible daily or weekly (on/off) schedules the CX-247 can automatically activate/deactivate electric locks and magnets, automatic doors; or control lighting or energy management devices. Very compact, and easy to program and install.

- CD-CX-247-12 7 DAY TIMER - 12V
 CD-CX-247-24 7 DAY TIMER - 24V

REPLACEMENT PARTS

- CD-LS-11 MORTISE CYLINDER LOCKING NUT
 CD-CM-1000/50 SPST-NORMALLY OPEN MOMENTARY SWITCH FOR FAIL-SECURE ELECTRIC STRIKES
 CD-CM-1000/32 SPST-NORMALLY CLOSED SWITCH FOR MAG LOCK
 CD-CM-1000/35 SPST ON/OFF SWITCH (OLD #LS-3MS)
 CD-CM-1000/40 SPDT MOMENTARY CONTACT SWITCH (N/O-N/C)
 CD-CM-1000/45 SPDT MAINTAINED CONTACT SWITCH
 CD-CM-1000/82 INSERT BIT FOR TORX TAMPER PROOF SCREWS

DRAWER LOCKS

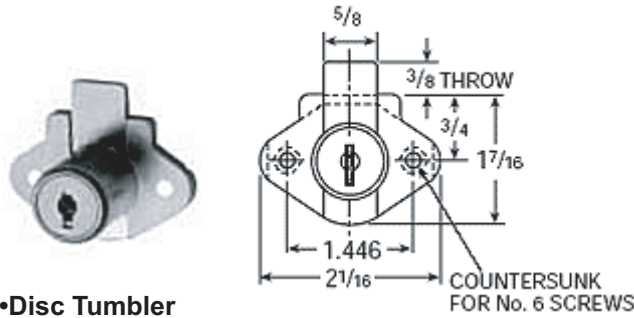

- Disc Tumbler
- Can be masterkeyed
- Material: Brass plated steel backplate and bolt, pressure cast cylinder

CC-02066-78-26D KEYED DIFFERENT
CC-02066-78-26D-KA-AUE30 KEYED ALIKE AUE30
CC-02066-78-26D-KA-AUE48 KEYED ALIKE AUE48
CC-02066-78-26D-KA-AUE75 KEYED ALIKE - AUE75

PADLOCKS

- 10,000 possible combinations
- Heel and toe locking.
- All Brass internal locking mechanism. Automatic "0000" stop. Full instructions furnished with each lock. Available carded from stock.
- The combination is quickly and easily set and can be changed any time by the owner.
- Material: Brass



CC-K436 CCL SESAME PADLOCK

CCL LOCKABLE PANEL LOCK

- Disc Tumbler
- Can be masterkeyed
- Material: Pressure Cast Lift Lever & Bolt, Steel Case, Zinc Plated Standard



LEFT HAND SHOWN

CC-15767-LH-KA-AUE-101 LEFT HAND, LATCH ON RIGHT
CC-15767-RH-KA-AUE-101 RIGHT HAND, LATCH ON LEFT



SM-1007-28 7" ALUMINUM
 SM-1007-32D 7" STAINLESS STEEL
 SM-1009-28 9" ALUMINUM
 SM-1009-32D 9" STAINLESS STEEL



9" PULL X 41X16" BACKPLATE
 SM-1709-28 ALUMINUM
 SM-1709-32D STAINLESS STEEL



DOME DOOR STOP
 SM-200-26D LOW TYPE
 SM-218-26D HIGH TYPE



HOLLOW WALL STOP
 SM-233-26D

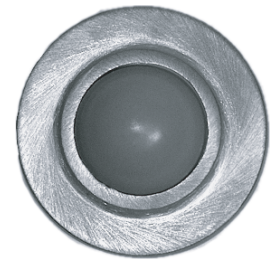

DOME WALL STOP
 SM-231-26D



KICK PLATES
 SM-80A-28-8X30 ALUMINUM
 SM-80A-28-8X34 ALUMINUM
 SM-80A-32D-8X30 STAINLESS STEEL
 SM-80A-32D-8X34 STAINLESS STEEL
 SM-80A-C3-6X30 POLISHED BRASS
 SM-80A-C3-6X34 POLISHED BRASS



ALUMINUM FINGER PULL
 SM-980-26D



PUSH PLATES
 SM-81A-28-4X16 ALUMINUM
 SM-81A-32D-4X16 STAINLESS STEEL
 SM-81A-C3-4X16 POLISHED BRASS

PATIO DOOR SECURITY

CHARLEY BARS are for inside, outside or double sliding panels Fits 36" to 48" sliding glass doors. Cadmium plated steel hinge bracket Durable plastic end bracket. Made of rust-proof sturdy aluminum square tubing with a durable plastic end cap and bracket

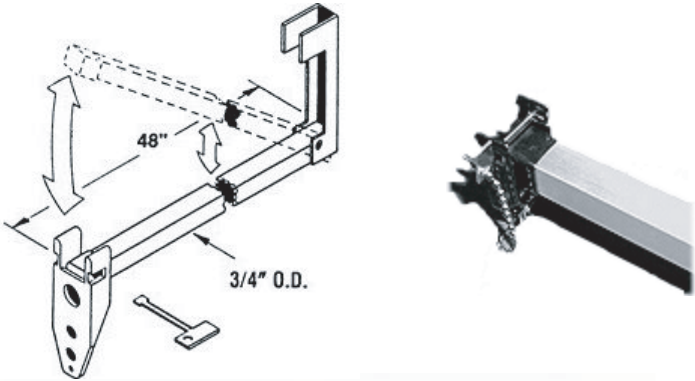

- | | | |
|--------------|--------------------------|-------------------|
| CB-A48-CARD | CHARLEY-BAR 48" ALUMINUM | (DISPLAY CARD) |
| CB-A48-TUBE | CHARLEY-BAR 48" ALUMINUM | (INDIVIDUAL TUBE) |
| CB-BR48-CARD | CHARLEY-BAR 48" BRONZE | (DISPLAY CARD) |
| CB-BR48-TUBE | CHARLEY-BAR 48" BRONZE | (INDIVIDUAL TUBE) |
| CB-W48-CARD | CHARLEY-BAR 48" WHITE | (DISPLAY CARD) |
| CB-W48-TUBE | CHARLEY-BAR 48" WHITE | (INDIVIDUAL TUBE) |

FILING CABINET LOCKS

- Four pin tumbler plug.
- Die cast barrel with die cast bolt.
- No. 5002LP has rectangular bolt.

- Other models have round bolt.
- Standard finish — Satin Chrome.
- Two keys furnished per lock.

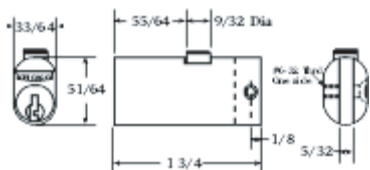
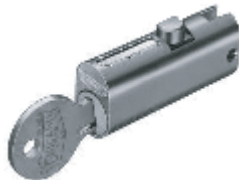
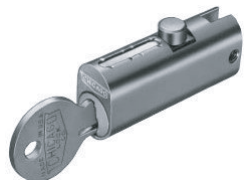

5001LP

ROUND BOLT
CH-5001-50KD
 EXTRA DEEP SLOT
CH-5001LP-KD

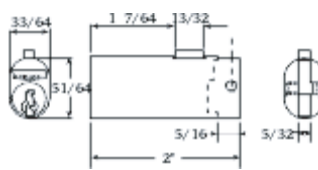

5002LP

SQUARE BOLT
CH-5002LP-KD
CH-5002LP-KA-3X5

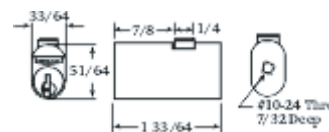

EXP-19DC

SQUARE BOLT
CH-EXP-19DC-KD
CH-EXP-19DC-KA-5X75

SWITCH LOCKS

Double Bitted Assembly With Eleven Criss-Cross Blade Tumblers.

- Lock operation same as 4073 Series.
- Contact configuration: SPST
- 7 amps (resistive) @ 125 Volts A.C.
7 amps @ 28 Volts d.C.
- Electrical Life: 6,000 cycles @ Max. Load.
- Contact resistance: 50 milli ohms initial maximum.
- Standard Finish — Bright Chrome.
- Two keys furnished per lock.
- Master - keying not available.

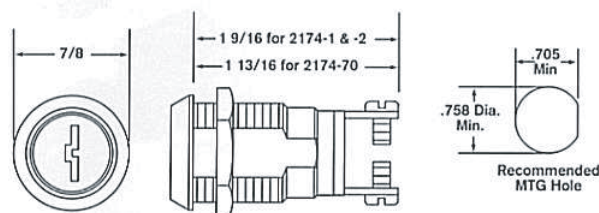

CH-2174-1DC-KA-2007
CH-2174-2DC-KD
CH-2174-70DC-KA-2007

ON-OFF KEY REMOVABLE OFF POSITION
ON-OFF KEY REMOVABLE ON & OFF POSITION
MOMENTARY CONTACT (SPRING LOADED)



RECESSED

Quality - Model S-101 vertical mailbox has a level of quality and durability that is unequalled in our industry.

100%
CANADIAN
MADE

CM-S101R-3-GANG-ALUM
CM-S101R-4-GANG-ALUM
CM-S101R-5-GANG-ALUM
CM-S101R-6-GANG-ALUM

RECESSED ALUMINUM MAILBOX, 3 GANG
RECESSED ALUMINUM MAILBOX, 4 GANG
RECESSED ALUMINUM MAILBOX, 5 GANG
RECESSED ALUMINUM MAILBOX, 6 GANG



Security - Constructed with heavy gauge reinforced extruded aluminum to give a lifetime of service and maximum protection for the mail.



SEMI-RECESSED

NOTE: THIS COLLAR IS TO BE COMBINED WITH A RECESSED MAILBOX TO GET SEMI-RECESSED

CM-125SR3-ALUM
CM-125SR4-ALUM
CM-125SR5-ALUM
CM-125SR6-ALUM

SEMI-RECESSED COLLAR FOR 3 GANG
SEMI-RECESSED COLLAR FOR 4 GANG
SEMI-RECESSED COLLAR FOR 5 GANG
SEMI-RECESSED COLLAR FOR 6 GANG

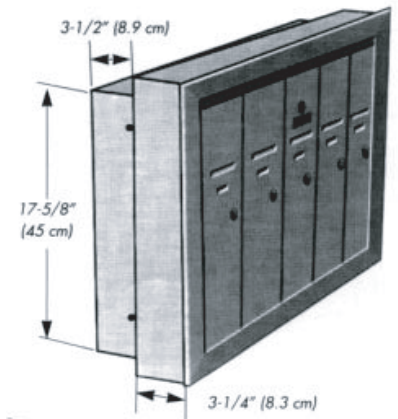

Performance - The trim and doors have striated vertical lines to resist scratching and marring. All exposed materials are of a fine quality aluminum; smooth interior surfaces are maintenance free

100%
CANADIAN
MADE



SURFACE MOUNT

Installation - The excellence of design allows the mailboxes to be installed easily and quickly.

NOTE: THIS COLLAR IS TO BE COMBINED WITH A RECESSED MAILBOX TO GET SURFACE MOUNT

CM-125SM3-ALUM
CM-125SM4-ALUM
CM-125SM5-ALUM
CM-125SM6-ALUM

SURFACE MOUNT COLLAR FOR 3 GANG
SURFACE MOUNT COLLAR FOR 4 GANG
SURFACE MOUNT COLLAR FOR 5 GANG
SURFACE MOUNT COLLAR FOR 6 GANG



Locks - All compartment doors come equipped with 5-pin cylinder C.P. approved locks with 2 keys, 1,000 changes.

MAIL CARRIER KEY KEEPER

Allows mail carriers access to building where buildings are not equipped with self-closing, automatically locking street entrance doors.



CM-172-SM-LK-ALUMINUM
SURFACE MOUNTED KEY KEEPER

MORTISE CYLINDERS

1000 Series Mortise Cylinders by Corbin Russwin are Standard with A01 Cloverleaf Cam. Cylinders Come Keyed Random (Keyed Different).

- CO-1000-118-A02-6-60-626 1-1/8" MORTISE CYLINDER (60 KEYWAY) (SATIN CHROME)
- CO-1000-118-A02-6-67-626 1-1/8" MORTISE CYLINDER (67 KEYWAY) (SATIN CHROME)
- CO-1000-118-A02-6-77-626 1-1/8" MORTISE CYLINDER (77 KEYWAY) (SATIN CHROME)
- CO-1000-118-A02-6-L4-626 1-1/8" MORTISE CYLINDER (L4 KEYWAY) (SATIN CHROME)
- CO-1000-114-A02-6-77-606 1-1/8" MORTISE CYLINDER (77 KEYWAY) (SATIN BRASS)



RIM CYLINDERS

3000-200 is Corbin Russwin's Standard Rim Cylinder with a 2" Tailpiece.

- CO-3000-200-6-60-626 RIM CYLINDER (60 KEYWAY)
- CO-3000-200-6-77-626 RIM CYLINDER (77 KEYWAY)
- CO-3000-200-6-L4-626 RIM CYLINDER (L4 KEYWAY)



KEY-IN-KNOB CYLINDERS

2000 Key-In-Lever Cylinder for CL3300 Extra Heavy Duty Levers or CL3600 Heavy Duty Levers.

- CO-2000-044-60-6-619 K.I.K. CYLINDER FOR CK4400 (60 KEYWAY)
- CO-2000-044-L4-619 K.I.K. CYLINDER FOR CK4400 (L4 KEYWAY)
- CO-2000-052-626-60-6 K.I.K. CYLINDER FOR CK4200 (60 KEYWAY)
- CO-2000-052-626-77-6 K.I.K. CYLINDER FOR CK4200 (77 KEYWAY)
- CO-2000-052-626-L4-6 K.I.K. CYLINDER FOR CK4200 (L4 KEYWAY)



INTERCHANGEABLE CORE (I/C) CYLINDERS

8000 IC Core is 6-Pin Standard. The 8000 IC Core Cylinder is available in three (3) Corbin Russwin Keyways in a satin chrome finish. Russwin IC Cores come 0-Bitted and with a control key.

- CO-8000-6-60-626 I/C CYLINDER (60 KEYWAY)
- CO-8000-6-77-626 I/C CYLINDER (77 KEYWAY)
- CO-8000-6-L4-626 I/C CYLINDER (L4 KEYWAY)



ORIGINAL KEYBLANKS (SOLD IN MULTIPLES OF 50)

- CO-KBB-59D1-6PIN-10 CO-KBB-N3-6PIN-12
- CO-KBB-N1-6PIN-12 CO-KBB-N4-6PIN-12
- CO-KBB-N10-6PIN-12 CO-KBB-N6-6PIN-12
- CO-KBB-N11-6PIN-12 CO-KBB-N7-6PIN-12
- CO-KBB-N12-6PIN-12 CO-KBB-N9-6PIN-12
- CO-KBB-N2-6PIN-12

CL4200 SERIES GRADE 1 KNOB LOCKSETS

For use in Commercial & Industrial applications including Schools, Hospitals and Apartments

CO-CK4251-GRC-613-6-60
CO-CK4251-GRC-630-L/C
CO-CK4255-GRC-630-77-6
CO-CK4255-GRC-630-L/C
CO-CK4257-GRC-630-L/C

ENTRANCE LOCKSET (OIL RUBBED BRONZE)
ENTRANCE LOCKSET (LESS CYLINDER)
CLASSROOM LOCKSET (77 KEYWAY)
CLASSROOM LOCKSET (LESS CYLINDER)
STOREROOM LOCKSET (LESS CYLINDER)



CK4400 SERIES GRADE 2 KNOB LOCKSETS

Recommended for use in Commercial applications including offices, motels and apartments

CO-CK4451-GWC-630-6-L4

ENTRANCE LOCKSET (L4 KEYWAY)



CL3300 SERIES GRADE 1 LEVER LOCKSETS

For use in Commercial & Industrial applications including Schools, Hospitals and Apartments

CO-CL3351-NZD-626-L/C

EXTRA HEAVY DUTY ENTRANCE
LOCKSET (LESS CYL)



PANIC DEVICES

For use in Commercial & Industrial applications including Schools, Hospitals and Arena's

Corbin Russwins ED8000 Series Pushbar Exit Devices is a panic rim device that features heavy duty steel construction and Grade 1 performance, while priced for outstanding value. Handing: Nonhanded (reversible). Door Thickness: 1-3/4. Backset: 2-3/4. Bar Length: Standard 36 bar fits 31 36 door. Optional 30 bar fits 28 30 door. Optional 42 bar fits 37 42 door. Projection: 2-1/2. Trim: Cylinder is not included. Stile: Minimum Width 5".

CO-ED8200-689-36 CORBIN PANIC DEVICE



ML2000 SERIES MORTISE LOCKSETS

The ML2000 series is a Grade 1 mortise lock designed to meet the rigors of high-traffic commercial, institutional, industrial and government applications. Constructed of heavy-gage steel, the lockbody features our patented Quick Reversible latchbolt, and a 1" stainless steel deadbolt. A wide variety of trim designs and functions and a 10-year warranty lend to the ML2000's versatility and reliability.

Key Advantages

- Patented Quick Reversible feature enables reversal of hands without disassembling the lock case (Patent # 6,349,982)
- Security trims provide a vandal-resistant barrier
- Can be used with new or existing Corbin Russwin key systems, including patented high-security Pyramid cylinders. (Patent # 6,125,674) Also accepts cylinders of most other manufacturers.
- Provides life safety and security in a single door prep, saving the additional cost of a deadlock
- Through-bolted trim designs for proper alignment and increased security

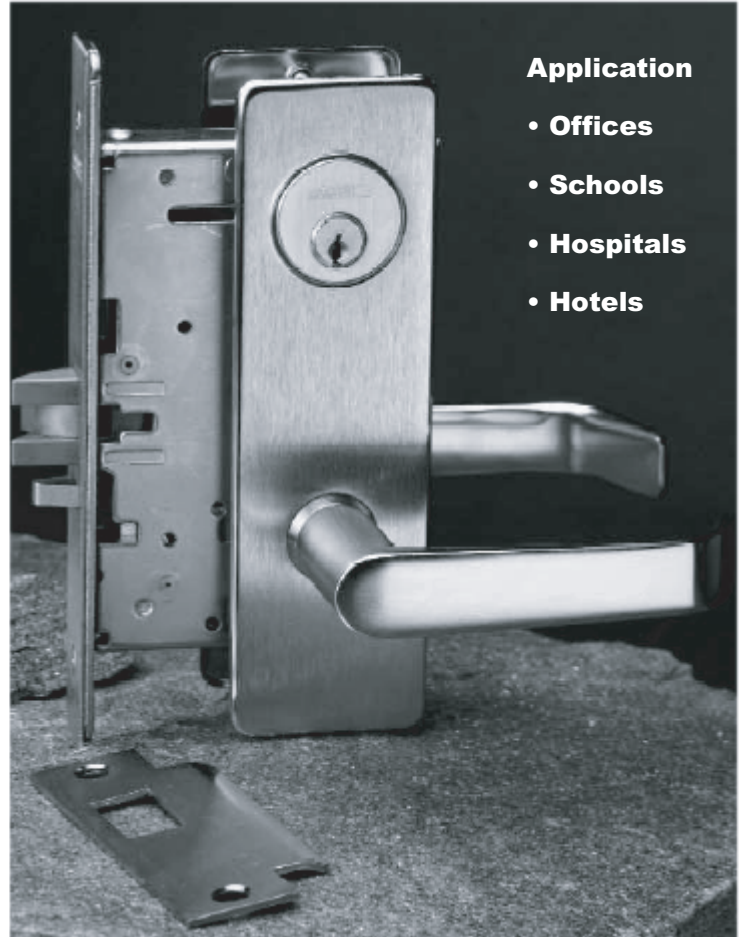

Application

- Offices
- Schools
- Hospitals
- Hotels

Aesthetics

Complement any application with the full range of trim designs and finishes offered with ML2000 Series. From stainless steel security trims to bright brass Vineyard levers, design continuum can be achieved without forfeiting aesthetics. For additional information regarding designer trim

- CO-ML2010-NSA-630
- CO-ML2051-GRC-630-L/C
- CO-ML2051-LWA-630-6-L4
- CO-ML2051-NSA-630-L/C
- CO-ML2055-GRC-630-L/C
- CO-ML2055-LWA-630-6-L4
- CO-ML2055-NSA-630-L/C
- CO-ML2057-LWA-630-6-L4
- CO-ML2057-NSA-630-L/C

- LEVER PASSAGE MORTISE SET
- OFFICE MORTISE LOCKSET (LESS CYLINDER)
- OFFICE MORTISE LOCKSET
- OFFICE MORTISE LOCKSET (LESS CYLINDER)
- CLASSROOM MORTISE LOCKSET (LESS CYLINDER)
- CLASSROOM MORTISE LOCKSET
- CLASSROOM MORTISE LOCKSET (LESS CYLINDER)
- STOREROOM MORTISE LOCKSET
- STOREROOM MORTISE LOCKSET (LESS CYLINDER)





ECL-230D Short Bar
(Cylinder and bar guard sold separately)

EXIT CONTROL LOCK

The ECL-230 is a code compliant, battery alarmed, rugged dead bolt, panic device with steel plate and photo-luminescent sign providing managed security and a 100 decibel alarm for secondary exits.

DX-ECL-230D-KEY#11CU
DX-ECL-1576-15

**CAM BRIDGE
ASSEMBLY KIT**

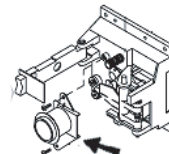

PANIC EXIT ALARM DEADBOLT AND LATCH UNIT(9V)

The ECL-600 is a fire rated, code-compliant, rugged, dependable relatching exit device with a steel plate and photo-luminescent sign providing managed security and a 100 decibel alarm for secondary fire exits.

DX-ECL-600

DX-ECL-620 OUTSIDE LEVER TRIM FOR ECL-600

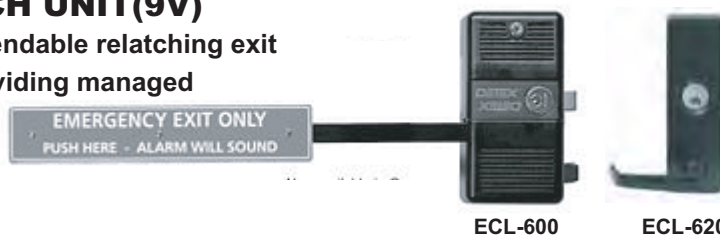

ECL-600

ECL-620



CYLINDER NOT INCLUDED



EXIT ALARM

The Detex EAX-500 is designed for applications that require an alarmed exit device on secured doors. The alarm, with approximately 100dB, will sound when someone attempts an unauthorized exit. The EAX-500, with it's redesigned shape and smaller size make it the choice for quick and easy installations on emergency exit and restricted doors.

DX-EAX-500-KEY#13

SURFACE MOUNTED HARDWIRED TIMED BYPASS EXIT ALARM

The Detex EAX-3500 is designed for applications requiring a hardwired, timed bypass alarm with rechargeable backup battery. The 100-decibel alarm will sound when someone attempts an unauthorized exit. The EAX-3500 can be temporarily bypassed for deliveries and trash removal, but cannot be left disarmed.



DX-EAX-3500SK 24VAC/DC HARDWIRED TIMED BYPASS EXIT ALARM

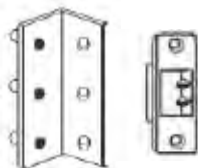

INSWINGING DOORS
For LH, RH
ECL-435K adjustable
strike bracket

DX-ECL-435K

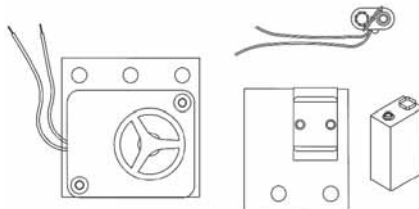

**Siren/Battery Conversion Kit - for
ECL-230C & D. Converts ECL-230
6 volt lantern battery to 9 volt
battery & siren**

DX-ECL-2111K



Outside Key Control Kit;
Product No. EA-523; use
with Detex exit alarms

DX-EA-523

VALUE SERIES PANIC DEVICES

Fast, easy, trouble-free installation. Rugged, durable design with stainless steel self-latching bolt and angled end cap to deflect damage. Tamper-resistant housing protects electronics, battery and internal hardware & prevents manipulation.



State of the art electronics for reliable security & instantaneous alarm. Tamper-resistant security switching electronically monitors latch bolt. 100+ Decibel alarm with adjustable re-arming feature for variable time re-arm. Visual and audible arming indicators. Powered by standard, 9-volt battery. Transformers available. Adjustable time delay (5-30 seconds) allows sufficient time to exit Low-battery alert. Delayed arming feature for arming after door closes. Red Flashing LED alert when not armed

Benefits

- Priced to be the best value for durable and attractive loss prevention panic hardware
- Fast and easy installation
- Patented mounting plate and strike locator
- Covers a 161 door prep
- Stainless steel, 3/4" deadlocking Pullman-type latch bolt
- Non-handed
- Field sizeable

Features

- Minimal door prep saves time and money
- Fits almost any door in any décor
- Outside trims are easily changed or rekeyed without removing device from door
- 1/8 turn hex key dogging
- Heavy-duty angled end cap
- Heavy-duty ribbed aluminum rail extrusion
- High impact ABS and anodized surfaces
- Withstands over 1400 pounds of static pull force for greater security
- Modular design accepts a variety of outside trims and functions
- Standard and narrow stile pull trims available

DX-V40-EB-WEATHERIZED

DX-V40-EB

DX-101879-1-ALUM

WEATHERIZED ALARM PANIC DEVICE

ALARMED EXIT PANIC DEVICE ALUMINUM FINISH

NARROW STILE GLASS DOOR KIT FOR V40

DOM ORIGINAL KEY BLANKS

DM-KBBKL	DOM KEYBLANK	DM-KBBVQ	DOM KEYBLANK
DM-KBBKM	DOM KEYBLANK	DM-KBBVR	DOM KEYBLANK
DM-KBBKN	DOM KEYBLANK	DM-KBBVS	DOM KEYBLANK
DM-KBBKO	DOM KEYBLANK	DM-KBBVT	DOM KEYBLANK
DM-KBBKP	DOM KEYBLANK	DM-KBBVU	DOM KEYBLANK
DM-KBBKQ	DOM KEYBLANK	DM-KBBWL	DOM KEYBLANK
DM-KBBKR	DOM KEYBLANK	DM-KBBWM	DOM KEYBLANK
DM-KBBKS	DOM KEYBLANK	DM-KBBWN	DOM KEYBLANK
DM-KBBKT	DOM KEYBLANK	DM-KBBWO	DOM KEYBLANK
DM-KBBKU	DOM KEYBLANK	DM-KBBWP	DOM KEYBLANK
DM-KBBVL	DOM KEYBLANK	DM-KBBWQ	DOM KEYBLANK
DM-KBBVM	DOM KEYBLANK	DM-KBBWR	DOM KEYBLANK
DM-KBBVN	DOM KEYBLANK	DM-KBBWS	DOM KEYBLANK
DM-KBBVO	DOM KEYBLANK	DM-KBBWT	DOM KEYBLANK
DM-KBBVP	DOM KEYBLANK	DM-KBBWU	DOM KEYBLANK



DM-310-021-3

DOM BEACH MAILBOX LOCK



DM-339-015-1-US15

DOM OVAL CABINET LOCK (PIN CAM)



DM-339-015-2-US15

DOM OVAL CABINET LOCK (FLAT CAM)

SCAR PLATES

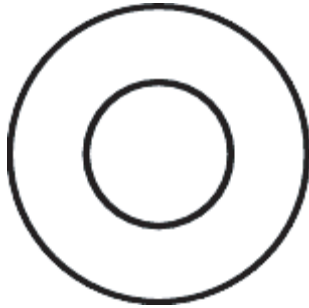

Fits under
deadbolt collars

3-1/2" Outside diameter

Converts 2-3/8" TO 2-3/4"
backset

DJ-DSP-135-605 SCAR PLATE (1-1/2 HOLE)

DJ-DSP-135-630 SCAR PLATE (1-1/2 HOLE)

REMODELER KIT

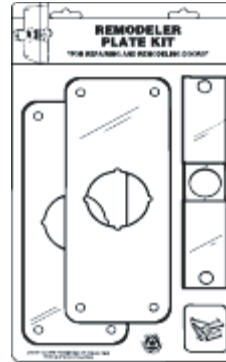

Polished Brass DON-JO
Remodeler Plate Kit
Combines the industry's
strongest door edge unit
with attractive modern
style plates.

DJ-RPK-109-605 POLISHED BRASS

DJ-RPK-109-630 STAINLESS STEEL

FRAME FILLER PLATES

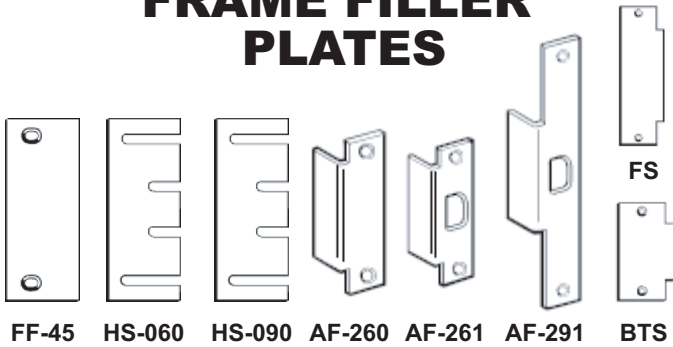

FF-45 HS-060 HS-090 AF-260 AF-261 AF-291 FS BTS

ALL FILLER PLATES ARE PRIME COATED

- DJ-FF-45** 4 1/2" X 1 5/8" FRAME FILLER PLATE
- DJ-FS-260-PC** ANSI CUTOUT
- DJ-HS-060** 4 1/2" HINGE SHIMS - 16 GAGE
- DJ-HS-090** 4 1/2" HINGE SHIMS - 13 GAGE
- DJ-AF-260-SL** 4-7/8 X 1-1/4 ELECTRIC STRIKE FILLER
- DJ-AF-261-SL** ANSI ELECTRIC STRIKE FILLER
- DJ-AF-291-SL** 8" ELECTRIC STRIKE FILLER
- DJ-BTS-160-PC** T STRIKE WITH NO HOLE

HOLE FILLER PLATES

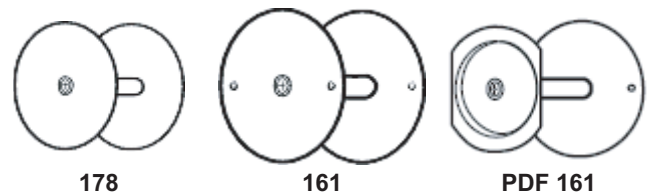

- COVERS UP TO 1 1/2" HOLE, 1 7/8" DIA.**
- DJ-BF-178-BP** FILLER PLATE (1-1/2" HOLE)
- DJ-BF-178-PC** FILLER PLATE (1-1/2" HOLE)
- DJ-BF-178-SL** FILLER PLATE (1-1/2" HOLE)
- COVERS UP TO 2 1/8" HOLE, 2 3/8" DIA.**
- DJ-BF-161-BP** FILLER PLATE (2-1/8 HOLE)
- DJ-BF-161-PC** FILLER PLATE (2-1/8 HOLE)
- DJ-BF-161-SL** FILLER PLATE (2-1/8 HOLE)
- COVERS UP TO 2 1/8" HOLE UNDER PANIC BAR**
- DJ-PDF-161-PC** FILLER PLATE

FILLER PLATES KITS

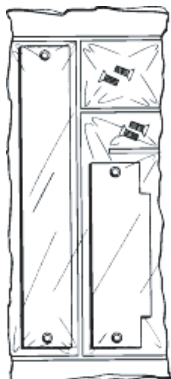

FPK-86

FPK-86 Filler Plate Kit for 86 Cut Out.
Contents include EF-86, FS-260. Prime Coat.

DJ-FPK-86 DON-JO FILLER PLATE KIT

FPK-161 Filler Plate Kit for 161 Cut Out. Contents
include BF-161, EF-161, FS-260. Prime Coat.

DJ-FPK-161 DON-JO FILLER PLATE KIT

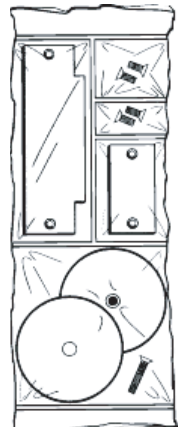

FPK-161

DOOR EDGE FILLER PLATES

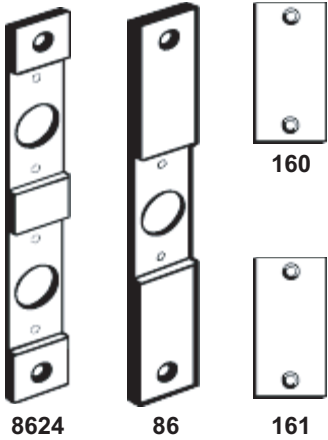

- DJ-CV-8624** 8 X 1-1/4", TWO HOLE PRIME COATED
- DJ-CV-86** 8 X 1-1/4", ONE HOLE PRIME COATED
- DJ-EF-160** 2-1/4" X 1", 160 CUT-OUT
- DJ-EF-161** 2-1/4" X 1-1/8", 161 CUT-OUT
- DJ-EF-634** 6-3/4" X 1", FLUSH BOLT CUT-OUT
- DJ-EF-86** 8" X 1-1/4" X 3/16", 86 CUT-OUT
- DJ-HF-45** 4-1/2" X 1-3/4", DOOR HINGE CUT-OUT

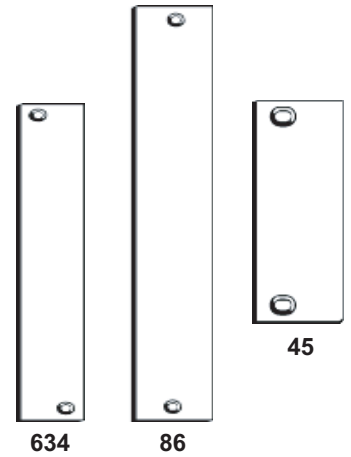

EXTENDED LIP STRIKES

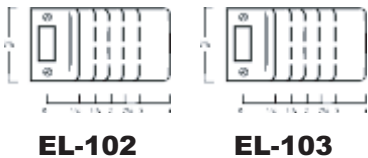

- DJ-EL-102-605** EXTENDED LIP STRIKE (2-1/4 X 2)
- DJ-EL-103-605** EXTENDED LIP STRIKE (2-1/4 X 3)
- DJ-ETS-103-605** EXTENDED LIP STRIKE

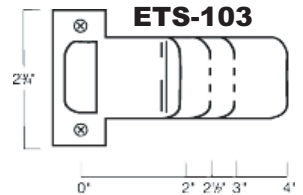

12 & 18 SERIES SECURITY STRIKES



Single hole version designed to work with key-in-knob or deadbolt Double hole version designed to accomodate both 3 5/8" & 4" centered locksets

- DJ-FL-212W-BP** 12 INCH STRIKE (ONE HOLE)
- DJ-FL-212W4-BP** 12 INCH STRIKE (4 INCH CENTRES, TWO HOLE)
- DJ-FL-212W6-BP** 12 STRIKE (6 INCH CENTRES) (TWO HOLE)
- DJ-FL-212W6-SL** 12 STRIKE (6 INCH CENTRES) (TWO HOLE)

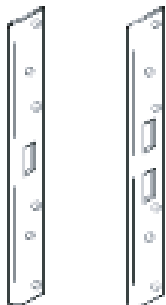

- DJ-AST-21341-BP** 18 INCH ARMOR STRIKE (CENTRE SINGLE HOLE)
- DJ-AST-21341-SL** 18 INCH ARMOR STRIKE (CENTRE SINGLE HOLE)
- DJ-AST-21342-BP** 18 INCH ARMOR STRIKE (2 HOLE, 4 INCH CENTRE)
- DJ-AST-21346-BP** 18 INCH ARMOR STRIKE (2 HOLE, 6 INCH CENTRE)

DEADBOLT STRIKES

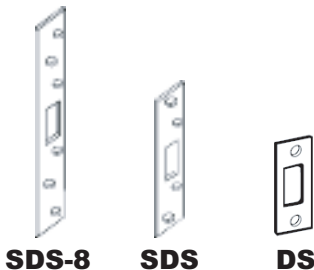

- DJ-2-SDS-8-BP** SECURITY STRIKE 8 X 1-3/8 INCH
- DJ-2-SDS-8-SL** SECURITY STRIKE 8 X 1-3/8 INCH
- DJ-2-SDS-BP** SECURITY STRIKE 4-7/8 X 1-1/4 INCH
- DJ-DS-234-630** DEADBOLT STRIKE

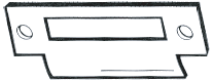

DJ-MST-261-SL ASA MORTISE TYPE STRIKE, 4 7/8" x 11/4"



DJ-TS-100-CP THIMBLE STRIKE 1" DIAMETER

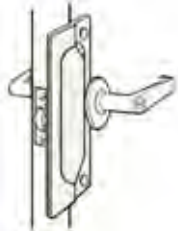

LP/BLP-207

FOR OUTSWINGING DOORS. MADE OF SOLID BRASS AND FURNISHED WITH WASHERS, CARRIAGE BOLTS AND CAP NUTS

- DJ-LP-207-DU** LATCH PROTECTOR 2-3/4" x 7", BROWN
- DJ-LP-207-SL** LATCH PROTECTOR 2-3/4" x 7", SILVER
- DJ-BLP-207-DU** LATCH PROTECTOR FOR K.I.L LOCKS UP TO 3-3/4"

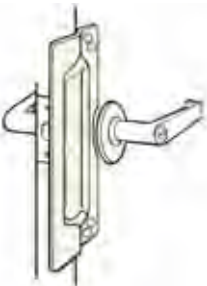

LP-211/111

FOR OUTSWINGING DOORS. MADE OF HEAVY GAUGE STEEL AND FURNISHED WITH WASHERS, CARRIAGE BOLTS AND CAP NUTS

- DJ-LP-111-630** LATCH PROTECTOR 11" X 3" STAINLESS STEEL
- DJ-LP-211-BP** LATCH PROTECTOR 11" X 3" BRASS
- DJ-LP-211-DU** LATCH PROTECTOR 11" X 3" BROWN
- DJ-LP-211-SL** LATCH PROTECTOR 11" X 3" SILVER

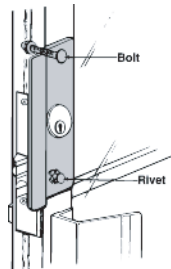

LP-307

FOR ALUMINUM ENTRANCE DOORS SOLVES PULL HANDLE INTERFERENCE. WILL FIT OVER CYLINDER, LOCK REMOVAL IS NOT REQUIRED.

- DJ-LP-307-DU** LATCH PROTECTOR 2-5/8" X 7-1/8" BROWN
- DJ-LP-307-SL** LATCH PROTECTOR 2-5/8" X 7-1/8" SILVER

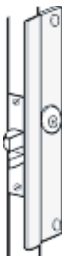

LP-312

FOR ALUMINUM OUTSWINGING DOORS. MADE OF HEAVY GAUGE STEEL AND REVERSIBLE. FEATURES A 1/4" OFFSET, 1-7/16" HOLE AND A 1-1/8" BACKSET.

- DJ-LP-312-SL** LATCH PROTECTOR
- DJ-LP-312P-DU** LATCH PROTECTOR (NO HOLE)



SLP-206

FOR OUTSWINGING DOORS AND MADE OF STEEL. FURNISHED WITH WASHERS, ACORN NUTS. MAY BE USED ON HOLLOW METAL DOORS.

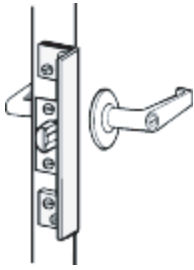

ALP-206

**FOR OUTSWINGING DOORS AND MADE OF STEEL.
6" FOR KEY-IN-KNOB/LEVER AND 10" FOR MORTISE LOCKS.
1-1/2" SHEET METAL SCREWS FOR WOOD OR METAL.**

- DJ-ALP-206-BC** 6" ANGLE LATCH PROTECTOR
- DJ-ALP-206-DU** 6" ANGLE LATCH PROTECTOR
- DJ-ALP-206-SL** 6" ANGLE LATCH PROTECTOR
- DJ-ALP-210-SL** 10" ANGLE LATCH PROTECTOR

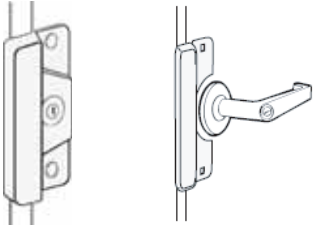

ELP-208

LELP-208

**FOR USE WITH ELECTRIC STRIKES. MADE OF HEAVY GAUGE
STEEL AND DESIGNED TO WORK WITH MOST ELECTRIC STRIKES**

- DJ-ELP-208-DU** COVER PLATE FOR ELECTRIC STRIKE
- DJ-ELP-208-SL** COVER PLATE FOR ELECTRIC STRIKES
- DJ-ELP-208P-SL** COVER PLATE FOR ELECTRIC STRIKE, NO CYLINDER HOLE
- DJ-FLP-111-630** FOR FOLGER ADAMS STRIKE 1-3/4" x 11-1/4"
- DJ-LELP-208-DU** LATCH PROTECTOR
- DJ-LELP-208-SL** LATCH PROTECTOR

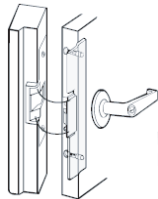

ELP-208

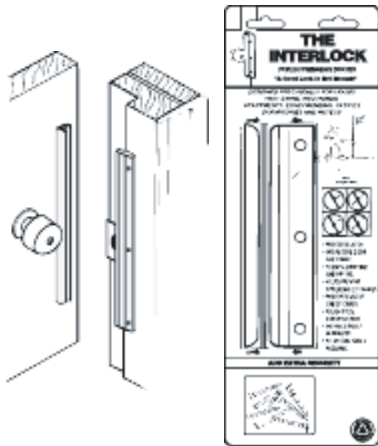

**FOR INSWINGING DOORS. INTERLOCKS DOOR AND FRAME TO
RESIST JIMMYING AND PRYING. HELPS PREVENT THE SPREADING
OF THE FRAME.**

- DJ-ILP-206-BP** 6" THE INTERBLOCK
- DJ-ILP-206-DU** 6" THE INTERBLOCK
- DJ-ILP-206-SL** 6" THE INTERBLOCK
- DJ-ILP-212-BP** 12" THE INTERBLOCK
- DJ-ILP-212-SL** 12" THE INTERBLOCK



EXTRA HEAVY DUTY DOOR CHECK CHAIN

- DJ-HDCC-3012-626** 30 1/2" IN LENGTH, COMES WITH A
GRAY VINYL COVER

REPLACEMENT RIVETS

- DJ-RIVOT-DURODONIC** RIVOT (DURODONIC)
- DJ-RIVOT-SILVER** RIVOT (SILVER)

The DOOR GUARDIAN, a revolutionary keyless door lock guaranteed to provide protection and peace of mind, its uniquely locking mechanism keeps intruders where they belong - on the outside. It mounts inside on the door frame with just a screw driver. Your family's safety and security is what the patented DOOR GUARDIAN will provide you. It will improve your home's safety by preventing anyone from entering while you are at home, it's proven stronger than a deadbolt lock. Door Guardian's are the perfect protection for all doors with outside exposure.



Door Guardian

Resists forced entry and is 12X stronger than a deadbolt

DG-DG01-AB ANTIQUE BRASS

DG-DG01-B BRASS

DG-DG01-SC SATIN CHROME

The Patio Door Guardian

The Patio Door Guardian Lock effectively childproofs your patio sliders providing peace of mind for you and your family.



Patio Door Guardian

2 position spring loaded with left and right stop.

Keeper Plate allows for a 3" ventilation without minimizing security.

DG-PDG01-WHITE
PATIO DOOR LOCK (WHITE)

CONCEALED FLOOR DOOR CLOSER



Complete range for every application. 2 Simple stock holding thanks to identical accessories being used throughout the DORMA BTS range. Proven, robust unit – for doors weighing up to 300 kg.

DD-BTS80-2	FLOOR CLOSER (BODY ONLY)
DD-BTS80-CEMENT-BOX	CEMENT BOX ONLY FOR BTS80 (BOX ONLY)
DD-74003	5/16" CENTRE HUNG SPINDLE FOR BTS80
DD-74010	3/4" CENTRE HUNG SPINDLE FOR BTS80
DD-7422-689	BOTTOM ARM FOR BTS80

CONCEALED OVERHEAD DOOR CLOSER

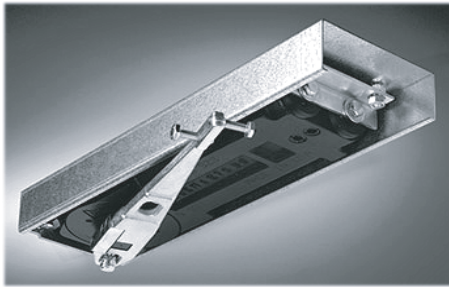

Invisible Door Control . . Dependable and Easy to Install. DORMA RTS88 overhead concealed door closer offers the perfect solution for those who prefer the aesthetic advantages of a concealed door closer.

The RTS88 is designed to give lasting, dependable service where surface applied units and other types of closers are not suitable, or would interfere with the architectural design.

DD-RTS88-105-HO-SZ3	OVERHEAD DOOR CLOSER BODY ** HOLD OPEN **
DD-RTS88-105-NHO-SZ3-5MM	OVERHEAD DOOR CLOSER BODY (105 DEGREE - 5MM)
DD-RTS88-105-NHO-SZ3	OVERHEAD DOOR CLOSER BODY ONLY (105 DEGREE)
DD-RTS88-90-HO-SZ3-5MM	OVERHEAD DOOR CLOSER BODY ** HOLD OPEN ** (90 DEGREE - 5MM)
DD-RTS88-90-NHO-SZ3-5MM	OVERHEAD DOOR CLOSER BODY (90 DEGREE - 5MM)
DD-RTS88-90-NHO-SZ3	OVERHEAD DOOR CLOSER BODY (90 DEGREE)
DD-8831	SIDE LOAD ARM FOR RTS88
DD-8836-2G	END LOAD ARM FOR RTS88-5MM DOOR CLOSER

TS77

The economical solution for standard doors. Non-handed, suitable for standard, parallel arm and frame installation, Fully controlled closing cycle.



DD-TS77-2AL	SIZE-2 DOOR CLOSER
DD-TS77-3AL	SIZE-3 DOOR CLOSER

7400 SERIES

Small footprint closer with adjustable spring settings. Grade 1 quality offers reliability for high-traffic applications. Can mount on narrow 2" aluminum door or frame rails.



DD-7436-ARP-689-BP640C	DOOR CLOSER WITH PA/640 BRACKET
-------------------------------	---------------------------------

CENTRE HUNG PIVOTS



DD-8062-630
WALKING BEAM PIVOT



DD-8852
SHORT FLOOR PIVOT

DD-8853
TALL FLOOR PIVOT



DD-8855
SHORT THRESHOLD PIVOT

DD-8857
TALL THRESHOLD PIVOT

1990 Series Concealed Vertical Rod Device

The Industry Standard For Aluminum Door Exit Devices. The 1990's classic look and a long history of reliable performance has made the 1990 the #1 selling exit device for aluminum doors. This ANSI Grade 1 device features hardened steel latches and is compatible with stiles as narrow as 1 3/4". The 1990 device is equipped with hardened steel latches and an adjustable strike to ensure safety, security and quiet operation.

DO-1990EO-P13

CONCEALED VERTICAL ROD DEVICE (DURODONIC)

DO-1990EO-P28

CONCEALED VERTICAL ROD DEVICE (ALUMINUM)

**2090 Series Rim Crossbar Device**

Classic Looks In A Rim Exit Device. The 2090's balanced appearance, dependable performance, and economical pricing has made it a popular choice where rim exit devices are required. Equipped with a 1/2" throw steel latchbolt, the 2090 can be mounted on stiles as narrow as 1 3/4". Removable mullions are available for pairs of doors applications. The 2090 is an ANSI Grade 1 device.

DO-2090-LHRB-P13

LEFT-HAND REVERSE (DURODONIC)

DO-2090-LHRB-P28

LEFT-HAND REVERSE (ALUMINUM)

DO-2090-RHRB-P13

RIGHT-HAND REVERSE (DURODONIC)

DO-2090-RHRB-P28

RIGHT-HAND REVERSE (ALUMINUM)

**DO-PB5**

DOROMATIC PINION GEAR





EDWARDS #9 ELECTRIC STRIKE

For use in new or replacement installations in wood and metal jambs. For use with locksets having up to 5/8" throw.*

8-16 VAC/4-6 VDC (Standard Voltage)

FEATURES

FACE PLATE – 1-7/16" X 5-7/8"

DURABILITY – 500,000 Life cycles

HOLDING FORCE – 1100 lbs.

AUXILIARY LEVER RAMPS - 2-7/8"; – For locksets with auxiliary dead locking levers

SOLID CAST LATCH – Chrome Plated Cavity Depth - 1/2"; Width - 9/16"; Height - 1-3/8"

NON-HANDED HEAVY DUTY LATCH SPRING

MORTISE TYPE – Backset 1-9/16" Deep

FAIL SECURE – (Standard Action) Unlocks When Energized

ONE-PIECE RELEASE MECHANISM

ED-9 TRINE-EDWARD ELECTRIC STRIKE (8-16 VAC)

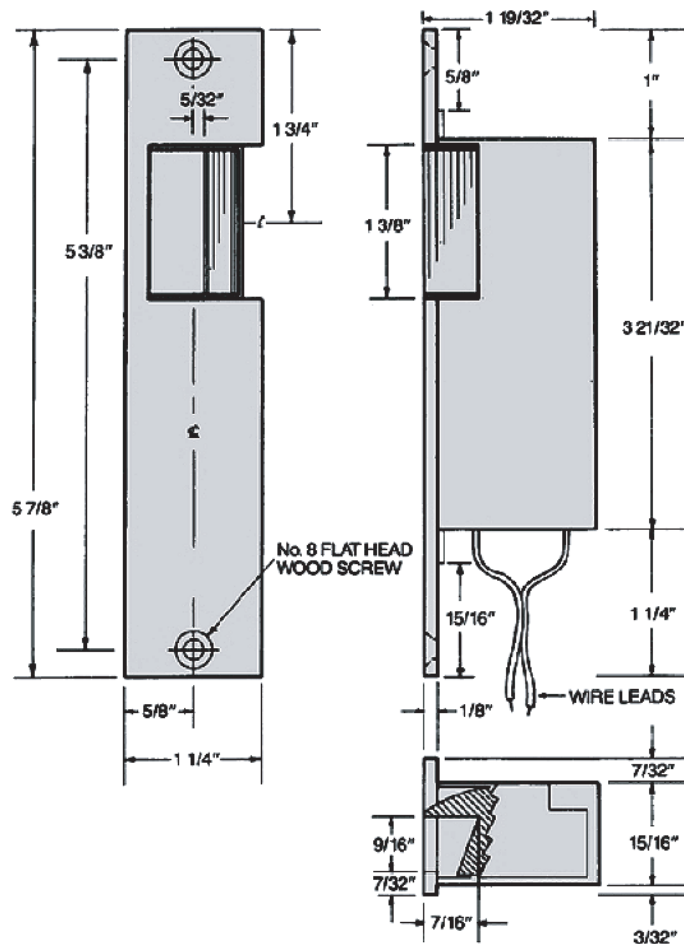



Emtek Entrysets are solid forged brass and generously proportioned to make a dramatic visual statement.

SARATOGA



EM-4410-SARATOGA-EGGKNOB-PVD/US3
EM-4410-SARATOGA-EGGKNOB-US15
EM-4410-SARATOGA-EGGKNOB-US10B

MARIETTA



EM-4411-MARIETTA-EGGKNOB-PVD/US3
EM-4411-MARIETTA-EGGKNOB-US15
EM-4411-MARIETTA-EGGKNOB-US10B

Polished Life-Time Brass
Satin Nickel
Oil Rubbed Bronze

Polished Life-Time Brass
Satin Nickel
Oil Rubbed Bronze

KNOXVILLE



EM-4310-KNOXVILLE-EGGKNOB-PVD/US3
EM-4310-KNOXVILLE-EGGKNOB-US15
EM-4310-KNOXVILLE-EGGKNOB-US10B

Polished Life-Time Brass
Satin Nickel
Oil Rubbed Bronze

All 3 Gripset Designs
Shown Are Stocked With
Egg Knob Interior Trims
Which Makes Them All
Non-Handed



*NOTE: ALL GRIPSETS ARE STOCKED WITH 2-3/4" BACKSETS * 2-3/8" ON REQUEST **

LOW PROFILE DEADBOLTS

Low Profile Deadbolt available in 5 Finishes. Extension collar for thin doors shipped with every deadbolt. Schlage C 5-pin Keyway. Standard Door Prep and Installation. Solid Brass Bolt, Cylinder, Housing, Collar and Rosette. 2-3/4" backset Bolt supplied standard.

EM-8455-PVD-2-3/4	SINGLE CYLINDER, LIFETIME POLISHED BRASS FINISH
EM-8455-US15-2-3/4	SINGLE CYLINDER, SATIN NICKLE FINISH
EM-8455-US15A-2-3/4	SINGLE CYLINDER, PEWTER FINISH
EM-8455-US3-2-3/4	SINGLE CYLINDER, POLISHED BRASS FINISH
EM-8455-US5-2-3/4	SINGLE CYLINDER, ANTIQUE BRASS FINISH
EM-8455-US7-2-3/4	SINGLE CYLINDER, FRENCH ANTIQUE
EM-8455-US10B-2-3/4	SINGLE CYLINDER, OIL RUBBED BRONZE



*NOTE: ALL GRIPSETS ARE STOCKED WITH 2-3/4" BACKSETS * 2-3/8" ON REQUEST **

REPLACEMENT BOLTS AND LATCHES

EM-BOLT-2-3/4-US3	2-3/4" BACKSET BOLT ONLY FOR DEADBOLTS, LIFETIME BRASS
EM-BOLT-2-3/8-(US10B,US3,US7,US15)	2-3/8" BACKSET BOLT ONLY FOR DEADBOLTS
EM-PASSAGE-LATCH-2-3/4	PASSAGE LATCH ONLY (2-3/4 BACKSET)
EM-PASSAGE-LATCH-2-3/8	PASSAGE LATCH ONLY (2-3/8 BACKSET)
EM-PRIVACY-LATCH-2-3/4	PRIVACY LATCH ONLY (2-3/4 BACKSET)



HIDE-A-KEY KEEPER

Its the "original" magnetic key holder. Features the extra powerful double size magnet. Hide-A-Keys are magnetically attached to 11-1/4" x 14-1/8" metal display board. 12 hide a keys per board. Made in the USA.

ES-HAK1 HIDE-A-KEY KEEPER (12 PER CARD)



DOOR AND LOCK SUPPORT

Here's the answer you've been looking for to completely eliminate all collapsing and loosening problems when installing locks on hollow metal doors! The Ames Door & Lock Support is both flexible and adjustable, thus assuring use for any locks requiring 2 1/8", 1 5/8" or 1 1/2" cross bores.

ES-A1346 ESP DOOR & LOCK SUPPORT FOR HOLLOW METAL DOORS

NOTES:

INDUSTRIAL GRADE ELECTRIC STRIKE FOR CYLINDRICAL LOCKSETS

For a 1/2" or 5/8" throw latchbolt
(without deadbolt) on single and pairs of doors

FO-310-2-12VDC-32D-NFS FOR CYLINDRICAL LOCK (1/2 OR 5/8)
FO-310-2-24VDC-32D-NFS FOR CYLINDRICAL LOCK (1/2 OR 5/8)

NFS - NO POWER AND THE STRIKE STAYS LOCKED



INDUSTRIAL GRADE ELECTRIC STRIKE FOR RIM EXIT DEVICES

For a rim exit device having a pullman style
latchbolt - used on a single door opening or the
top of a surface vertical-rod exit device

The 310-4 faceplate converts from 3/4" to 1/2" thickness standard

FO-310-4-12VDC-32D-NFS FOR RIM PANIC DEVICE
FO-310-4-24VDC-32D-NFS FOR RIM PANIC DEVICE

NFS - NO POWER AND THE STRIKE STAYS LOCKED



**ELECTRIC STRIKE FOR CYLINDRICAL LOCKSETS IN
HOLLOW METAL FRAMES**

For hollow-metal frame applications - when the
lockset has a 1/2" or 5/8" throw latchbolt

FO-712-12VDC-32D-NFS FOR CYLINDRICAL LOCK (ANSI)
FO-712-24VDC-32D-NFS FOR CYLINDRICAL LOCK (ANSI)

NFS - NO POWER AND THE STRIKE STAYS LOCKED

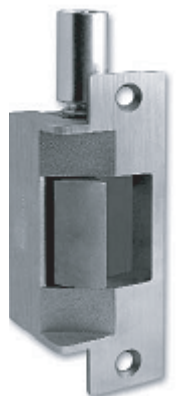

The concept of **Multi-Function** is to make one bag of components available to produce many different functioning locks (up to 6 different functions in our single bitted lock bag). ***This enables you to carry fewer locks in inventory*** while still having complete stock on hand. Multi-Function bagged cam locks include our patented Wonder Washer, which allows for installation into either wood or metal without the use of a double "D" punch.

MULTI-FUNCTION CAM LOCKS SILVER IN FINISH

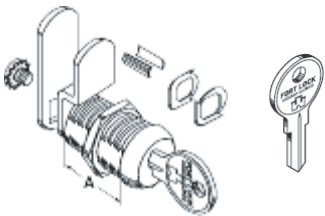

FT-MFW-23038	3/8"
FT-MFW-23038KA-217	3/8"
FT-MFW-23038KA-221	3/8"
FT-MFW-23058	5/8"
FT-MFW-23058KA-217	5/8"
FT-MFW-23058KA-221	5/8"
FT-MFW-23078	7/8"
FT-MFW-23078KA-217	7/8"
FT-MFW-23078KA-221	7/8"
FT-MFW-23118	1-1/8"
FT-MFW-23118KA-217	1-1/8"
FT-MFW-23118KA-221	1-1/8"
FT-MFW-23138	1-3/8"
FT-MFW-23138KA-217	1-3/8"
FT-MFW-23138KA-221	1-3/8"

MULTI-FUNCTION TUBULAR (GEM) KEYWAY CAM LOCKS SILVER IN FINISH

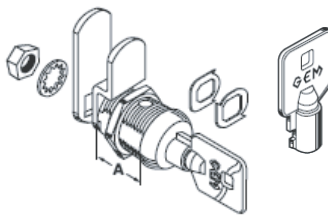

FT-MFW-1038	3/8"
FT-MFW-1038KA-379	3/8"
FT-MFW-1058	5/8"
FT-MFW-1058KA-379	5/8"
FT-MFW-1078	7/8"
FT-MFW-1078KA-379	7/8"
FT-MFW-1118	1-1/8"
FT-MFW-1118KA-379	1-1/8"
FT-MFW-1148	1-1/2"
FT-MFW-1148KA-379	1-1/2"

**METAL DUST CAP
FOR CAM LOCKS
FT-DC1**



MULTI-FUNCTION TUBULAR (GEM) KEYWAY SWITCH LOCKS SILVER IN FINISH



FT-MFSW3-1138	1-3/8"
FT-MFSW3-1138KA-379	1-3/8"

SHOWCASE LOCKS SILVER IN FINISH

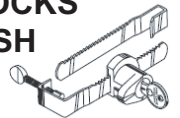

FT-MFW-SG23000
FT-MFW-SG23000KA-217

BYPASS LOCKS SILVER IN FINISH



FT-SD990-KA-217

POP OUT CYLINDER FOR T-HANDLES

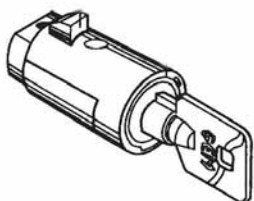

FT-YPT1010	KEYED DIFFERENT
FT-YPT1010KA-379	KEYED ALIKE

RE-KEYING KITS

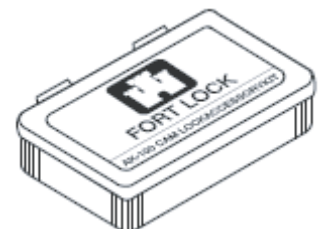

FT-RKK-110	RE-KEYING KIT (1000 SERIES TUBULAR)
FT-RKK-130	RE-KEYING KIT (23000 SERIES WAFER)

100 SERIES

OVERHEAD CONCEALED DOOR STOP/HOLDER



Glynn-Johnson 100 series holders and stops provide the most reliable and versatile concealed overhead door control. They are designed for installation on virtually all types of doors mounted on conventional type butt hinges, pivots, continuous hinges, swing clear hinges and numerous other specialty hinges. When used in conjunction with many surface-applied door closers, 100 series holders and stops provide the most effective control for entrance doors and vestibule doors of all types, as well as heavy or often used interior doors. Templates provided allow for variable mounting positions, ranging from 85° - 110° of opening.

- GJ-104-H-630 OVERHEAD STOP WITH HOLD-OPEN, STAINLESS STEEL
- GJ-104-S-630 OVERHEAD STOP, STAINLESS STEEL

90 SERIES

OVERHEAD SURFACE DOOR STOP/HOLDER



Glynn-Johnson 90 series holders and stops are the most rugged models available for heavy-duty applications. The channel is surface-mounted to the door, most often with six bolts, and the jamb bracket is surface mounted to the jamb, requiring minimal door and frame preparation. These versatile units can be used in conjunction with most surface-applied door closers. The provided templates allow for variable mounting positions, ranging from 85° to 110° Hold-Open/Stop angle. These templates are designed for installation in almost all types of doors, including doors with conventional butt-type hinges or specialty hinges.

- GJ-904-H-630 OVERHEAD STOP WITH HOLD-OPEN, STAINLESS STEEL
- GJ-904-S-630 OVERHEAD STOP, STAINLESS STEEL

ROTON HINGES

Hager-Roton Continuous Geared Hinges provide long-lasting solutions for high-traffic and high-impact doors, extending the life of the total door opening. Whether for retrofit projects or new construction, Roton can supply the needed hinge for your applications. The continuous geared hinge extends the full length of the door and frame. The two center gears form a rotating joint, both leaves share the common cover channel and roll when they come in contact, minimizing lateral wear. Hager-Roton Continuous Geared Hinges will solve all of your door hanging problems.

HEAVY DUTY CONTINUOUS HINGES

HH-780-053- HD -CLEAR	HALF SURFACE, 83"
HH-780-057- HD -BRONZE	NARROW FULL SURFACE, 83"
HH-780-057- HD -CLEAR	NARROW FULL SURFACE, 83"
HH-780-112- HD -BRONZE	MORTISE, 83"
HH-780-112- HD -CLEAR	MORTISE, 83"
HH-780-157- HD -BRONZE	NARROW FULL SURFACE, 83"
HH-780-157- HD -CLEAR	NARROW FULL SURFACE, 83"
HH-780-210- HD -BRONZE	FULL SURFACE, 83"
HH-780-210- HD -CLEAR	FULL SURFACE, 83"
HH-780-210- HD -BRONZE-95	FULL SURFACE CONTINUOUS HINGE (95")
HH-780-210- HD -CLEAR-95	FULL SURFACE CONTINUOUS HINGE (95")
HH-780-224- HD -BRONZE-83	FULL MORTISE CONTINUOUS HINGE WITH LIP
HH-780-224- HD -CLEAR-83	FULL MORTISE CONTINUOUS HINGE WITH LIP

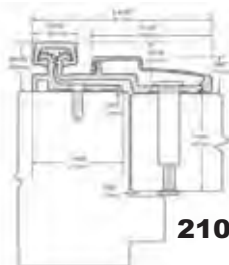
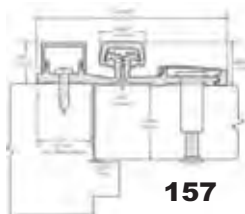
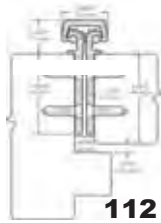

HH-780-052M-MOULDING-BRONZ	CAP FOR 780-057, DOOR SIDE, BRONZE
HH-780-210-MOULDING-BRONZ	CAP FOR 780-210 (BRONZE)
HH-780-210-MOULDING-CLEAR	CAP FOR 780-210 (CLEAR)
HH-780-247-MOULDING-CLEAR	CAP FOR 780-157, FRAME SIDE
HH-780-247MOULDING-BRONZE	CAP FOR 780-157, FRAME SIDE, BRONZE



MEDIUM DUTY CONTINUOUS HINGES

HH-780-210-CLEAR	FULL SURFACE, 83"
HH-780-210-BRONZE	FULL SURFACE, 83"
HH-780-157-BRONZE (SL57)	NARROW FULL SURFACE, 83"
HH-780-157-CLEAR (SL57)	NARROW FULL SURFACE, 83"

HEAVY WEIGHT HINGES



HH-1502-26D	4-1/2" X 4" SPRING HINGE [UL]
HH-BB1191-4.5X4-26D-ETW8	4-1/2" X 4" ELECTRIFIED HINGE (8 WIRE)
HH-BB2273NRP-PT	4-1/2" HALF SURFACE BALL BEARING HINGE (NRP)



GRADE 1 INDUSTRIAL LEVER LOCKSETS

FEATURES

- **UL / ULC Listed - 3 Hour Fire Rating**
- **ADA Compliant**
- **For 1 5/8" - 2" Thick Door**
- **Optional Removable Posts**
- **ANSI Strike Standard**
- **CLUTCHED Freewheeling Lever**
- **Spring Loaded Roses - No Lever Sag**
- **Stainless Steel Chassis**
- **6 pin "C" Keyway Cylinder Standard**
- **1/2" Throw Deadlatch**
- **2 3/4" Backset (2 3/8" avail.)**
- **Satin Chrome Finish**
- **Non-Handed**

HALSCO Cylindrical Grade 1 Industrial Lever Locksets are designed for use in high traffic and abusive situations where durability is the deciding factor. Our cylindrical lock chassis are all constructed with cast retractors on bronze roller bearings. This strong, durable component gives our cylindrical sets the ability to last millions of cycles. This ANSI Grade 1 Industrial cylindrical lever lockset features a lever lock with large, long-lasting lever springs, a Heavy Duty Halsco latch, and removable through-posts for optional mounting. It is available in 6-pin C keyway and in five basic functions all in a 626 finish. Available in 2-3/4" backset 2-3/8" available.

Ideally Suited For:
Offices, Schools, Colleges / Universities,
Hospitals and Manufacturing Facilities.



HA-ML10-626

PASSAGE LEVER LOCKSET

HA-ML40-626

PRIVACY LEVER LOCKSET

HA-ML53-626

ENTRANCE LEVER LOCKSET

HA-ML53-626-CLUTCH

ENTRANCE LEVER LOCKSET

HA-ML53-626-I/C

ENTRANCE LEVER LOCKSET (6-7 PIN SFIC)

HA-ML53-626-I/C-CLUTCH

ENTRANCE LEVER LOCKSET (6-7 PIN SFIC)

HA-ML70-626

CLASSROOM LEVER LOCKSET

HA-ML70-626-CLUTCH

CLASSROOM LEVER LOCKSET (CLUTCH)

HA-ML70-626-I/C

CLASSROOM LEVER LOCKSET (6-7 PIN SFIC)

HA-ML70-626-I/C-CLUTCH

CLASSROOM LEVER LOCKSET (6-7 PIN SFIC)

HA-ML80-626

STOREROOM LEVER LOCKSET

HA-ML80-626-CLUTCH

STOREROOM LEVER LOCKSET

HA-ML80-626-I/C

STOREROOM LEVER LOCKSET (6-7 PIN IC)

HA-ML80-626-I/C-CLUTCH

STOREROOM LEVER LOCKSET (6-7 PIN SFIC)

HA-ML-234-DEADLATCH

HALSCO GRADE 1 DEADLATCH (2-3/4 BACKSET)

HA-ML-234-SPRINGLATCH

HALSCO GRADE 1 SPRINGLATCH (2-3/4 BACKSET)



GRADE 1 COMMERCIAL RIGID & CLUTCH LEVER LOCKSETS



- UL / ULC Listed
- ADA Compliant
- For 1 3/8" - 2" thick door
- Through bolt installation
- ANSI strike standard
- CLUTCHED Freewheeling lever
- Stainless Steel Chassis
- 6 pin "C" keyway cylinder standard
- 1/2" throw deadlatch
- 2 3/4" backset (2 3/8" avail.)
- Satin chrome finish
- Non-handed

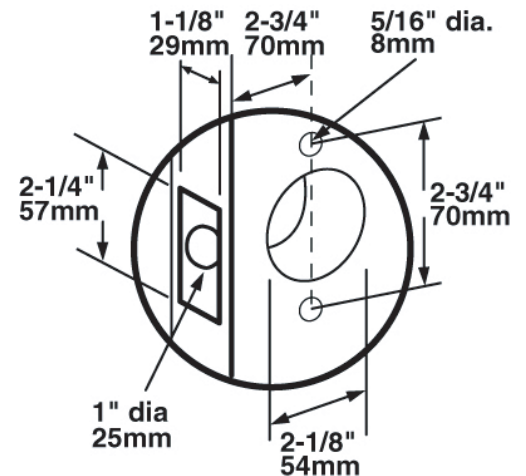
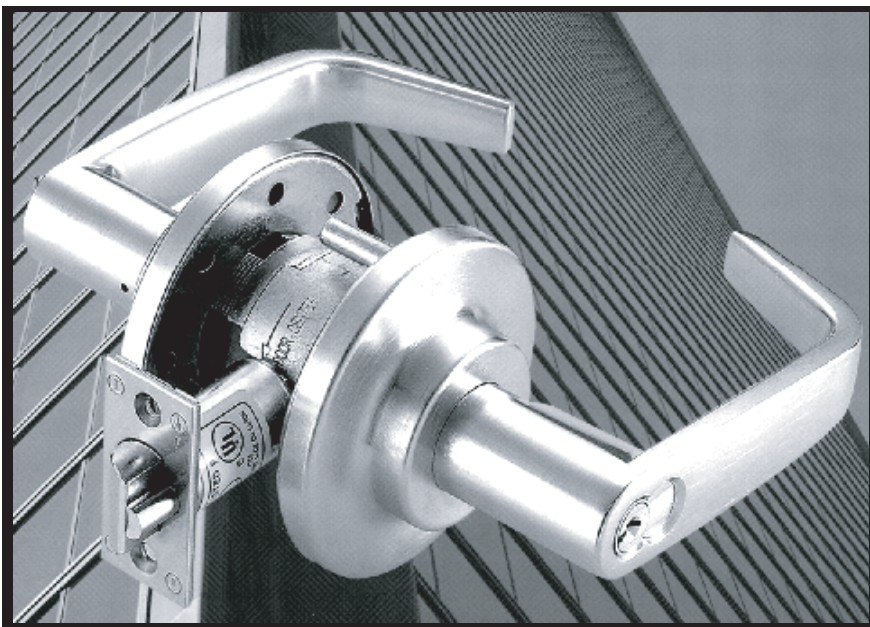

HA-DL10-26D

HA-DL40-26D

HA-DL52-26D

HA-DL53-26D

HA-DL53-IC-LC-26D

HA-DL53CH-26D-CLUTCH

HA-DL70-26D

HA-DL70-IC-LC-26D

HA-DL70CH-26D-CLUTCH

HA-DL80-26D

HA-DL80-IC-LC-26D

HA-DL80CH-26D-CLUTCH

HA-DL82-26D

HA-D234-DL

HA-D238-DL

GRADE 1 LEVER PASSAGE LOCKSET

GRADE 1 LEVER PRIVACY LOCKSET

GRADE 1 LEVER LOCKSET (CLASSROOM SECURITY)

GRADE 1 LEVER ENTRANCE LOCKSET

GRADE 1 LEVER ENTRANCE LOCKSET (IC CORE)

GRADE 1 LEVER LOCKSET (ENTRANCE - CLUTCH)

GRADE 1 LEVER CLASSROOM LOCKSET

GRADE 1 LEVER CLASSROOM LOCKSET (IC CORE)

GRADE 1 LEVER LOCKSET (CLASSROOM - CLUTCH)

GRADE 1 LEVER STOREROOM LOCKSET

GRADE 1 LEVER STOREROOM LOCKSET (I/C CORE)

GRADE 1 LEVER LOCKSET (STOREROOM - CLUTCH)

GRADE 1 DOUBLE CYLINDER STOREROOM LOCKSET

HALSCO GRADE 1 DEADLATCH (2-3/4 BACKSET)

HALSCO GRADE 1 DEADLATCH (2-3/8 BACKSET)

GRADE 1 INDUSTRIAL KNOB LOCKSETS

FEATURES

- UL / ULC Listed - 3 Hour Fire Rating
- For 1 5/8" - 2" Thick Door
- Accepts most manufacturers cylinders
- 6 pin "C" Keyway Cylinder Standard
- 1/2" Throw Deadlatch
- 2 3/4" Backset (2 3/8" avail.)
- Stainless Steel (630) Finish
- Non-Handed
- ANSI Strike Standard

HALSCO Cylindrical Grade 1 Industrial Knob Locksets are designed for use in high traffic and abusive situations where durability is the deciding factor. Our cylindrical lock chassis are all constructed with cast retractors on bronze roller bearings. This strong, durable component gives our cylindrical sets the ability to last millions of cycles. This ANSI Grade 1 Industrial cylindrical Knob lockset features a Heavy Duty Halsco Deadlatch. Available in 6-pin C keyway and in six functions all in a (630) stainless steel finish. Available in 2-3/4" backset 2-3/8" available.

Ideally Suited For:
Offices, Schools, Colleges / Universities,
Hospitals and Manufacturing Facilities.



- | | |
|------------------------|---|
| HA-D10RSS | GRADE 1 PASSAGE KNOB LOCKSET |
| HA-D40RSS | GRADE 1 PRIVACY KNOB LOCKSET |
| HA-D53RSS | GRADE 1 ENTRANCE KNOB LOCKSET |
| HA-D53RSSLC | GRADE 1 ENTRANCE LOCKSET (LESS CYLINDER) |
| HA-D53RSS-LC-IC | GRADE 1 ENTRANCE LOCKSET (6/7 PIN I/C CORE) |
| HA-D70RSS | GRADE 1 CLASSROOM KNOB LOCKSET |
| HA-D70RSSLC | GRADE 1 CLASSROOM LOCKSET (LESS CYLINDER) |
| HA-D70RSS-LC-IC | GRADE 1 CLASSROOM LOCKSET (6/7 PIN I/CORE) |
| HA-D72RSS | GRADE 1 DOUBLE CLASSROOM LOCKSET |
| HA-D80RSS | GRADE 1 STOREROOM KNOB LOCKSET |
| HA-D80RSSLC | GRADE 1 STOREROOM LOCKSET (LESS CYLINDER) |
| HA-D80RSS-LC-IC | GRADE 1 STOREROOM LOCKSET (6/7 PIN I/C CORE) |
| HA-D82RSS | GRADE 1 DOUBLE CYLINDER STOREROOM LOCKSET |
| HA-D234-DL | GRADE 1 DEADLATCH (2-3/4 BACKSET) |
| HA-D238-DL-SS | GRADE 1 DEADLATCH (2-3/8 BACKSET) |
| HA-D238-SS | GRADE 1 SPRING LATCH (2-3/8 BACKSET) |

GRADE 1 INDUSTRIAL CONCEALED INTERCHANGEABLE-CORE DEADBOLT

Perfect for apartment buildings or situations where tenants should not change or remove deadbolts on their own



1. No exposed mounting screws standard
2. Full 1" stainless steel throw deadbolt
3. Free-turning, wrench-resistant, tapered cylinder ring
4. solid extruded brass cylinder with brass shell
5. Stainless steel for strength and corrosion resistance
6. Simple installation; self-aligning and reversible
7. May be keyed into existing Best masterkeyed system
8. The interchangeable core permits instant re-lock
9. American National Standard ANSI A156.5-1992 Auxiliary Locks, Grade 1 with 1CD Core and strike
10. ADA turn lever (Not shown)
11. Deadbolt UL listed for use as auxiliary lock type on 3 hr. fire doors (GWXT). These locks also carry the C-UL mark which is now officially accepted in all of Canada, indicating compliance with appropriate Canadian standards and codes

Fits doors - from 1-3/8" to 3"

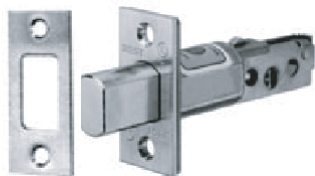

Deadbolt Tube Assembly

- Bolt throw – 1"
- Backset – 2-3/8" OR 2-3/4"
- Faceplate – brass 1" x 2 1/4"
- Reversible for either door hand
- Tube – steel. fits 1" diameter bore.

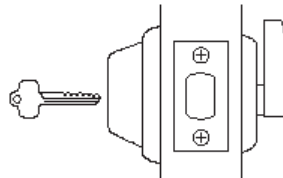

Deadbolt operated by...

- Turning the key in the outside cylinder, OR
- Turning the inside turn lever.

HA-T660-26D-I/C-CONCEALED

GRADE 1 I/C DEADBOLT C/W CONCEALED MOUNTING

HA-T660-26D-I/C

GRADE 1 I/C DEADBOLT STANDARD MOUNTING

HA-T6000-26D-BOLT-2-3/8

BOLT ONLY FOR T660 (2-3/8" BACKSET)

HA-T6050-26D-BOLT-2-3/4

BOLT ONLY FOR T660 (2-3/4" BACKSET)

GRADE 2 COMMERCIAL LEVER LOCKSETS

HALSCO Cylindrical Grade 2 Commercial Lever Locksets are designed for use in situations where durability is the deciding factor. Our cylindrical lock chassis are all constructed with cast retractors on bronze roller bearings. This strong, durable component gives our cylindrical sets the ability to last millions of cycles. This ANSI Grade 2 Commercial cylindrical lever lockset features a lever lock with large, long-lasting lever springs, a standard Halsco latch, and removable through-posts for optional mounting. It is available in 6-pin C keyway and in five basic functions all in a 626 finish. Available in 2-3/4" backset 2-3/8" available.

**Ideally Suited For:
Offices, Apartment buildings,
Warehouse and Manufacturing Facilities.**



FEATURES

- UL / cUL Listed
- ADA Compliant
- For 1 3/8" - 2" thick door
- Optional removable thru-bolts
- ANSI strike standard
- 6 pin "C" keyway cylinder standard
- 1/2" throw deadlatch
- 2 3/4" backset (2 3/8" avail.)
- Satin chrome finish
- Non-handed



AR



AL

HA-AR10-626	PASSAGE	HA-AL10-626	PASSAGE
HA-AR10-605	PASSAGE	HA-AL40-626	PRIVACY
HA-AR40-626	PRIVACY	HA-AL53-626	ENTRANCE
HA-AR40-605	PRIVACY	HA-AL53-626-CLUTCH	ENTRANCE
HA-AR53-626	ENTRANCE	HA-AL53-626-I/C	ENTRANCE
HA-AR53-605	ENTRANCE	HA-AL70-626	CLASSROOM
HA-AR70-626	CLASSROOM	HA-AL70-626-CLUTCH	CLASSROOM
HA-AR70-605	CLASSROOM	HA-AL70-626-I/C	CLASSROOM
HA-AR80-626	STOREROOM	HA-AL80-626	STOREROOM
HA-AR80-605	STOREROOM	HA-AL80-626-CLUTCH	STOREROOM
		HA-AL80-626-I/C	STOREROOM

HA-AL/AR-234-SPRINGLATCH	SPRINGLATCH FOR AL/AR (2-3/4 BACKSET)
HA-AL/AR-238-DL	DEADLATCH ONLY (2-3/8 BACKSET)
HA-AL/AR-238-SPRINGLATCH	AL/AR/ML LOCK SPRINGLATCH (2-3/8 BACKSET)

GRADE 2 COMMERCIAL KNOB LOCKSETS

FEATURES

- UL / ULC Listed - 3 Hour Fire Rating
- For 1 3/8" - 1 3/4" Thick Door
- Accepts most manufacturers cylinders
- 6 pin "C" Keyway Cylinder Standard
- Fits ANSI 115.2 (160 and 161) door prep
- 1/2" Throw Deadlatch
- 2 3/4" Backset (2 3/8" avail.)
- 3" Rose diameter
- Non-Handed
- ANSI Strike Standard

HALSCO Cylindrical Grade 2 Commercial Knob Locksets are designed for use in medium to high traffic situations where durability is the deciding factor. This ANSI Grade 2 Commercial cylindrical Knob lockset features a Heavy Duty Halsco Deadlatch. Available in 6-pin C keyway and in five functions all in a (630) stainless steel and (605) polished brass finish.

Available in 2-3/4" backset 2-3/8" available.

Ideally Suited For:
Offices, Apartment buildings,
Warehouse and Manufacturing Facilities.



HA-10SS	GRADE 2 PASSAGE LOCKSET (STAINLESS STEEL)
HA-10PB	GRADE 2 PASSAGE LOCKSET (POLISHED BRASS)
HA-40SS	GRADE 2 PRIVACY LOCKSET (STAINLESS STEEL)
HA-40PB	GRADE 2 PRIVACY LOCKSET (POLISHED BRASS)
HA-53SS	GRADE 2 ENTRANCE LOCKSET (STAINLESS STEEL)
HA-53SS-2-3/8-BACKSET	GRADE 2 ENTRANCE LOCKSET (2-3/8 BACKSET)
HA-53SS-LC-IC	GRADE 2 ENTRANCE LOCKSET FOR I/C CORE (SFIC)
HA-53SSLC	GRADE 2 ENTRANCE LOCKSET (LESS CYLINDER)
HA-53PB	GRADE 2 ENTRANCE LOCKSET (POLISHED BRASS)
HA-70SS	GRADE 2 CLASSROOM LOCKSET (STAINLESS STEEL)
HA-70SS-LC-IC	GRADE 2 CLASSROOM LOCKSET FOR I/C CORE (SFIC)
HA-70SSLC	GRADE 2 CLASSROOM LOCKSET (LESS CYLINDER)
HA-70PB	GRADE 2 CLASSROOM LOCKSET (POLISHED BRASS)
HA-80SS	GRADE 2 STOREROOM LOCKSET (STAINLESS STEEL)
HA-80SS-2-3/8-BACKSET	GRADE 2 STOREROOM LOCKSET (2-3/8 BACKSET)
HA-80SS-LC-IC	GRADE 2 STOREROOM LOCKSET (FOR I/C CORE)
HA-80SSLC	GRADE 2 STOREROOM LOCKSET (LESS CYLINDER)
HA-80PB	GRADE 2 STOREROOM LOCKSET (POLISHED BRASS)
HA-82SS	GRADE 2 DOUBLE CYLINDER STOREROOM LOCKSET
HA-234	GRADE 2 PASSAGE LATCH, 2-3/4 BACKSET
HA-234DL	GRADE 2 DEADLATCH, 2-3/4 BACKSET
HA-238	GRADE 2 PASSAGE LATCH, 2-3/8 BACKSET
HA-238DL	GRADE 2 DEADLATCH, 2-3/8 BACKSET

GRADE 2 COMMERCIAL T-SERIES LOCKSETS

FEATURES

- **UL / ULC Listed - 3 Hour Fire Rating**
- **For 1 3/8" - 1 3/4" Thick Door**
- **Accepts most manufacturers cylinders**
- **6 pin "C" Keyway Cylinder Standard**
- **Fits ANSI 115.2 (160 and 161) door prep**
- **1/2" Throw Deadlatch**
- **2 3/4" Backset (2 3/8" avail.)**
- **3" Rose diameter**
- **Non-Handed**
- **ANSI Strike Standard**

HALSCO Cylindrical Grade 2 Commercial Knob Locksets are designed for use in medium to high traffic situations where durability is the deciding factor. This ANSI Grade 2 Commercial cylindrical Knob lockset features a Heavy Duty Halsco Deadlatch. Available in 6-pin C keyway and in five functions all in a (630) stainless steel and (605) polished brass finish. Available in 2-3/4" backset 2-3/8" available.

Ideally Suited For:
Offices, Apartment buildings,
Warehouse and Manufacturing Facilities.



HA-T10-32D	GRADE 2 PASSAGE LOCKSET (STAINLESS STEEL)
HA-T10-US3	GRADE 2 PASSAGE LOCKSET (POLISHED BRASS)
HA-T40-32D	GRADE 2 PRIVACY LOCKSET (STAINLESS STEEL)
HA-T40-US3	GRADE 2 PRIVACY LOCKSET (POLISHED BRASS)
HA-T53-32D	GRADE 2 ENTRANCE LOCKSET (STAINLESS STEEL)
HA-T53-US3	GRADE 2 ENTRANCE LOCKSET (POLISHED BRASS)
HA-T70-32D	GRADE 2 CLASSROOM LOCKSET (STAINLESS STEEL)
HA-T70-US3	GRADE 2 CLASSROOM LOCKSET (POLISHED BRASS)
HA-T80-32D	GRADE 2 STOREROOM LOCKSET (STAINLESS STEEL)
HA-T80-US3	GRADE 2 STOREROOM LOCKSET (POLISHED BRASS)
HA-T234-DL-32D	2-3/4" DEADLATCH ONLY FOR T SERIES
HA-T238-32D	2-3/8" SPRINGLATCH FOR T SERIES FOR T10 FUNCTION
HA-T238-DL-32D	2-3/8" DEADLATCH FOR T SERIES FOR 53/70/80 FUNCTION
HA-T41-005	T-SERIES 5" BACKSET LINK T10/40/53/70/80

GRADE 2 COMMERCIAL SERIES DEADBOLT

Heavy Duty Tubular
Single & Double Cylinder Deadbolts

- 3 Hour UL Fire Rating
- ANSI Grade 2

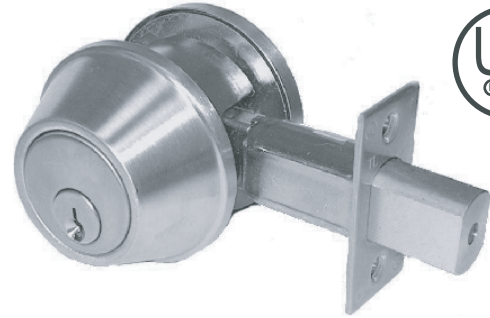

FEATURES

- Schlage "C" keyway
- Standard 2 3/4" backset
- Solid brass 6-pin cylinder
- For 1 3/8" to 1 3/4" thick doors
- 2 1/8" cross bore
- 1" edge bore and 1"x2 1/4" edge preparation
- Solid brass bolt with reinforced hardened steel roller
- Bolt has a 1" throw
- Hardened steel insert (1 7/8" Dia.)

- | | |
|----------------------|----------------------------------|
| HA-T460-32D-SC-2-3/8 | SINGLE CYLINDER, 2-3/8" BACKSET |
| HA-T460-32D-SC | SINGLE CYLINDER, STAINLESS STEEL |
| HA-T460-US3-SC | SINGLE CYLINDER, BRASS |
| HA-T462-32D-SC | DOUBLE CYLINDER, STAINLESS STEEL |
| HA-T462-US3-SC | DOUBLE CYLINDER, BRASS |
| HA-T4000-32D | BOLT ONLY 2-3/8" BACKSET |
| HA-T4050-32D | BOLT ONLY 2-3/4" BACKSET |
| HA-T4050-US3 | BOLT ONLY 2-3/4" BACKSET - BRASS |



GRADE 3 RESIDENTIAL LOCKSETS

- | | |
|------------|----------|
| HA-11505PB | PASSAGE |
| HA-11526SS | PASSAGE |
| HA-11509AB | PASSAGE |
| HA-13505PB | PRIVACY |
| HA-13526SS | PRIVACY |
| HA-13509AB | PRIVACY |
| HA-15505PB | ENTRANCE |
| HA-15526SS | ENTRANCE |
| HA-15509AB | ENTRANCE |

- | | |
|----------|----------|
| HA-11926 | PASSAGE |
| HA-13926 | PRIVACY |
| HA-15926 | ENTRANCE |

SINGLE CYLINDER

- | | |
|------------|-----------------|
| HA-54005 | BRASS |
| HA-54009AB | ANTIQUE BRASS |
| HA-54030 | STAINLESS STEEL |

DOUBLE CYLINDER

- | | |
|------------|-----------------|
| HA-53005 | BRASS |
| HA-53009AB | ANTIQUE BRASS |
| HA-53030 | STAINLESS STEEL |



- | | | |
|--------------------|--------------------|--------------------|
| HA-1700-605 | HA-1700-609 | HA-1700-621 |
| (POLISHED BRASS) | (ANTIQUE BRASS) | (ANTIQUE NICKEL) |

FEATURES

- LIFETIME FINISH
- GRADE 3 RESIDENTIAL
- 3 DIFFERENT FINISHES AVAILABLE



- ORBIT INSIDE KNOB
- ADJUSTABLE BACKSET
- COMES WITH 4 KEYS
- WEISER KEYWAY

- | | |
|--|---|
| HA-1800-605
(PVD - POLISHED BRASS) | HA-1780-605
SPRING LATCH
FOR HA-1700-605/
HA-1800-605 |
| HA-1800-609
(ANTIQUE BRASS) | |
| HA-1800-621
(ANTIQUE NICKEL) | HA-1770
ACTUATOR
MECHANISM
FOR HA-1700/
HA-1800 |
| HA-1800-613
(OIL RUBBED BRONZE) | |



GRADE 3 RESIDENTIAL LEVER SETS

HA-L11509	PASSAGE SET, ANTIQUE BRASS
HA-L11509UL-BOX	PASSAGE SET, ANTIQUE BRASS
HA-L13509-BOX	PRIVACY SET, ANTIQUE BRASS
HA-L13509	PRIVACY SET, ANTIQUE BRASS
HA-L15509	ENTRANCE SET, ANTIQUE BRASS
HA-L11505	PASSAGE, BRASS
HA-L11505UL-BOX	PASSAGE SET, BRASS
HA-L13505-BOX	PRIVACY SET, BRASS
HA-L13505	PRIVACY SET, BRASS
HA-L15505	ENTRANCE SET, BRASS
HA-L11526	PASSAGE, SATIN CHROME
HA-L11526UL-BOX	PASSAGE SET, SATIN CHROME
HA-L13526-BOX	PRIVACY SET, SATIN CHROME
HA-L13526	PRIVACY SET, SATIN CHROME
HA-L15526	ENTRANCE SET, SATIN CHROME
HA-15000	2-3/8 - 2-3/4 SPRING LATCH - GRADE 3



FEATURES

- UL / cUL 20 minute fire-cup
- UL / cUL 1-1/2 Hour Fire-rated latch
- Stainless steel latch
- Adjustable 2-3/4" - 2-3/8" backset
- Non-Handed
- Heavy springs for strong lever return
- 3 Finishes available



GRADE 2 RESIDENTIAL DEADBOLTS

HALSCO B160-Series Deadbolts are adjustable for 2-3/8" (60 mm) or 2-3/4" (70 mm) backsets and also features a 1" (25 mm) throw, with a concealed hardened steel roller to prevent cutting or sawing the bolt. The 1" (25 mm) reinforced trim ring rotates to protect against wrenching the cylinder. Solid brass 6 pin cylinder keyed-different C (1145) keyway for added protection and durability. The Solid steel door frame reinforcer with 3" screws helps protect against kick-in attack.

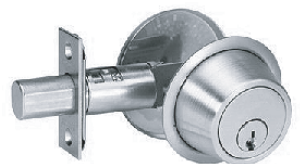

SINGLE CYL. DEADBOLT, 1145 KEYWAY

HA-B160-S-US26D	SATIN CHROME
HA-B160-S-US3	POLISHED BRASS
HA-B160-S-US5	ANTIQUÉ BRASS

SINGLE CYL. DEADBOLT, WR5 KEYWAY

HA-B160-W-US26D	SATIN CHROME
HA-B160-W-US3	POLISHED BRASS
HA-B160-W-US5	ANTIQUÉ BRASS

DOUBLE CYL. DEADBOLT, 1145 KEYWAY

HA-B162-S-US26D	SATIN CHROME
HA-B162-S-US3	POLISHED BRASS
HA-B162-S-US5	ANTIQUÉ BRASS

DOUBLE CYL. DEADBOLT, WR5 KEYWAY

HA-B162-W-US26D	SATIN CHROME
HA-B162-W-US3	POLISHED BRASS
HA-B162-W-US5	ANTIQUÉ BRASS

HA-12-268-US26D	BOLT ONLY FOR B160
HA-12-268-US3	BOLT ONLY FOR B160

COMMERCIAL DOOR CLOSER

FEATURES

- U.L. Listed
- Adjustable From 2 - 5
- ADA (HANDICAP) Adjustable Opening Force
- 3 Valve Adjustment
- Back Check
- Non-Handed
- Parallel Arm Bracket
- Full Cover
- Aluminum & Durodonic Finish
- Closing Speed
- Latching Speed



HA-P1250-AL-HOLD-OPEN (SIZED 2 TO 5)(HOLD OPEN)
HA-P1250-AL (SIZED 2 TO 5)(ALUMINUM)
HA-P1250-DU (SIZED 2-5)(DURODONIC)

Packaging: 1 per box, 10 per case.

HA-600COVER-AL

OVER FOR P1250 & 600 SERIES CLOSER

INDUSTRIAL DOOR CLOSER

Multi-Size Full Featured Closer

- UL Listed
- Adjustable From 1 to 6

FEATURES- ANSI A156.4 GRADE 1

- "UL" Listed
- ADA (HANDICAP) Adjustable Opening Force
- Manufactured Under "ISO 9001" Guideline
- Aluminum & Durodonic Finish
- Delayed action available
- Parallel Arm Bracket



FUNCTIONS

- Tri-Style Installation: Installs Regular, Parallel Arm Or Top Jamb
- Reversible
- Adjustable Sweep And Latch Speed: Separate Valves To Adjust Each Speed And Back Check
- Adjustable Delayed Action Closing Option: "DA"
- Door Opening: Regular 120 degree, Parallel Arm 180 degree. And Top Jamb 120 degree.

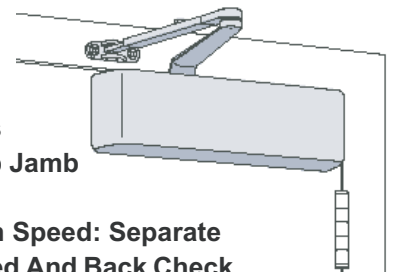

HA-NK4041-AL

HA-NK4041-DU

HA-NK4041-DA-AL

HA-NK4041-HO-AL

HEAVY DUTY DOOR CLOSER (SIZED 1-6/ALUMINUM)
HEAVY DUTY DOOR CLOSER (SIZED 1-6/DURODONIC)
HEAVY DUTY DOOR CLOSER (DELAYED ACTION)
HEAVY DUTY DOOR CLOSER (HOLD OPEN)

HA-NK4040-3077-689

COMPLETE ARM/SHOE ONLY FOR HA-NK4041-689

ADJUSTABLE POWER 900 SERIES DOOR CLOSER

FEATURES

- Non-handed
- UL / cUL Listed
- Meets ADA requirements
- Adjustable power range 2 thru 6
- Factory preset to size 3
- Adjustable arm bracket
- Maximum 180 degree opening
- Cast aluminum housing
- Rack and pinion mechanism
- Non freezing hydraulic fluid
- Adjustable sweep and latching speed valves
- Comes ready for regular, parallel arm and top jamb installation
- Adjustable back check control from 70 - 85 degrees
- Complies with ANSI A156.4 Grade 1
- Finishes : Aluminum and Durodonic

HA-900BC-AL SLIMLINE DOOR CLOSER WITH ALUMINUM COVER (BACKCHECK)

HA-900BC-DU SLIMLINE DOOR CLOSER WITH DURODONIC COVER (BACKCHECK)





RESIDENTIAL DOOR CLOSERS



FEATURES

- SIZE 1 THRU 5 AVAILABLE
- U.L. LISTED
- NON-HANDED
- ALUMINUM & DURO FINISH
- SURFACE MOUNTED

HA-601-AL	SIZE 1
HA-602-AL	SIZE 2
HA-603-AL	SIZE 3
HA-603-DU	SIZE 3
HA-604-AL	SIZE 4
HA-604-DU	SIZE 4
HA-605-AL	SIZE 5

HA-600COVER-AL OVER FOR P1250 & 600 SERIES CLOSER

COMMERCIAL GRADE 2 RIM EXIT DEVICES

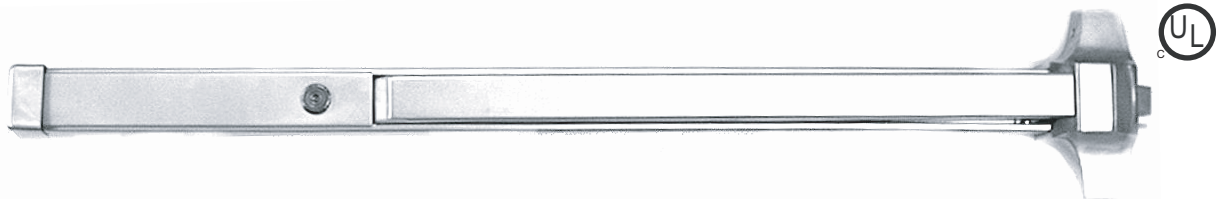

HA-27620-630

U.L. LISTED RIM EXIT DEVICE IN STAINLESS STEEL

FEATURES

- U.L. LISTED
- Painted aluminum finish
- 36" In length
- Non handed / Reversible
- Hex key dogging

- Strike shim included
- Blank filler plate for cylindrical latch cut out
- Orbit outside knob & Lever available
- Complete installation instructions included



HA-27620

GRADE 2 RIM EXIT DEVICE (UL)(ALUMINUM)

HA-27620-FIRE RATED

GRADE 2 RIM EXIT DEVICE (UL)(FIRE RATED)

HA-G27110

HALSCO KNOB TRIM FOR HA-27620 (PASSAGE FUNCTION)

HA-G27132

HALSCO KNOB TRIM FOR HA-27620 (CLASSROOM FUNCTION)

HA-G27135

HALSCO KNOB TRIM FOR HA-27620 (STOREROOM FUNCTION)

HA-G27160

HALSCO KEY IN LEVER FOR HA-27620 (PASSAGE FUNC.)

HA-G27140

HALSCO KEY IN LEVER FOR HA-27620 (CLASSROOM FUNC.)

HA-G27150

HALSCO KEY IN LEVER FOR HA-27620 (STOREROOM FUNC.)



COMMERCIAL GRADE 3 RIM EXIT DEVICES

FEATURES

- STAINLESS STEEL
- 33" IN LENGTH
- NON HANDED
- HEX KEY DOGGING

HA-8200-SS HALSCO EXIT DEVICE, 2-3/4 BACKSET, STAINLESS STEEL



SWINGBOLT DOOR LOCKS



Laminated stainless steel swinging bolt
Non-handed
Faceplate not included

HA-100-118 1-1/8"
HA-100-31/32 31/32"

DEADLATCHES



Zinc plated steel construction
Non-handed
5/8" latch throw
Faceplate included

HA-39-7/8-628 7/8"
HA-39-118-628 1-1/8"
HA-39-31/32-628 31/32"

PADDLES



Zinc alloy base
Non-handed
3" center to center mounting
Cam disc included

HA-4590AL-LH LEFT HAND - ALUMINUM
HA-4590AL-RH RIGHT HAND - ALUMINUM
HA-4590DU-LH LEFT HAND - DURO
HA-4590DU-RH RIGHT HAND - DURO

LEVERS HANDLES



Aluminum construction
Field reversible
Disc cam included

HA-4560-LH LEFT HAND
HA-4560-RH RIGHT HAND

MAC20 STOREFRONT HINGES



For flush mounted doors up to 300 lbs.
Non-handed
Top and bottom hinge incl.
Surface mounted

HA-20AL ALUMINUM HINGE KIT
HA-30DU DURONODIC HINGE KIT

CYLINDER GUARD



Made of Aluminum
Precision cut
Non-handed

HA-M1 CYLINDER GUARD (1 INCH CYLINDER)

FLUSH BOLTS



H33



DC860



11010

HA-H33-26D STEEL DOORS, 12" ROD, 4 HOLE, UL LISTED
HA-11010-C3 WOOD DOOR FLUSH BOLT (6 X 3/4)
HA-DC860-AL 2 HOLE RECESSED FLUSH BOLT (ALUMINUM)
HA-DC860-DURO 2 HOLE RECESSED FLUSH BOLT (DURONODIC)

SECRET GATE LATCH



HA-H600BP BRASS PLATED

8" HEAVY DUTY SURFACE BOLTS



HA-20750-POLISHED BRASS
HA-20750-SATIN CHROME (UL)

RUBBER DOOR SILENCERS



HA-64 DOOR SILENCER (100/BAG)

The COMBI-CAM

Functions on doors or drawers
Ideal for locker applications, desks, banks, keykabs, etc..
Maximum material thickness: 1-1/8"
Fits standard 3/4" cam hole



Item	Cylinder Length	Finish
HA-7850S	5/8"	US26D
HA-7850M	7/8"	US26D
HA-7850L	1-1/8"	US26D

MORTISE CYLINDER HARDENED STEEL GUARD RING



HA-CG3-26D
HA-CG3-AMB

NUMBER AND LETTER STAMPING SETS



- HA-01091 FIGURE DIE SET (1/16 INCH)
- HA-01271 LETTER DIE SET (1/16 INCH)
- HA-02091 FIGURE DIE SET (3/32 INCH)
- HA-02271 LETTER DIE SET (3/32 INCH)
- HA-03091 FIGURE DIE SET (1/8 INCH)
- HA-03271 LETTER DIE SET (1/8 INCH)

INSULATED, SPRING LOADED MAIL SLOT



- HA-442-31 ALUMINUM FLAP / BLACK FRAME
- HA-442-33 BRASS FLAP / BLACK FRAME

MAILBOX LOCKS

CMC MAILBOX LOCK WITH ASSORTED CAMS



HA-3950

OLD STYLE MAILBOX LOCK



HA-919

METAL ROSSEAU MAILBOX LOCK



HA-D49SE

METAL ROSSEAU MAILBOX LOCK LATCH



HA-D49K

RIOPEL MAILBOX LOCK



HA-3950



MAILMAN'S DOOR OPENER

Permits locking of street entrance doors for apartment buildings, maintaining strict security and control, but allowing authorized postal employees to enter the building to distribute mail in accordance with the Post Office regulations.

The door opener is designed to house the Post Office lock - which lock is furnished and installed by the Post Office.

HA-R115 HALSCO MAILMAN'S DOOR OPENER WITH MICRO SWITCH

JIMMY PROOF
WEISER KEYWAY



HA-1637 SINGLE CYL.
HA-1738 DOUBLE CYL.

NIGHT LATCH
WITH WEISER
KEYWAY



HA-738A

BRASS SECURITY
CHAIN WITH
KEY LOCK



HA-99

200 DEGREE
BRASS DOOR
VIEWER



HA-20605
HA-20626

160 DEG/ UL LISTED
BRASS DOOR
VIEWER



HA-2073-605

BRASS PLATED
REPLACEMENT
KNOBS



HA-18

SOLID BRASS
REPLACEMENT
KNOBS



HA-197

PATIO DOOR
PIN



HA-309

REPLACEMENT
RIM CYLINDER
WEISER KEYWAY



HA-738C
HA-738C-KA

LOCKING T-HANDLE
KEYED DIFFERENT
1.5" CENTERS



HA-69

3" BARREL
BOLT



HA-25630 CHROME
HA-25530 BRASS

4" PADBOLT
WITH MOUNTING
SCREWS



HA-2064 4"
HA-2066 6"

HEAVY DUTY
PADBOLT



HA-2069 5"
HA-2070 8"

4.5" & 3"
HASP LOCK

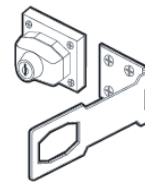

HA-103 3"
HA-145 4.5"
HA-145KA

SHOW CASE
LOCK



HA-247
HA-247KA-532

4 3/4" KICK DOWN
DOOR HOLDER

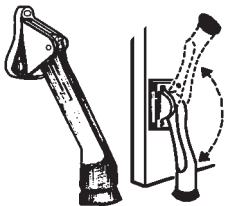

HA-165-605
HA-165-626

30.5" WIND
CHECK CHAIN



HA-3560

BRASS SECURITY
CHAIN



HA-66

SOLID BRASS
ADJUSTABLE
BALL CATCH



HA-12400-C15
HA-12400-C3

THUMBTURN MORTISE
CYLINDER WITH
RED DOT



HA-101TK

SECURITY KEYCLIP
(24 CLIPS PER CARD)



HA-1220

PULL APART
KEY RINGS



HA-1818

KEY IDENTIFIERS
6 COLOURS/200 PER BOX



HA-1KRA

KEY TAGS WITH WINDOW
6 COLOURS/200 PER BOX

HA-PT1A-ASST



(SOLD IN MULTIPLES OF 100)
 HA-PT1-BLACK KEY TAG
 HA-PT1-BLUE KEY TAG
 HA-PT1-GREEN KEY TAG
 HA-PT1-RED KEY TAG
 HA-PT1-WHITE KEY TAG
 HA-PT1-YELLOW KEY TAG

TOOLS

THE HINGE DOCTOR



The Hinge Doctor is the time saving, hinge restoration tool you have been looking for. Sagging doors repaired in seconds! We are very serious here. You need to see and use it to believe it.

HA-HA1 Commercial, for 4 1/2" standard weight hinges

HA-HA3 Institutional, Prison, and spring hinges

THE SQUEEZE PLAY



The Squeeze-Play Hollow Metal Door Mortiser tool creates a square mortise in a hollow metal steel door, to accept

HA-SQUEEZEPLAY standard square face lock or latch bolts. The standard mortise will accept a 2 1/4" x 1" or 2 1/4" x 1 1/8" square face bolt. Simply drill the holes, install the tool and tighten the bolt. Squeeze Play forms the edge of the door, creating the square mortise. There is no cutting or need for internal door bridges. Leaves a professional mortise to accept the bolt. Installation is fast, easy, and requires no additional parts.

BICYCLE LOCKS



HA-BL101C
32" CABLE
BIKE LOCK



HA-BL116A
30" CABLE
BIKE LOCK



HA-BL118
32" CABLE
BIKE LOCK



HA-BL117
72" CABLE
BIKE LOCK

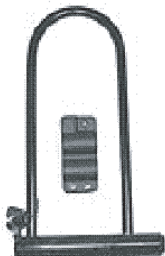

HA-BL112D
"U" BAR
BIKE LOCK



HA-BL123
72" CABLE BIKE
LOCK WITH
PADLOCK



HA-BL126
30" CABLE
BIKE LOCK



HA-BL133
32" CABLE
BIKE LOCK

BIKE LOCK KEYBLANKS

HA-KB116 / BL116,117,118

HA-KB126 / BL126

HA-KB128 / BL112D

HA-KB136 / BL101C

ELECTRONIC GUN

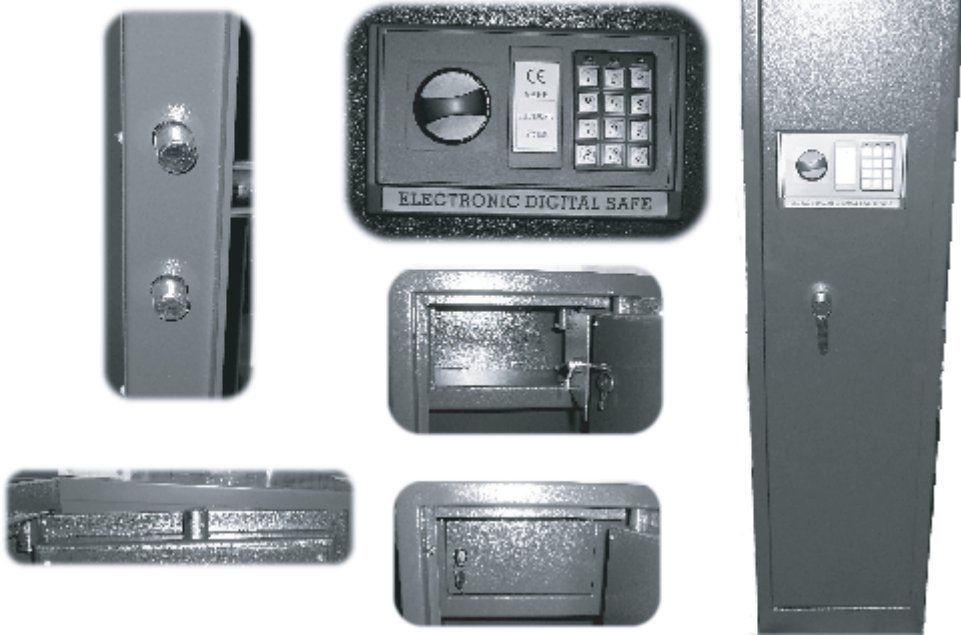

HA-427-400

Features

- With electronic lock which is simple to operate and can be programmed with any 3 to 8 digit code
- 4 Bolts - 1 Top, 1 Bottom and 2 on the opening side
- Manual override key system
- Pre-Drilled inside the safe with mounting bolts
- Powder coated interior and exterior finish
- Holds 5 Guns
- External dimensions H-57" D-12" W-13 3/4"
- Interior dimensions H-56 3/4" D-9" W-13 1/2"
- Approximate weight: 59 kgs (129 LBS)
- Requires 4 x "AA" size (1.5V) Batteries

HA-427-200



HA-427-260



HA-427-220

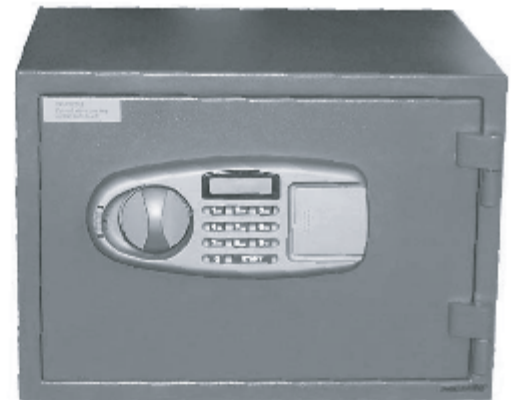

FIRE SAFE

FEATURES

- SIMPLE TO OPERATE AND CAN BE PROGRAMMED WITH ANY COMBINATION OF 3 TO 8 DIGITS
- SECURITY AND POWER STATUS SHOWN BY A SERIES OF LED DISPLAY AND BUZZER FEEDBACK FOR EACH OPERATION- MANUAL OVERRIDE KEY SYSTEM
- CONSTRUCTED OF SOLID STEEL
- PRE-DRILLED INSIDE THE SAFE WITH FIXING BOLTS ALLOWING PERMANENT MOUNTING TO ANY SURFACE
- EXTERNAL DIMENSIONS: D-14" X W-10" X H-10"
- APPROXIMATE WEIGHT : 11.5kgs
- REQUIRES 4 X "AA" SIZE (1.5V) BATTERIES

FEATURES

- SIMPLE TO PROGRAM
- CAN USE MOST TYPES OF SWIPE CARDS
- SECURITY AND POWER STATUS SHOWN BY A SERIES OF LED DISPLAY FEEDBACK FOR EACH OPERATION
- MANUAL OVERRIDE KEY SYSTEM
- CONSTRUCTED OF SOLID STEEL
- PRE-DRILLED INSIDE THE SAFE WITH FIXING BOLTS ALLOWING PERMANENT MOUNTING TO ANY SURFACE
- EXTERNAL DIMENSIONS: D-14" X W-10" X H-10"
- APPROXIMATE WEIGHT : 11.5kgs
- REQUIRES 4 X "AA" SIZE (1.5V) BATTERIES

FEATURES

- **1 HOUR FIRE RATING**
- SIMPLE TO OPERATE AND CAN BE PROGRAMMED WITH ANY COMBINATION OF 3 TO 8 DIGITS
- POWDER COATED INTERIOR AND EXTERIOR
- MANUAL OVERRIDE KEY SYSTEM
- CONSTRUCTED OF SOLID STEEL
- VISUAL LOW BATTERY WARNING
- EXTERNAL DIMENSIONS: D-14" X W-16.5" X H-12"
- INTERIOR DIMENSIONS: D-8.75" X W-12" X H-7"
- APPROXIMATE WEIGHT : 29kgs
- REQUIRES 4 X "AA" SIZE (1.5V) BATTERIES

ELECTRIC STRIKES

The 1006 Series is the strongest and most versatile electric strike available. It meets or exceeds every standard developed for electric strikes. With 27 faceplate options, the 1006 can accommodate virtually every type of lockset on the market. The 1006 features an innovative dual interlocking plunger design and heavy-duty, all stainless steel construction. Tested to exceed 3,000 lbs. of static strength, 350 ft-lbs. of dynamic strength and factory tested to exceed 1,000,000 cycles of operation; the 1006 is in a class of its own.



The strongest and most versatile electric strike available.



Specifications

- UL 10C, 3 hour fire-rated (fail secure only)
- ANSI A250.13-2003 windstorm listed
- UL 1034, burglary-resistant listed
- ANSI/BHMA 156.31, Grade 1
- NFPA-252 fire door conformant
- ASTM-E152 fire door conformant
- MEA New York City accepted
- Florida Building Code approved
- Patented design
- Frame application:
- Steel • Aluminum • Wood

ALL STRIKES ARE 12/24VDC, STAINLESS STEEL

HE-1006-630	FAIL SECURE
HE-1006-LBM-630	LATCH BOLT MONITORING
HE-1006-F-630-12/24VDC	FAIL SAFE

AVAILABLE FACE PLATES

HE-1003-E-OPTION-630	(ANSI) FOR DEADBOLT
HE-1003-J-2-OPTION-630	CYLINDRICAL LOCKS (3/4" THROW)
HE-1003-J-OPTION-630	(ANSI)
HE-1003-KD-OPTION-630	FOR SCHLAGE, SARGENT, YALE LOCK
HE-1003-KM-OPTION-630	FOR SARGENT 8200 SERIES MORTISE LOCK

The 5000 Series is a compact, high performance electric strike designed for low profile openings where there is limited space behind the jamb. This includes narrow style aluminum jambs and jambs with protruding glass inside. The field selectable fail secure/fail safe unit is easy to install and accommodates 5/8" latchbolts.



Grade 1, low profile solution

HE-5000-12/24VDC



Specifications

- UL 1034, burglary-resistant listed
- ANSI/BHMA 156.31, Grade 1
- MEA New York City accepted
- Patented design
- Frame application:
- Steel • Aluminum • Wood

AVAILABLE FACE PLATES

HE-501-OPTION-630	ANSI
HE-502-OPTION-630	7-15/16"
HE-503-OPTION-630	6-7/8 X 1-1/4"
HE-503B-OPTION-628	6-7/8 X 1-1/4" BEVELED

ELECTRIC STRIKES**The 4500 Series**

is the first electric strike designed for installation in 2" UL 10C fire-rated frames with ½" drywall penetration. Based on the design of the popular 5000 series, the 4500 electric strike features a low profile 1-3/8" depth, heavy-duty cast stainless steel construction and horizontal adjustment for simple installation. Its strength is derived from a unique keeper pin locking design, enabling the 4500 to exceed the ratings of the frame, door and locking hardware. Designed for use with cylindrical and mortise locksets up to a 3/4" throw.



The versatile, low profile, heavy duty, fire-rated solution



Fire rated

UL 1034
burglary ratedField selectable
(12 or 24VDC)

Grade 1

Cylindrical
locksetsMortise locks
without deadbolts**ALL STRIKES ARE 12/24VDC, STAINLESS STEEL**

HE-4500-630-12/24DC

LOW PROFILE HEAVY DUTY
FIRE-RATED STRIKE**Features**

- Stainless steel construction
- Tamper resistant
- Static strength 3,000 lbs.
- Dynamic strength 70 ft-lbs.
- Endurance 500,000 cycles
- Fail secure (standard)
- Dual voltage 12 or 24 VAC/VDC
- Horizontal adjustment
- Non-handed
- Internally mounted solenoid
- Accommodates up to a 3/4" latchbolt
- Strike body depth 1-3/8"
- Plug-in connector
- Trim enhancer

Specifications

- UL 10C fire rated, 3 hour (fail secure only)
- CAN4-S104 (ULC-S104) fire door conformant
- WHI fire door listed
- UL 1034 burglary-resistant
- ANSI/BHMA 156.31, Grade 1 (#E09321, #E09322, #E09323)
- NFPA-252 fire door conformant
- ASTM-E152 fire door conformant
- California Fire Marshall Listed
- UBC-7-2-94, Uniform Building Code
- Patented design • Frame application:
 - Steel • Aluminum • Wood
 - .24 Amps @ 12VDC
 - .12 Amps @ 24VDC
 - DC Continuous Duty/AC Intermittent Duty

ELECTRIC STRIKES

The 5200 Series raises the standard in adaptability for electric strikes. Offering features such as an all new innovative approach to in-frame horizontal adjustability, the electric strike is the perfect fit for multiple applications. The field selectable fail secure/fail safe unit is easy to install and accommodates 3/4" latchbolts.

Specifications

- Tamper resistant
- Static strength 1,500 lbs.
- Dynamic strength 70 ft-lbs.
- Endurance rating 500,000 cycles
- Field selectable fail secure/fail safe
- Dual Voltage 12 or 24 VAC/VDC
- In-frame horizontal adjustment
- Non-handed
- Internally mounted solenoid
- Accommodates 5/8" - 3/4" latchbolt (with 1/8" door gap)
- Strike body depth 1-3/16"
- Plug-in connector
- Trim enhancer included
- Frame application:
• Steel • Aluminum • Wood



Grade 1, adjustable solution

AVAILABLE FACE PLATES

HE-501-OPTION-630	ANSI
HE-502-OPTION-630	7-15/16"
HE-503-OPTION-630	6-7/8 X 1-1/4"
HE-503B-OPTION-628	6-7/8 X 1-1/4" BEVELED



UL 1034
burglary rated



Field selectable
fail secure/ fail safe



Field selectable
(12 or 24VDC)



Grade 1



Cylindrical
locksets



Specialty
locksets

5200 SERIES ARE 12/24VDC, STAINLESS STEEL

HE-5200-12/24VDC-630

FIELD SELECTABLE STRIKE

The 7000 Series has a modular design to accommodate both cylindrical and rim exit locksets. The 7000 series will accommodate various types of latchbolts from 5/8" to 3/4" throw. The unique design of the keeper module allows the unit to operate under excessive door loading. The 7000 series has an internally mounted solenoid for ease of installation in metal, aluminum and wood jambs. The heavy-duty construction of the 7000 series electric strikes makes them ideal for high usage applications.

Specifications

- Stainless steel construction
- Tamper resistant
- Static strength 1,000 lbs.
- Field selectable fail secure/fail safe
- Accommodates up to 30 lbs. pre-load
- Non-handed
- Internally mounted solenoid
- Strike body depth 1-11/16"
- Plug-in connector
- Frame application:
Steel • Aluminum • Wood

7000 SERIES ARE 12/24VDC, STAINLESS STEEL

HE-7000-12VDC	ELECTRIC STRIKE (12VDC)
HE-7000-24VDC	ELECTRIC STRIKE (24VDC)
HE-701-OPTION-630	FACEPLATE 7000 SERIES (4-7/8 X 1-1/4 ANSI)
HE-783-SMB-BLK	SURFACE MOUNTED BOX (BLACK)
HE-783S-OPTION-628	RIM STRIKE FACEPLATE FOR 7000 SERIES



UL 1034
burglary rated



Field selectable
fail secure/ fail safe



Grade 2



Cylindrical
locksets



Panic Devices

ELECTRIC STRIKES

The 5900 Series offers unmatched performance and reliability. This field selectable fail safe/fail secure unit requires no cutout on the frame for fast, easy installation. It accommodates 1/2-5/8" latchbolts (with 1/8" door gap). With patented vertical adjustability to accommodate door sag or misalignment, the 5900 sets the standard for concealed electric strikes.

Specifications

- No cutting on frame required
- ANSI/BHMA 156.31, Grade 1
- UL Pending
- Patented design
- Vertical adjustability to accommodate door sag
- Tamper resistant
- Field selectable fail safe/fail secure
- .24 Amps @12VDC
- .12 Amps @ 24VDC
- DC Continuous Duty/AC Intermittent Duty
- Non-handed
- Internally mounted solenoid
- Accommodates 1/2-5/8" latchbolts (with 1/8" door gap)
- Strike body depth 1-1/16"
- Plug-in connector
- Frame application:
Steel • Aluminum • Wood



The concealed electric strike solution



Cylindrical locksets



GRADE 1



Field selectable fail secure/ fail safe



Field selectable (12 or 24VDC)

5900 SERIES, NO FRAME CUTTING REQUIRED

HE-5900-12/24VDC NO FRAME CUTTING ELECTRIC STRIKE

AVAILABLE FACE PLATES

HE-591-630	4-7/8" x 1-1/4"	square corner
HE-591A-630	4-7/8" x 1-1/4"	radius corner
HE-592-630	7-15/16" x 1-7/16"	radius corner
HE-593-630	6-7/8" x 1-1/4"	radius corner
HE-595-630	9" x 1-3/8"	radius corner

A standard electric strike requires a cutout on the side of the door frame to allow the extended latchbolt to exit the frame. In contrast, the 5900 is designed to utilize special internal ramps to eject the latchbolt from an unmodified frame. For the 5900 to operate correctly, it is important for you to first understand the relationship between the unit's internal ramps and the position of the latchbolt.

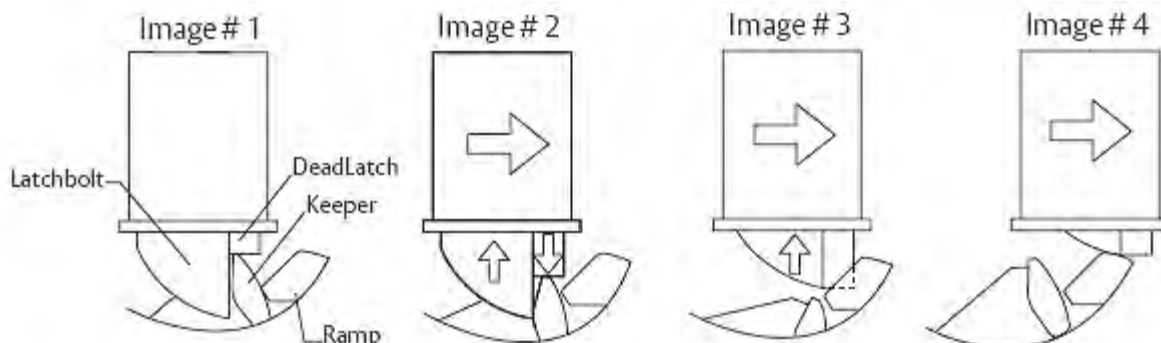

RIM ELECTRIC STRIKES

The 9500 Series Genesis™ is completely surface mounted, featuring all components completely encased within its 3/4" thick stainless steel housing-requiring no cuts to the jamb. Designed for use with 3/4" exit devices, the Genesis series is field selectable to either fail secure or fail safe operation and can be operated with either 12 or 24 Volts DC. The 9500 Genesis™ is the perfect solution for fire-rated rim exit applications.

Specifications

- UL 10C fire-rated, 1-1/2 hr (fail secure only)
- CAN4-S104 (ULC-S104) fire door conformant
- WHI fire door listed
- UL1034 burglary-resistant listed
- ANSI/BHMA 156.31, Grade 1 (#E09371, #E09372)
- NFPA-252 fire door conformant
- ASTM-E152 fire door conformant
- UBC-7-2-94, Uniform Building Code
- Patented design
- Frame application:
• Steel • Wood



The completely surface mounted, Fire rated solution



9500 SERIES ARE ALL STAINLESS STEEL
HE-9500-630-12VDC/24VDC GENESIS RIM ELECTRIC STRIKE (FIRE RATED)

The 9600 Series Genesis™ accommodates rim exit devices in metal or wood jambs. The 9600 features an internally mounted solenoid and two stainless steel, independently-operating locking mechanisms. Its easy to install, with all components encased in the 3/4" thick stainless steel housing, requiring no cuts to the jamb prior to installation.



9600 SERIES ARE ALL STAINLESS STEEL
HE-9600-630-12VDC/24VDC DUAL VOLTAGE
HE-9600-LBSM-630-12/24VDC LATCH BOLT STRIKE MONITOR

Specifications

- Completely surface mounted
- Stainless steel construction
- Tamper resistant
- Static strength 1,500 lbs.
- Dynamic strength 70 ft-lbs.
- Endurance 500,000 cycles
- Field selectable fail safe/fail secure
- Dual voltage 12 or 24 VDC
- Horizontal adjustment
- Non-handed
- Internally mounted solenoid
- Accommodates up to 3/4" pullman latch
- Frame application:
• Steel • Wood

ACCESSORIES

The 2005 SMART Pac II™ is an in-line power control that is able to receive input voltages from 12 to 32V AC or DC. The built-in bridge rectifier provides 12 or 24VDC output. Under continuous duty operation, the output VDC is reduced by 25% to extend the life of the electric strike. The SMART Pac II™ includes an in-line fuse, MOV to protect against possible inrush and reverse surges, and a 2-8 second adjustable timer.

For fool-proof installations

Standard Features

- Accepts wide range of input voltage: 12-32 Volts AC or DC
- Output 12VDC or 24 VDC with inputs of 24 Volts or greater
- Built-in bridge rectifier
- Built-in surge protection / voltage regulation
- Operates in Fail-Secure and Fail-Safe modes
- Activation timer: keeps strike energized for set period of time, adjustable from 2-8 seconds
- Continuous duty timer: reduces initial voltage by 25% after set period of time, adjustable from 2-8 seconds, provides cooler more efficient operation of strike



**HE-2005-SMARTPAC-II
SMARTPAC-II IN-LINE POWER CONTROL**

****Note:** The SMART Pac II™ can not provide an output voltage greater than the input voltage.

The 2001 Rectifier™ Plug in In-line rectifier converts AC to DC at the electric strike, 35V, 1amp.



HE-2001-RECTIFIER PLUG IN BRIDGE RECTIFIER

2002 Transformer 2002-24 Converts 110/120 VAC to 24 VAC output. 20V, 0.8 Amp max.



HE-2002-24 HES TRANSFORMER

ALL DESIGNS AVAILABLE IN 3 POPULAR KEYWAYS

SC1 - SCHLAGE C

KW1 - KWIKSET

WR5 - WEISER



D1



D2



D3



D4



D5



D6



D7



D8



D9



D10



D11



D12



D13



D14



D15



D16



D17



D18



D19



D20



D25



D26



D27



D28

ALL DESIGNS AVAILABLE IN 3 POPULAR KEYWAYS

SC1 - SCHLAGE C

KW1 - KWIKSET

WR5 - WEISER



B1



B2



B3



B4



B5



E1



E2



E3



E4



E5



E6



E7



E8



E9



E10

ALL DESIGNS AVAILABLE IN 3 POPULAR KEYWAYS

SC1 - SCHLAGE C

KW1 - KWIKSET

WR5 - WEISER



D21



D22



D23



D24



G1



G2

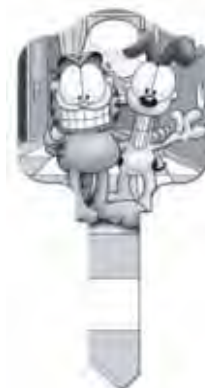

G3



G4



P1



P2



P3



P4



P4

ALL DESIGNS AVAILABLE IN 3 POPULAR KEYWAYS

SC1 - SCHLAGE C

KW1 - KWIKSET

WR5 - WEISER



CODE KEY CUTTING MACHINES

The Blitz™ is HPC's second generation of the 1200CM Code Machine. It works exactly the same as the 1200CM, but has several additional features. Both the depth and spacing shafts have fewer threads per inch, which means that substantially fewer revolutions are needed to achieve the full range of travel. The Blitz™ also features a shoulder gauge with safety cut-off switch. Plus, the Blitz™ Code Machine is equipped with HPC's Softie™ deburring brush with a safety shield.

These machines cut accurate keys by code quickly and easily. The ease of changing from one manufacturer's specifications to another is so simple, it is unparalleled. Even radically different changes can be set up in 10 to 30 seconds without wasting any key blanks

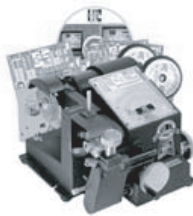

Original Blitz™

Code Milling Key Machine 1200CMB Patent #'s:
4,117,763...4,090,303...4,012,991

"The Standard of the Industry" since 1978. The first choice of locksmiths worldwide! Tens of thousands have been sold and are still in use today! Plus, you get 2 cutters, 150 cards and CodeSource® Lite. (You must register your Blitz™ machine with HPC, Inc. to receive the software.)

HP-1200CMB

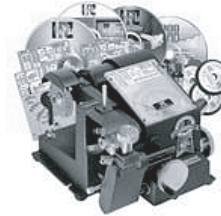

Extreme Blitz™

Perfect for the locksmith who wants it all! Ideal for a new locksmith, a second shop or a new van. Plus, you get 3 cutters, 175 cards, 3 software programs, Tubular Key Adapter and Calibration Kit. (You must register your Blitz™ machine with HPC, Inc. to receive the software.)

HP-1200CMBX

CodeMax® The Original Computerized Code Machine

Put the power of a computer in your code cutting with the CodeMax® Machine (1200MAXAA). Based on the industry standard 1200CM/Blitz™ Machine, the CodeMax® is the original computerized code machine.

CodeMax® has an internal computer chip that contains Depth & Space Data (DSD) for more than 800 different lock types. The machine can accommodate keys with up to 14 spaces and 14 depths, it also has a micrometer function in both inch and metric formats. This versatility allows it to cut virtually all standard vehicle, commercial, residential, and furniture keys throughout the world



HP-1200MAXAA

With optional equipment CodeMax® can cut:

- Assa V10/Twin®
- Emhart Interlocking Pin®
- Medeco Biaxial®, Commercial® & KeyMark®
- Schlage Primus®
- Flat Steel Safe Deposit Box Keys
- Other specialty keys

CUTTERS AND PARTS FOR THE 1200 SERIES

HP-CW-1011	90° SMALL CYLINDER CUTTER	HP-CW-32MC	90° CUTTER WHEEL FOR ASSA TWIN & V-10
HP-CW-14MC	100° STANDARD LARGE CYLINDER CUTTER	HP-CW-1012	MEDECO CUTTER
HP-CW-20FM	76° DOUBLE ANGLE FLAT MILL TOOTH FOR SARGENT	HP-SNK-3	HPC REPLACEMENT WING NUT
HP-CW-80	SILCA CUTTER (SI-CU1)(80-5-16)(FOR REXA I,II,III)	HP-22-01	CUTTER FOR 747 KEY MACHINE (11747-32)
		HP-9160-BELT	BELT FOR 9160 AND 9180

DUPLICATING KEY CUTTING MACHINES

Premier Speedex® Manual Key Duplicator 9160MC

The Premier Speedex® (9160MC) is a manual duplicator, perfect for duplicating even the largest of keys, such as hotel/motel room keys. It is equipped with 4-way jaws for holding a large variety of different blanks, including double sided keys (such as foreign automotive keys). The reversible copy dog allows you to cut flat steel keys with the optional slotting cutter kit (CW-16KIT). The simplicity of operating this machine makes easy work out of duplicating even a large number of keys. The Premier Speedex® is mounted on a sturdy base and comes equipped with a heavy-duty motor. It also comes equipped with the HPC Softie™ de-burring brush. Its durable construction and bronze bearings combine for a long lasting product.



HP-9160MCDC

SOFTWARE

CodeSource®

The Ultimate Code Retrieval Program

Instantly search through millions of codes with the versatile search function. Search by manufacturer, vehicle model, key blank, code card number, or DSD number. All key cutting information is concisely displayed. Easily read the bitting, depth and space dimensions, key blank information, and more. View an image of the cut key before cutting. View DSD and Series specific notes; as well as adding your own notes. Search by bitting or partial bitting. Display, rearrange, and print a cutting tree to minimize the number of key blanks needed. Print code cards for your Blitz™, Punch™, and Pocket Decoder. Download data to your Blue SHARK™ and/or CodeMax®. Keep track of your customers and their keys. Print business cards with this information for your customers to hold onto and keep them coming back to you. Locate applicable code series and key blank comparatives from multiple key blank manufacturers. Edit and add your own information including hook location. Access the latest 15 years of opening information using the proven 13 Methods of Car Opening. Create your own code series and depth & space data records.



HP-CS-CD

MasterKing®

For Development of Superior Master Keying Systems

MasterKing® creates superior master keying systems faster than ever before. Enter some basic information and MasterKing® will generate your systems quickly and easily! MasterKing® eliminates transposed or repeated numbers, as well as uncuttable keys. Manually writing master key systems can be very time consuming and error prone. Use MasterKing® to produce accurate systems in minutes instead of days!



HP-MK-CD

Features of MasterKing®:

- Allows Manipulation of the Key Bitting Array
- Multi-User/Level Password Security
- Modifiable Report Format allows you to print only what you want
- Powerful Database Feature allows you to export your systems in Text, RPT, Dif, ODBC, Tab or Comma Separated, Excel, Lotus or Word Format
- Contains a Database of more than 150 Lock Types from over 50 Manufacturers
- Allows Entry of New Manufacturers through Custom Hardware Feature
- Very Intuitive and Easy to Navigation
- Able to Generate 1 to 5 Levels in List Format
- Displays Change Keys, Block Master, Row Masters, Vertical & Horizontal Grand Masters, Page Masters, Multi-Page Masters and the TMK in Page Format Masters, Page Masters, Multi-Page Masters and the TMK in Page Format
- Supports Cross-Keying
- Supports Total Position Progression and Rotating Constants
- Handles Locks Containing 4, 5, 6, 7, or 8 Chambers
- Computes Driver and Control Pins in Interchangeable Core (IC) Systems
- Allows Manual Entry of Existing Systems
- Allows Customized Progression Sequence
- Allows Entry of Descriptions for Each Bitting
- Automatic Manufacturer Specification Fill-In with Easy Editing Capacity
- Help File and Tutorial
- Search by Bitting, Key Symbol or Description



KeyTrail®

For Complete Management of Keys, Personnel & Locations

KeyTrail® is designed to provide complete management of keys, the people that hold them and the doors they open, all from one screen. A vital aspect of the security at any facility is the ability to instantly determine who has access to specific locations. Whether you are a locksmith managing an apartment complex or the facility manager at a university, KeyTrail® allows you to monitor the entire operation.

Features of Key Trail®:

- Instantly see who has access to a location.
- Easily see which keys have been issued and which keys remain in cabinets or in stock.
- KeyTrail® utilizes "drag & drop" technology to move one item to another.
- For example, to assign a key to an employee, just click on the key and drag it to the employee.
- KeyTrail® is simple to use. You are provided with easy to understand icons, drop down menus, keyboard shortcuts, as well as a comprehensive Help file.
- KeyTrail® has a very flexible security feature. The system administrator can set up an unlimited number of security profiles for other people who will be managing the system. Plus KeyTrail® provides an audit trail that tracks all transactions.
- KeyTrail® generates optional work orders to track cylinder installation and key duplication.

HP-KT-CD



- KeyTrail® supports Interchangeable Core (IC) systems and can interface with HPC's MasterKing® and CodeMax® to make an all encompassing key producing/tracking package.
- Information can be imported or exported in either tab delimited or comma delimited format.
- KeyTrail® can be installed on an individual PC or on a network server.
- Knowledgeable and Friendly Technical Support.
- A large variety of detailed reports is available to provide concise information.
- Network compatible for use in multi-user environments
- Perfect for universities, hospitals, office buildings, factories, institutions, etc.

THE AIR WEDGE® AND AUTO WEDGE



HP-AW-100

Universal Air Wedge®

The new Universal Air Wedge® is four tools in one! It opens cars, installs doors and windows, holds doors, and opens garage doors. Like the Original Air Wedge®, the Universal Air Wedge® is made of a sturdy vinyl and equipped with a bulb pump and release valve for quick and easy inflating and deflating.

Auto Wedge®

The Ultimate Auto Wedges are designed for smooth, safe insertion and will not fall into door cavities. The special angled tips allow for easier insertion and the sure-stop edges stop you from pushing these wedges in too far. These wedges feature a special tapered body that prevents them from popping out, and the special "illumination hole" holds your probe light in place at any angle. Available in two popular sizes, 3/4" (19mm) and 3/8" (9.5mm) maximum thickness.



- The sure-stop edge prevents you from pushing these wedges too far into the door.
- The tapered body stops these wedges from popping out.
- The "illumination-hole" holds your light in place, focused where you need it.
- The special angled ends make these the easiest wedges to slip into doors.

HP-AW-34 AUTO WEDGES 3/4 (2/PKGE)
HP-AW-38 AUTO WEDGES 3/8 (2/PKGE)

Air Wedge®

HPC's Air Wedge® (AW-99) slides between the vehicle door and the weather stripping on the door frame. Then the pump is squeezed, inflating the Air Wedge® and separating the vehicle door from the frame. This provides more than ample room to insert a car opening tool, such as CO-6, CO-78, CO-80, CO-81, CO-82 or CO-83. The Air Wedge® is made of a sturdy vinyl and equipped with a release valve. The Air Wedge® works exceptionally well with the HPC AutoSleeve™ (AS-1).

HP-AW-99



PICK GUNS

Electropick™

HPC's Electropick™ is the original cordless rechargeable electric pick gun. Now with a new ergonomic grip and more comfortable to use. The gun rakes open pin and disc tumbler cylinders using a rapid up and down striking movement, which causes the top and bottom pins to separate, meeting the shear line. The up and down motion is adjustable by a thumbscrew with a locking nut controlling the action after the range of motion is set. The Electropick™ comes complete with a 120VAC or 240VAC charger, 4 pick blades and 2 tension tools. Replacement Pick Blades are available.



HP-EPG-1

PICKS & EXTRACTORS

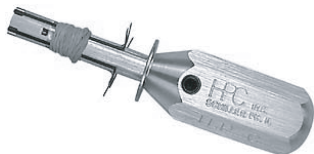

HP-TLP-C

Tubular Pick

The Model B is an upgraded version of the TLP-C. This design permits infinitely variable tension against the feelers. The Model B has an aluminum handle, stainless steel barrel, spring steel feelers and comes in a genuine leather case with the TKPD-1 decoder.

Superior Pick Set

The Superior Pick Set is perfect for the discerning locksmith. It provides a wide selection of picks for a variety of uses. This set contains a variety of full, half, and three quarter rakes and diamond tips; half, single, and double ball picks; light, medium, and heavy weight tension wrenches; and saw type key extractors. It also includes dual pronged tension tools that provide even tension on double-sided wafer locks.



HP-NDPK-32



HP-NDPK

Deluxe Pick Set

The Deluxe Pick Set is perfect for the beginning locksmith. It comes complete with 10 picks, 4 tension tools, and 2 extractors. Each pick is made of a hardened spring steel, tempered to the perfect degree of hardness. It contains a mix of rake, diamond, hook, ball, and double ball tip picks; light, medium, and heavy weight tension wrenches; and saw type key extractors.

Tyro Pick Set

The Tyro Pick Set contains 6 picks, 2 tension tools and 1 broken key extractor. The tools are made of hardened spring steel and come with a top grain leather case with snap.



HP-PIP-15

Novice Pick Set

The Novice Pick Set contains 7 picks, 3 tension tools, and 1 broken key extractor. The tools are made of hardened spring steel and come with a top grain leather case with snap.



HP-PIP-13



HP-JKP-5

Jackknife Pick Set

The Jackknife Pick Set is a complete compact pick set, that is shaped like a pocket knife. It has 2 rakes, 1 diamond, 1 hook and 1 tension tool. The Jackknife folds up and fits in your pocket.

HP-JPO-1

LEATHER CASE FOR JKP-5

Double Sided Pick Set

The Double-Sided Pick Set contains 4 picks that can be used on the most popular double-sided, disc tumbler, showcase, cam, and padlocks.



HP-PKS

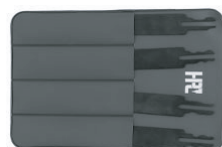

DSP-A
DSP-B
DSP-C
DSP-D

Double Sided Pick Set

The Double-Sided Pick Set contains 4 picks that can be used on the most popular double-sided, disc tumbler, showcase, cam, and padlocks.

HP-DSP-1

DISC TUMBLER PICK SET

Spring Steel Stainless Steel Handled Picks

HP-LPX-10 DIAMOND LOCK PICK

HP-LPX-11 RAKE LOCK PICK

HP-LPX-12 HOOK LOCK PICK

HP-LPX-15 RAKE LOCK PICK

HP-LPX-16 RAKE LOCK PICK

Spring Steel Picks

HP-BPX-51 HPC BALL PICK

Standard Tension Tools

HP-STW-3 VARIABLE-TENSION WRENCH

HP-TR-7 LIGHT-TENSION WRENCH

HP-TR-11 LIGHT-TENSION WRENCH

HP-TR-12 LIGHT-TENSION WRENCH

HP-TR-14 MEDIUM-TENSION WRENCH

HP-TR-25 MEDIUM-TENSION WRENCH

HP-TR-3 RIGID-TENSION WRENCH

HP-TR-4 RIGID-TENSION WRENCH

HP-TR-5 RIGID-TENSION WRENCH

HP-VV-6 TENSION WRENCH

EXTRACTOR SETS



HP-ES-2000

HPC EXTRACTOR SET

The 2000 Series Extractor Set is the ultimate in broken key and pick removal. The tools are designed to slide next to broken keys along the side mill and ride along the bottom pins to hook into a cut in the key. The tools are made of high grade stainless steel and can be bent to reach around many obstacles. This 4-piece set makes all other extractors obsolete.



HP-EZ-6

HPC INTERCHANGEABLE EXTRACTOR SET

The Interchangeable Extractor Set is the most popular extractor set on the market. Its compact size allows you to carry a variety of extractors inside this tiny set. It includes 4 extractor blades stored inside a hollow handle: 1 saw type extractor blade; 2 round extractors (.040" / 1mm diameter) and 1 round extractor (.050" / 1.27mm diameter).

INDIVIDUAL EXTRACTORS

HP-EZ-1	HPC EXTRACTOR (SAW TYPE)
HP-EZ-2	HPC HOOK EXTRACTOR
HP-EZ-5	HPC KEY EXTRACTOR (SPIRAL TYPE)
HP-EZ-7A	HPC REPL. SAW TYPE EXTRACTORS (10/PKGE)
HP-EZ-7B	HPC REPL. ROUND TYPE EXTRACTORS .040 (10/PKGE)
HP-EZ-7C	HPC REPL. ROUND TYPE EXTRACTORS .050 (10/PKGE)
HP-EZ-7D	HPC ASS'T EXTR.-EZ-6 (PKGE. OF 10 ASS'T)
HP-SSX-11	HPC EXTRACTOR
HP-SSX-20	HPC EXTRACTOR

TOOLS

SPECIALTY LOCKSMITH STAMPS

Permanently mark master or restricted keys with HPC's Specialty Locksmith Stamps. Let other locksmiths and key duplicators know it is a special purpose key and is part of a restricted system. The stamps are made of heavy duty steel stock, 3/8" (9.5mm) x 5/8" (16mm) with 1/16" (1.57mm) characters, hardened and zinc plated for years of trouble free service.



HP-LDNC	HPC 'DO NOT COPY' HAND STAMP
HP-LDND	HPC 'DO NOT DUPLICATE' HAND STAMP
HP-LMS	HPC 'MASTER' STAMP



HP-PTT-4

HPC PIN TWEEZER

Great for keeping your lock pins under control. Special groove at tip of tweezer holds pins securely.



HP-TRU-55

HPC TRUARC PLIERS

Combination Ring Spreading & Compressing Tool. Two pivot center allows for dual operation. No. 1 center is for compressing and No. 2 center is for spreading action. Changeovers are made quickly and easily.



HP-SUT-14

HPC PLUG FOLLOWER SET

Hollow Brass Follower Set contains 3 popular sizes of chrome plated, hollow brass followers. Use these followers on a variety of locks including the Corbin Russwin heavy duty knob lock cylinder units. The small diameter follower is useful for cabinet locks, peanut size cylinders, and pin tumbler letterbox locks.

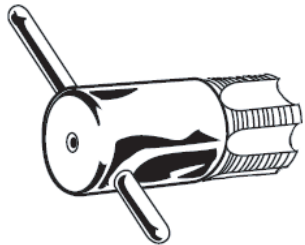

HP-CLT-4

MORTISE CYLINDER RE-TAPPING TAP

When mortise cylinders and lock cases are new they screw together without a problem. Often times a mortise cylinder is forced out of a lock without loosening the retaining screw. Other times an inexperienced person will force a mortise cylinder into a lock crooked. These actions result in stripping the threads of the cylinder or the lock case itself.

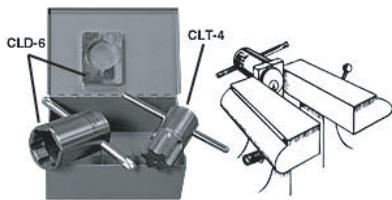

HP-CLTD-5

MORTISE CYLINDER TAP & DIE SET

The HPC Mortise Cylinder Lock Tap & Die Set was designed to repair this type of damage. The Tap can easily be twisted into a stripped lock case cutting new useable threads into an otherwise ruined lock. The Holding Fixture secures a stripped mortise cylinder in your vise while you use the Die to repair the threads.



HP-CPH-9

MULTIPLE PLUG HOLDER

The CPH-9 is a real space and time saver. This versatile holder is hardened and has a black-oxide finish. It conveniently mounts on your work bench allowing you to choose from any one of these 5 popular sizes:



HP-CPH-10

SOLID PLUG HOLDER

The CPH-10 is made of hardened bar stock and holds many popular plugs; including: Arrow, Corbin, Kwikset, Lockwood, Sargent, Schlage, Weiser and Yale.



HP-KFS-6

HPC KEY FILE SET

Includes six 4" (10cm) files with wooden handles in plastic case.

Files Included:

- | | |
|--------------------------------|------------------------------------|
| Swiss Pattern Round-Tapered | Swiss Pattern-Rectangular Straight |
| Swiss Pattern-3 Square Tapered | Swiss Pattern-Warding Tapered |
| Swiss Pattern Square-Tapered | Swiss Pattern-Half Round Tapered |

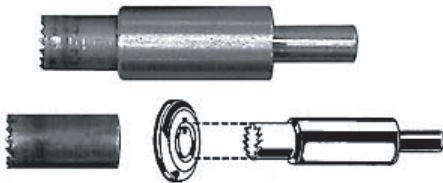

HP-AG-1

HPC TUBULAR LOCK SAW

If picking is not possible, lock-outs of tubular key locks can still be serviced. These hole saws destroy the pins at the shear line. Hole saws are available for standard and oversize keyways. Saws will fit any 1/4" (6.35mm) electric drill. Saw life is approximately 3 openings. Not for use on locks with hardened pins or ball bearings in the keyway

HP-G-1 HPC REPLACEMENT SAW FOR AG-1



HP-FIT-2

HPC FLIP IT

When picking a lock in the wrong direction (intentionally or by error) the Flip-It™ will flip the cylinder plug past the upper pins and save you the job of re-picking. It also works equally well on disc tumbler locks.

HP-FIT-2 HPC FLIP IT TOOL



HPC LARGE KEY RINGS

HPC's Large Key Rings are made of half-hard steel. The threaded fastener screws either to the left or the right allowing access on both sides or the ring. The 11" (27.94cm) ring slips over head easily for carrying around the neck and will hold about 260 keys.

- HP-LKR-11 11" DIAMETER**
- HP-LKR-6 6" DIAMETER**
- HP-LKR-8 8" DIAMETER**



GAK-6

GAK-4

HPC GIVE AWAY KEY RINGS

Give-Away Key Rings are manufactured from hardened .0475" (1.21mm) diameter spring steel wire. They are bright zinc plated to resist tarnishing. These rings are so inexpensive that they can be given away with every key you cut. Packed 1000 per box.

- HP-GAK-4 GIVE A WAY KEYRING 3/4" (1000 RINGS/BOX)**
- HP-GAK-6 GIVE A WAY KEYRING 1" (1000 RINGS/BOX)**



HPC GRAPHITE GUN

Use HPC's Graphite Gun prior to picking or impressioning to loosen tight wafers or pins. Graphite is also an excellent lubricant for machines.

HP-HGG RUBBER GRAPHITE GUN

KEY CABINETS - Single Key Kekabs®

Single-Tag KeKabs® - HPC's single-tag key security control system is designed to control and provide security for 8 to 730 keys. KeKabs® are ideal for home, store, or office use, where centralized or departmental key control is desired. They are designed to be mounted on a wall, near a desk or a work station.

Each HPC KeKab® Security Control System Includes:

White Plastic Key Tags with bright nickel plated snap-hooks which can hold multiple keys on each snap-hook. The tags are numbered for easy identification.

Durable Steel Key Racks that are slotted to store key tags uniformly for immediate identification.

"Out Key" Control Tags that are made of yellow paper. They are used for accountability (to record information on loaned keys).

Lock Location Data which consists of an erasable lock location chart as part of the KEKAB-8 and numbered key control booklets with all other KeKabs®.

It comes with a key retaining 5-wafer cam lock, a high security 7-pin tubular lock with pop out T-Handle, or electronic digital lock.

Unique powder coat textured painting process which provides an attractive and very durable finish. The neutral sand color allows them to be hung anywhere.

Heavy Gauge Steel Construction with piano hinged doors and key panels provides a sturdy location to secure your keys.

HP-KEKAB-A EXPANSION LEAF TO 330 KEYS (FOR KEKAB-160X)

HP-KEKAB-B EXPANSION LEAF TO 500 KEYS (FOR KEKAB-260X)

HP-PLT-1 PLAIN KEKAB TAGS (100/BOX)

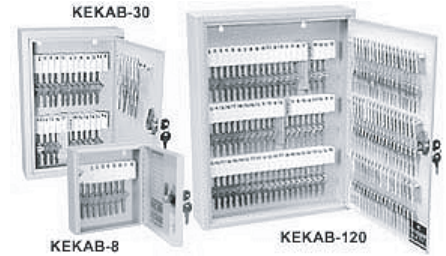

HP-KEKAB-8	8 KEYS
HP-KEKAB-30	30 KEYS
HP-KEKAB-40	40 KEYS
HP-KEKAB-60	60 KEYS
HP-KEKAB-80	80 KEYS
HP-KEKAB-120	120 KEYS
HP-KEKAB-160X	160 KEYS
HP-KEKAB-240	240 KEYS
HP-KEKAB-260X	260 KEYS
HP-KEKAB-330	330 KEYS
HP-KEKAB-500	500 KEYS

THE AUTO KEY KEEPER

The Auto Key Keeper™ will end the loss of auto keys on car lots!

Simply place a car's keys into the box. Lower the door window and slip the Key Keeper's back clip over the top edge of the glass.

Closing the window secures the box and keys locked within against

all but extreme and deliberate vandalism. A high security 7-pin tubular lock with dust cover offers excellent pick resistance and protection against the elements. An economical 5 wafer cam lock,

with dust cover, is also available. These boxes are made of 18 gauge steel with a charcoal grey baked enamel finish and a welded hinge to prevent knockout.

These boxes are made of 18 gauge steel with a charcoal grey baked enamel finish and a welded hinge to prevent knockout.

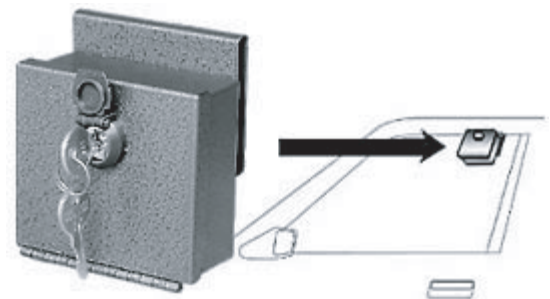

HP-KEP-14-95 AUTO KEY KEEPER KA-3395 (WITH TUBULAR LOCK)

SECURITY STORAGE

These boxes are designed to secure a restricted key where it is needed. The bright red steel box has a key-locking hinged door with a plexiglass window. When an emergency arises and access to the key is necessary, break the plexiglass with the attached hammer. The Fire Department Box comes with dark plexiglass to hide the contents. The Emergency Key Boxes come with a 5-wafer cam lock. Emergency Key Boxes are stocked keyed-randomly, and they can be keyed-alike or keyed-differently to meet virtually any security requirement.



STOCK NO.

511 (Emergency Key Box)

DIMENSIONS

6.625"H x 5.75"W x 2"D

WEIGHT

2 lb 6 oz

HP-511

EMERGENCY KEYBOX

HP-511GLASS

REPLACEMENT GLASS ONLY FOR 511

NOTES :

PATIO HARDWARE

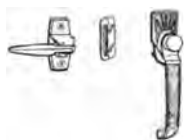

ID-SK11
PUSHBUTTON
LATCH

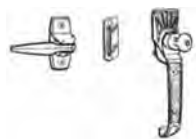

ID-SK12
PUSHBUTTON
LOCK



ID-SK910
CLASSIC
PUSHBUTTON
LATCH

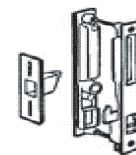

ID-SK804
FLUSH MOUNT
HANDLE SET
(KEY LOCK AVAIL.SK807)



ID-SK807
LOCKING
CYLINDER FOR
SK804



ID-SK9
PNEUMATIC
DOOR CLOSER



ID-SK80
PNEUMATIC
DOOR CLOSER
WITH CHAIN



ID-SK13
SUPER DOOR
SAVER



ID-SK805
HIGH PROFILE
HANDLE FOR
SK804

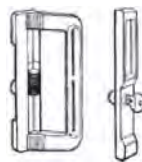

ID-SK800KBL
PATIO DOOR
HANDLE SET

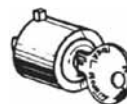

ID-SK8
PUSHBUTTON
KEYLOCK



ID-SK1994-W
"JD" PULL
HANDLE SET
(WHITE)



ID-SK10
ZD INSIDE
REPLACEMENT
LEVER



ID-SKT9303
KEYED "T"
GARAGE DOOR
LOCK



ID-SKL9201
KEYED
"L" HANDLE

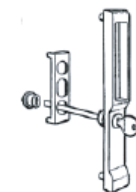

ID-SK801
OUTSIDE LOCKING
UNIT FOR USE
WITH SK800K



ID-SK5
STORM DOOR
DEADBOLT



ID-SK2
SOLID STRIKE

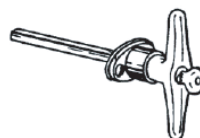

ID-SKT9303
ID-SKT9303KA
CHROME T-HANDLE

CODE KEY MACHINES

950C Computerized Code Machine *Do More. Have More. Affordably.*

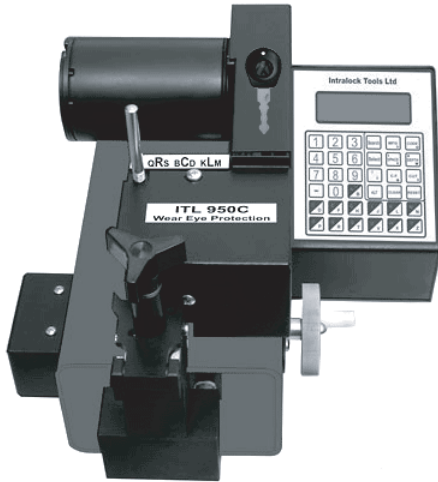

- 600+ spaces & depths
- 99 custom tables for new spaces & depths
- Normal (cut by cut) mode
- Laser cut mode
- Half-cut mode for progression
- Communication port
- Equipped with HSS M42 offset cutter
- One cutter does it all (except Medeco/ Emhart™)
- Medeco/ Emhart™ head and program included
- Inserts for double-sided automotive keys

IN-ITL950-C-MEDECO ITL PORTABLE KEY CODE MACHINE (STANDARD CUTTER)

9700A The Industrial Machine - Fast, Powerful and Reliable

Handles high volumes of keys in succession

- Medeco™ auto rotating head
- Recirculating bearings
- Typical cut rates:
- Standard - 15 seconds
- High Speed - 9 seconds
- Laser - 8 seconds
- Bi-Axial 6 pin - 16 seconds
- 600+ spaces & depths
- 99 custom tables for new depths and spaces
- Communication port
- One cutter does it all (with minor exceptions)
- Long-lasting carbide cutter included.
- Compatible with majority of commercially available software

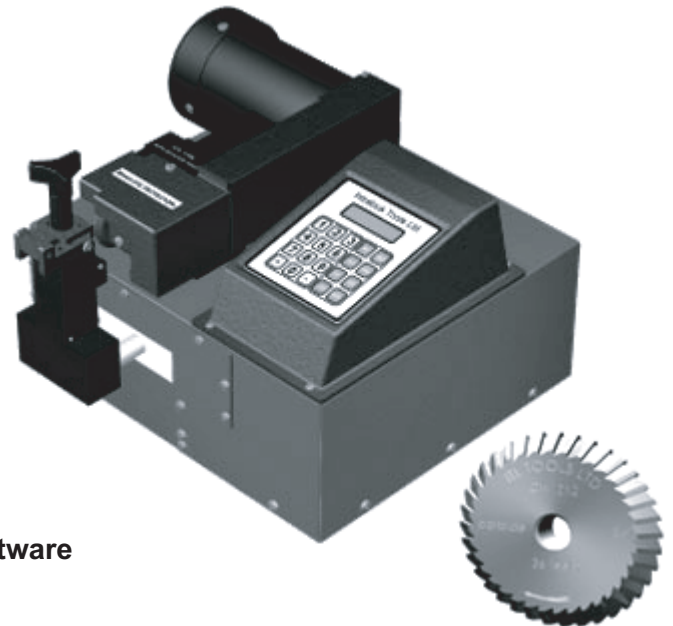

IN-ITL9700-AUTO-SWING ITL KEY CODE MACHINE WITH CARBIDE CUTTER

ELBOW CATCH



for use on the inactive leaf of a pair of cabinet doors; surface applied; cast aluminum.

IV-2A92

KICK DOWN



Cast Iron Construction
4" Arm Length. Sprayed Aluminum

IV-FS544-4"-SP28
IV-FS452-4"-US28

FLUSH BOLT FOR METAL DOORS



Ives manual flushbolt is used to securely lock the inactive leaf of the pair of doors. Standard bolt size is 12" and is not handed. ULC Listed.

IV-FB458-626

AUTOMATIC FLUSH BOLTS FOR METAL DOORS



Both bolts are nonhanded, but are not identical. The top bolt has no spring tension, resulting in lower actuation force with a smoother operation.

UL Listed 3 hours on 8'0" x 10'0" Opening

IV-FB31P-US32D

LOCKING SURFACE BOLTS



Ideal for all types of doors where a locking surface bolt is desired. UL listed and comes furnished with two keys. This locking surface bolt has a one inch throw, top and bottom strikes and is fully concealed to help prevent vandalism.

IV-SB1630-BL-KA-1360-US2G BOTTOM
IV-SB1630-TL-KA-1360-US2G TOP

MPOWER CLOSER



For use on solid-core and metal doors (85 lbs. maximum) up to 3'-0" (width) and 7'-0" (height). Full size template for easy installation. Powder-coat finish

IV-805SE-BOXED

GRAVITY DOOR COORDINATORS



When active door is open, coordinator prevents active door from closing until inactive door bypasses. Closing of inactive door causes strike plate on top of door to contact cam and lift arm, allowing active door to close. As inactive door continues closing, roller rides over strike plate on to door bracket, holding arm above active door.

- UL Listed for Fire Doors
- Non-handed

IV-COR-7G-US26D

3/4" OFFSET PIVOT SETS

Handed 3/4" offset pivot set consisting of a base plate mounted bottom pivot (handed) and a head frame mounted top pivot (non-handed). Has a maximum load of 200 pounds.

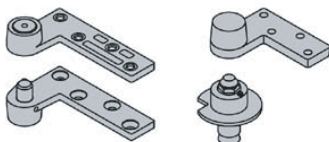

IV-7222-LH-628 TOP/BOTTOM, LEFT HAND
IV-7222-RH-628 TOP/BOTTOM, RIGHT HAND

CENTER HUNG PIVOT SETS

Center hung pivot set consists of a base plate mounted bottom pivot and a head frame mounted top pivot. Has a maximum load of 300 pounds.

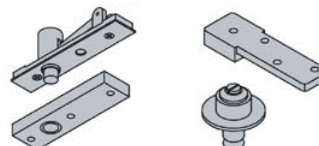

IV-7253-SP28

E-PLEX 2000



The E-Plex 2000 provides you with an economical way to step up to the benefits of electronic access control without breaking the bank.

- 100 access codes, including user and service levels
- Cylindrical latch
- Simple to install and maintain
- Easy to manage, no software required
- Key override available



Service Levels

- Master level** – performs all set-up and programming functions
- Manager level** – administers common programming functions
- Access user level** – entry granted with valid PIN
- Service level** – codes for single event or single day access, programmable in advance

Easy to Install

The E-Plex 2000 easily installs on wood or metal doors with ASA 161 door prep. Three through bolts secure the lock to the door.

UE-E2031-LL-626-41
 UE-E2031-XS-LL-626-41
 MG-1005-14S

NO KEY OVERRIDE
 KEY OVERRIDE C (1145) KEYWAY
 MAG PLATE FOR EPLEX 2000 (5 X 14)(2-3/4 BACKSET)

E-PLEX 5000



The Simplex and E-Plex 5000 Series is the complete toolkit for all your access control needs. Built on five decades of reliable and convenient keyless entry, this Series provides everything from the simplicity of mechanical single code access to the added security and features of electronic access control. Meet All Your Needs With The Simplex and E-Plex 5000 Series:

- Cylindrical, mortise or exit trim locking options
- PIN, PROX or dual credential access
- Single or multiple access codes
- Easy-to-use software available to simplify management of doors and access users
- Available features include audit trails, access schedules, remote unlock passage and privacy
- Quick and easy through-bolt installation
- No wiring to or through the door



E5731

- UE-E5031-XS-WL-626-41 ELECTRONIC PUSHBUTTON, SCHLAGE C KEYWAY
- UE-E5031-B-WL-26D-41 ELECTRONIC PUSHBUTTON, ACCEPTS BEST I/C CORE
- UE-E5031-M-WL-626-41 ELECTRONIC PUSHBUTTON, ACCEPTS MEDECO I/C CORE
- UE-E5066-M-WL-626-41 FOR MORTISE LOCKS ACCEPTS MEDECO I/C CORE
- UE-E5066-S-WL-626-41 FOR MORTISE LOCKS ACCEPTS SCHLAGE I/C CORE
- UE-E5231XS-WL-626-41 ELECTRONIC PUSHBUTTON, SCHLAGE C KEYWAY
- UE-E5710-XS-WL-626-41 FOR EXIT DEVICE, PROX, C KEYWAY
- UE-E5710-B-WL-626-41 FOR EXIT DEVICE, PROX, ACCEPTS BEST I/C CORE
- UE-E5731-XS-WL-626-41 FOR EXIT DEVICE, C KEYWAY, PROX, 3000 CODES
- UE-E5731-B-WL-626-41 FOR EXIT DEVICE, BEST I/C CORE, PROX, 3000 CODES

E-PLEX 3000 NARROW STILE LOCK

The E-Plex 3000 has 300 access codes and a 9,000-event audit trail, that also records key override usage. It can be programmed at the lock keypad or with optional Microsoft Excel based software. Installation is quick and easy with no wiring to or through the door - eliminating the risk of damaged or pinched wires. The battery pack, consisting of four (4) AA batteries, is located in the tamper proof base of the housing and provides 180,000 cycles. The lock is available in Standard Satin Chrome or optional Dark Bronze with Satin Brass accents. The lock comes with a 3-year warranty. It is part of the E-Plex brand of electronic access control locks that offer "A Solution for Every Door ... And Every Budget."



Features

Construction: All metal; cast front housing
Latch hold-back standard
Door handing: Non-Handed
Numeric pushbuttons: Vandal resistant, 10 button, anodized aluminum
Weight: 5.1 lbs.
Stile width: 2" minimum, required for mounting
Door thickness: 1-3/4" maximum
Strike: Provided by Adams Rite
Latch: Provided by Adams Rite
Backset: 31/32" (25 mm) or 1 1/8" (29 mm)
Finishes: Satin Chrome 26D (626); (744) Bronze
Environmental operating conditions: Highly weather resistant
Code: Up to 300 Access Codes, Thousands of combinations
Emergency access: Mechanical Key override

The E-Plex 3000 is designed to retrofit inside trim for Adams Rite locks 1850 1950, 4070, 4510, 4520, 4530, 4710, 4720, 4730, 4900, 4920AN, MS 1850S and MS 1950S Series (Not Included).

UE-E3065-MS-NL-626-41 NARROW STILE EPLEX MORTISE, DEADLATCH, LEVER
UE-E3066-MS-NT-626-41 NARROW STILE EPLEX FOR MS1850S, THUMBTURN

E-PLEX PARTS AND ACCESSORIES

UE-EP-0300-SW	E-PLEX 3000/5000 STANDARD SOFTWARE (300 USERS)
UE-EP3000-SW	E-PLEX ACS SOFTWARE FOR E5200-E5700 EPLEX
UE-065-101066	PROXCARD 2 HID1326 FOR POWER LEVER
UE-065-507143	HID PROX CARDS FOR E5700 SERIES UNICAN
UE-120-508051	HID PROX KEY II #1345 (FOB) FOR E5700 SERIES
UE-54561-000-41	USB PROX ENROLLER FOR E5700 EPLEX/POWER LEVER
MG-502-S	MAG PLATE FOR E-PLEX 5700 (5 X 14) (2-3/4 BACKSET)
MG-1005-14S	MAG PLATE FOR E-PLEX 2000 (5 X 14) (2-3/4 BACKSET)

850L SOLITAIRE LEARN LOK

Ideal for facilities up to 25 users and under 10 doors.

This is the fastest to install, and our most economical system. It requires no computer. The lock "learns" to recognize each user's card when you swipe the "Learn" card through the lock, followed by the user's card. A few minutes of set-up, and you have a fully functioning access control system. You can add or remove users at anytime.

You can supply users with a keycard, or they can use their personal card (credit card, phone card, store card, gas card, etc.). In order to protect from credit card fraud, the system never records the complete credit card number.

LEARNLOK
FUNCTION CARDS



UE-SP850L-2EM	UNICAN STARTER PACK
UE-UP850L-2EM	UNICAN USER PACK (INCLUDES 25 USER/25 CANCEL CARDS)

850 PARTS

UE-SP850L-2EM	UNICAN STARTER PACK
UE-UP850L-2EM	UNICAN USER PACK (INCLUDES 25 USER/25 CANCEL CARDS)
UE-LOC-F0900-B018	UNICAN SYSTEM 900 LO-COERCIVITY KEYCARDS
UE-HIC-F0850-BLAN	UNICAN HI-C KEYCARD FOR SOLITAIRE 850
UE-502238-10	KABA-ILCO BATTERY PACK FOR 800/900 (10 PACK/BOX)

1000 SERIES

FEATURES

One-hand operation: Depress the buttons in the correct sequence to unlock the deadlocking latch.

Thousands of possible combinations:

Authorized individuals can change the combination in seconds.

Easy to install on wood or metal doors:

The lock retrofits cylindrical and tubular lockset with 2-3/4* (70 mm) backset. An inside trim plate adds to the ease of installation and aesthetic appeal.

Rugged & weather resistant



APPLICATIONS

The 1000 Series lock provides fully mechanical pushbutton access control with no electrical wiring, electronics, or batteries. Exterior access is by combination. Egress is by interior knob and is free at all times.

1000 Series locksets are the best choice for limiting access to high-traffic, security-sensitive areas in commercial, institutional, residential, and industrial buildings. These locks are ideal for locations with a high personnel turn over rate such as data processing centers, employee entrances, R&D labs, apartments, dormitories, and restricted areas in hospitals and airports.

IL-1011-03

POLISHED BRASS

STANDARD ACCESS

IL-1011-05

ANTIQUÉ BRASS

STANDARD ACCESS

IL-1011-26D

SATIN CHROME

STANDARD ACCESS

IL-1021A-26D

SATIN CHROME

KEY OVERRIDE

IL-1021B-26D

SATIN CHROME

KEY OVERRIDE

IL-1021C-26D

SATIN CHROME

KEY OVERRIDE

IL-1021M-26D

SATIN CHROME

KEY OVERRIDE

IL-1021R-26D

SATIN CHROME

KEY OVERRIDE

IL-1021S-26D

SATIN CHROME

KEY OVERRIDE

IL-1031-26D

SATIN CHROME

PASSAGE FUNCTION

IL-1041B-26D

SATIN CHROME

KEY/PASSAGE FUNCTION

IL-1041C-26D

SATIN CHROME

KEY/PASSAGE FUNCTION

IL-1041M-26D

SATIN CHROME

KEY/PASSAGE FUNCTION

IL-1041R-26D

SATIN CHROME

KEY/PASSAGE FUNCTION

IL-1041S-26D

SATIN CHROME

KEY/PASSAGE FUNCTION

ASSA I/C

BEST/FALCON I/C

CORBIN I/C

MEDECO/YALE I/C

SARGENT I/C

SCHLAGE I/C

BEST/FALCON I/C

CORBIN I/C

MEDECO/YALE I/C

SARGENT I/C

SCHLAGE I/C



L1000 SERIES

FEATURES

One-hand operation: Depress the buttons in the correct sequence to unlock the deadlocking latch. Thousands of possible combinations:

Authorized individuals can change the combination in seconds.

Easy to install on wood or metal doors. The lock retrofits cylindrical and tubular lockset with 2-3/4* (70 mm) backset. An inside trim plate adds to the ease of installation and aesthetic appeal. Rugged & weather resistant

IL-L(L/R)1011-26D

STANDARD ACCESS

IL-L(L/R)1021B-26D

KEY OVERRIDE

BEST/FALCON

IL-L(L/R)1021C-26D

KEY OVERRIDE

CORBIN

IL-L(L/R)1021M-26D

KEY OVERRIDE

MEDECO/YALE

IL-L(L/R)1021R-26D

KEY OVERRIDE

SARGENT

IL-L(L/R)1021S-26D

KEY OVERRIDE

SCHLAGE

IL-L(L/R)1031-26D-41

KEY/THUMBPIECE

PASSAGE



LP1000 SERIES



FEATURES

One-hand operation: Depress the buttons in the correct sequence and rotate lever to retract latch.

Thousands of possible combinations: Authorized individuals can change the combination in seconds.

Rugged & weather resistant: The lock is wear tested for intensive use.

Exit device compatibility:

- Von Duprin Exit Only (EO) or Exit Only Fire (EOF) 22, 88 (EO), 98, 99, 900, 9859, 9957, 90027, 90047WDC, 90057
 - Detex Advantex Series 10, 20, 21, 40, 50, 51;
 - Monarch XX-R*, FXX-R, 18-R*, F-18-R*, 17-R, F-17-R, XX-V*, F-XX-V*, 18-V*, F-18-V*, 11-R*, 11-V*
- *Requires special k-hub adapter.

IL-L(L/R)P1010-26D
IL-L(L/R)P1020B-26D
IL-L(L/R)P1020M-26D
IL-L(L/R)P1020R-26D
IL-L(L/R)P1020S-26D

SATIN CHROME	STANDARD ACCESS
SATIN CHROME	KEY OVERRIDE
SATIN CHROME	KEY OVERRIDE
SATIN CHROME	KEY OVERRIDE
SATIN CHROME	KEY OVERRIDE

BEST/FALCON
MEDECO/YALE
SARGENT
SCHLAGE



2015 SERIES

FEATURES

Mechanical control of electrical switch:

The lock does not draw current.

Versatile: Compatible with existing wiring systems; operates all makes and voltages of electric releases.

Can be wired for fail-safe or fail-secure.

One-hand operation: Depress the buttons in the correct sequence and rotate the thumbturn to activate the switch.



The **2015 Series** lock is a fully mechanical pushbutton access control with no electrical wiring, electronics, or batteries. This lock is designed to operate surface mounted exit devices (not supplied) from the outside using a tailpiece, replacing the key cylinder on new or existing devices. Any standard pull can be mounted with the 2015 Series. Exterior access is by combination. Egress is by interior exit device and is free at all times.

IL-2015-26D-41-KA-SL31
FOR PANIC DEVICES

IL-74166-KA-SL31
CONTROL LOCK FOR THE 2000 SERIES

2015 Exit device compatibility:

- Adams Rite 3700 Rim, 8800 Rim, 8700 Rim
- American Device 6300 Series, 6303 Series
- Corbin 21, 22, 25, 26NT, 27K, 29, 29-1/4, 29M2,291/2M2,29NTM2, 29D20, LA29, 39, 39EL, 39LLD, 39O, LA39
- Detex Advantex Series 10, 20,21, 40, 50,51
- Magno Krom LHR only: 500-4, 550-4, 650-4, 1500-4, 1550-4, 1650-4; RHR only: 600-3
- Monarch 18RBA, 18RP, 18VP, F18RBA, F18RP, F18VP, FXXRBA, FXXRP, FXXVP, XXRBA, XXRP, XXVP
- Precision Hardware FL-D103; RHRB only 810-H; RH or LH: 103, R103, D203, H-203, 1103, D1203, H1203
- Russwin 365, 3651/4, LT365, 370, 372, LA372, 375, LT375, 377, 382, 384, 385, 388, 572, 572EL, 572ELD, U572, LA572
- Sargent 2813, 2804, 6804, 12-6804, 9804RHRB, 12-9804LHRB, 9898E, 9898K
- Von Duprin 22 Rim, 22 Rim-F, 88 Rim, 88 Rim-F, 98 Rim, 98 Rim-F, 99 Rim, 99 Rim-F; 2227, 2227-F, 9827, 9827-F, 9847, 9847-F, 9927-F, 9947-F;
- Yale 1500 Series, 7000 Series

3000 SERIES



The heavy-duty fully mechanical 3000 Series keyless lock offers slim-line access control for narrow stile aluminum and glass entrance doors. This push button lock has a control key that deactivates and activates the combination. Used as a day/night control, this key can prevent unauthorized re-entry after hours via the combination. The control key can also activate a latch holdback feature to allow free access during business hours. Designed for use with Adams Rite #4710 latch mechanisms and with most Adams Rite egress hardware. Any standard mortise cylinder that operates the Adams Rite latch will function with a 3000 Series lock. Adams Rite key cylinders/latches/ egress hardware not provided with lock. Visual shield inhibits unauthorized observation of the entry code.

STANDARD LOCK HOUSINGS

IL-3001-55	DURONODIC
IL-3001-26D	SATIN CHROME

HOUSING WITH CYLINDER GUARD

IL-3002-55	DURONODIC
IL-3002-26D	SATIN CHROME

DRIVE ASSEMBLY

IL-3010-19	31/32" BACKSET, RIGHT HAND
IL-3020-19	31/32" BACKSET, LEFT HAND
IL-3030-19	1-1/8" BACKSET, RIGHT HAND
IL-3040-19	1-1/8" BACKSET, LEFT HAND

5000 SERIES

The Simplex 5000 lock provides fully mechanical pushbutton access control without any wiring, electronics, or batteries. Exterior access is by combination. Egress is by interior lever and is free at all times. Lock is ADA compliant.

Ideal for controlling access to high-traffic, security-sensitive areas in commercial, industrial, educational, governmental, lodging, and multi-unit residential settings. Perfect for locations with a high user turnover rate such as data processing centers, employee entrances, apartments, dormitories, and restricted areas in hospitals and airports.

- IL-5010XS-WL-26D-41 FOR EXIT DEVICE , KEY OVERRIDE
- IL-5021XS-WL-26D-41 CYLINDRICAL PUSHBUTTON, KEY OVERRIDE
- IL-5041XS-WL-26D-41 CYLINDRICAL PUSHBUTTON, KEY OVERRIDE WITH PASSAGE FUNCTION



- Handing is reversible
- Comes standard with a regular key cylinder for key backup at no extra charge.
- Special high security restricted keyway.
- Very heavy duty grade one
- No batteries needed - completely mechanical

7000 SERIES

The 7000 Series pushbutton lock provides convenient auxiliary indoor/outdoor protection for commercial and residential applications. This lockset can be mounted above existing primary locksets or used alone.

- IL-7102-03-41 DEADBOLT, BRASS - PVD
- IL-7102-26D-41 DEADBOLT, SATIN CHROME
- IL-7104-03-41 DEADLATCH LOCK, BRASS -PVD
- IL-7104-26D-41 DEADLATCH LOCK, SATIN CHROME
- IL-7106-26D-41 RIM LOCK, SATIN CHROME
- IL-7108-03-41 DEADBOLT, 2-3/8 BACKSET, BRASS-PVD
- IL-7108-26D-41 DEADBOLT, 2-3/8 BACKSET, SATIN CHROME



- Rugged weather-resistant all-metal construction
- Fully mechanical - not affected by power failures
- Clutch-protected turn knob cannot be forced
- No keyway to be picked
- Large easy-to-depress pushbuttons
- One-hand operation

1000 SERIES UNICAN PARTS

IL-203035-000-45	KABA-ILCO 1000 SERIES SERVICE PARTS KIT
IL-201499-045-01	Sleeve Drive Assembly-Standard Includes 201378,201376,201498, (Old # 201062-045-01)
IL-201278-018-01	Installation Wrench Includes D59 key
IL-201284-26D-01	Knob Assembly- Standard
IL-201335-045-01	Combination Change Stud
IL-74366-000-01	Combination Chamber M-56/ M-63 (Old # 201429-000-01)
IL-201430-000-01	Clutch Sub-assembly (Includes: 201016, 201709, 201425)
IL-201437-000-10	Roll Pin (For Shaft Assembly 0.1" (2.5 mm) dia.)
IL-201825-000-01	Chamber Release (For models with passage set)
IL-201382-05-01	Knob Key Override Assembly- (For Best / Falcon / Arrow / Eagle / KSP/ Lloyd Matheson)
IL-201382-26D-01	Knob Key Override Assembly- (For Best / Falcon / Arrow / Eagle / KSP/ Lloyd Matheson)
IL-201440-000-05	Retainer Ring 3/8" (9 mm) I.d. (For passage set and combination change sleeve)
IL-201547-045-01	Shaft Assembly -Key Override (Old # 201267-045-01)
IL-201548-045-01	Sleeve Drive Assembly (For Medeco/Yale) (User spacer no.201569 for 5-pin Medeco core)
IL-201600-19-41	Anti-spy Shield (1000-22-19) Black only
IL-201144-26D-01	3/4" (19mm) latch carries 3-hour UL/ULC fire / A -labelled doors 2 3/4" (70mm) backset.
IL-201597-26D-01	DL Removable Core Cylinder
IL-201040-000-01	Knob Return Spring Includes stop plate
IL-201519-26D-01	Medeco/Yale Conversion Assembly Request Spacer 201569 for 5-pin Medeco. (M)
IL-201532-260-01	Sargent Conversion Assembly (R)
IL-201558-260-01	Schlage Conversion Assembly (S)
IL-201825-000-01	Chamber Release Includes: 201351, 201352, 201440, 201350, 201824
IL-204168-26D-01	1/2" Free Floating Latch

L1000 SERIES UNICAN PARTS

IL-203037-000-01	KABA-ILCO L1000 SERIES SERVICE KIT (RIGHT HAND)
IL-203038-000-01	KABA-ILCO L1000 SERIES SERVICE KIT (LEFT HAND)
IL-203039-000-01	KABA-ILCO LRP1000 SERVICE KIT (RIGHT HAND)
IL-201727-26D-01	Fixed Sleeve RH
IL-201730-000-01	Inside Lever Coil Return Spring RH
IL-201732-000-01	Inside Lever Coil Return Spring LH
IL-201733-26D-01	Fixed Sleeve LH
IL-201745-05-01	Unified Trim Plate -Passage Set
IL-201745-26D-01	Unified Trim Plate -Passage Set
IL-201818-26D-01	Plug Assembly (for passage set with 2 keys. (Includes: 201422)
IL-201824-045-01	Chamber Release Cam (For Passage Set)
IL-201825-000-01	Chamber Release (for Passage Set)
IL-204023-000-01	Latch Extension Assembly to Convert to 5" (13cm) backset.
IL-201788-000-01 RH	Clutch Assembly (201709 & 201768)
IL-201789-000-01 LH	Clutch Assembly (201709 & 201768)
IL-201785-26D-01	Inside Lever Assembly RH (Includes 201727, 201732, 201730, 201733, 201734,201784)
IL-201786-26D-01	Inside Lever Assembly LH (Includes 201727, 201732, 201730, 201733, 201734,201784)
IL-201787-26D-01	Combination Change Plug Assembly with 2 keys (Includes 200079, 201298 & IL-201442)
IL-74303-000-01	Tail Piece Assembly

2000/2015 SERIES UNICAN

IL-200013-26D-01	Replacement Thumbturn
IL-74166-KA-SL31	Control Lock
IL-742412-000-01	Combination Chamber For 2015 Series
IL-74459-000-01	Combination Chamber for 2000 Series (M57/M67)
IL-74303-000-01	Tail Piece Assembly

3000 SERIES UNICAN PARTS

IL-54114-000-10	Retaining Ring (For slide, stud code lever, and interposer)
IL-54237-000-10	Extension Spring (For slide stile plate assembly)
IL-64755-000-01	Clutch Assembly (3000) (OLD #74344-000-01)
IL-74354-000-01	Interposer Drive and Ball Assembly Includes 24178, 54114, 54242, 74340, & 74341
IL-74348-000-01	Code Change Assembly Includes 54243, 54244, 54245, 54246, 74346, 74347, & 74353 74348-000-01
IL-74366-000-01	Combination Chamber M-56/ M-63 (Old # 201429-000-01)

5000 SERIES UNICAN PARTS

IL-544820-000-01	Inside/Outside Spring
IL-64724-000-01	6/7 Pin Tailpiece
IL-74832-000-01	5000 Series Combination Chamber

6000 SERIES UNICAN PARTS

IL-74870-000-01	Combination Chamber (M64) (Old # 55013-000-01)
IL-55091-000-01	Force Proof Clutch Assembly
IL-55115-26D-01	Latch for model 6014 or 6118 Standard duty; 1/2" (13mm) throw; 2 3/8"(60mm) backset

7000 SERIES UNICAN PARTS

IL-202052-03-41	Replacement 2 3/4" Backset Bolt Only, Brass Finish (7102)
IL-202064-03-41	Replacement 2 3/8" Backset Bolt Only, Brass Finish (7102)
IL-202007-045-01	Tailpiece (For Latch/Deadbolt)
IL-202020-26D-01	Connecting Bolts Flat Head Phillips Screws
IL-202025-26D-01	Inside Turn Knob and Rose Assembly For Model 7002, 7004, 7008 & 7014.
IL-54444-03-01	7014 Latch Bolt Assembly Adjustable 2 3/4" (70mm) & 2 3/8" (60mm) backset
IL-74660-000-01	Combination Chamber

RW4 Professional Key

Designed for the security Professional, the RW4 will clone both Texas Instruments® (TI) encrypted and fixed code transponder keys at the counter. Use this key duplicator with Ilco Electronic Keys to eliminate the need for two master (original) keys that are required for “on-board programming”.

- Clones TI fixed and encrypted transponders
- Clones fixed (T2, T5) code transponders
- Identifies transponders
- Indicates chip type, value, and manufacturer
- Archiving capability
- Updatable software
- Built in “Soft Touch” keyboard
- Easy to read LCD screen
- Multiple language support

The RW4 is compact, portable, and with the 12VDC power adapter, it's perfect for “on the road services”.



IL-RW4 RW4 TRANSPONDER KEY DUPLICATOR/READER

TRANSPONDER Programmable Keyblanks

KB-B100-PT5	GENERAL MOTORS		KB-Y160-PT	DODGE/CHRYSLER
KB-B103-PT5	PONTIAC		KB-Y164-PT	DODGE/CHRYSLER
KB-B103-PT	PONTIAC		KB-MIT11R-EK	MITSUBISHI
KB-B111-PT	CHEVROLET		KB-H72EK	FORD
KB-B97-PT5	GENERAL MOTORS		KB-H84EK	FORD/MAZDA
KB-B98-PT5	GENERAL MOTORS		KB-MAZ24REK	MAZDA
KB-B99-PT5	GENERAL MOTORS		KB-MIT11R-EK	MITSUBISHI
KB-H73-PT	FORD		KB-NSN14EK	NISSAN
KB-H74-PT	FORD		KB-TOY43EK2	TOYOTA/LEXUS
KB-H86-PT	MAZDA		KB-TOY48EK2	TOYOTA/LEXUS
KB-HD106-PT5	HONDA		KB-Y160EK	DODGE/CHRYSLER

PLEASE ALWAYS REFER TO THE AUTO/TRUCK KEY BLANK REFERENCE GUIDE

250 BULK PACKS



DE6-BR	DEXTER	WR5-NP	WEISER
Y1-BR	YALE#9	SC1-NP	SCHLAGE C
KW1-NP	KWIKSET	SC1-BR	SCHLAGE C
WR3-BR	WEISER	SC4-NP	SCH. C 6-PIN
SE1-BR	SEGAL	SC4-BR	SCH. C 6-PIN
WR5-BR	WEISER	M1-BR	MASTER 1092
Y11-BR	YALE		

KEY CUTTING MACHINES



Bravo III

Semi-Automatic (Lever) Operation

A high quality, sturdy key duplicator designed to deliver years of service. The Bravo III has precision "no slip" performance vise jaws, twin shaft carriage transport design, spring loaded carriage, and a micrometer adjustable cutter guide. Delivers unsurpassed accuracy and cutting performance.

IL-BRAVO-III-USA-110VAC



044



045

044 Performance Series

Semi-Automatic (Lever) Operation

The 044 "Performance Series" duplicator is specially designed for cutting popular automotive and commercial cylinder keys, but with added speed compared to manually operated machine models. Lever operated, the 044 will duplicate most keys in 9 seconds or less. Machine controlled cutting pressure provides for more consistent results, especially when several people routinely operate the same machine. This model is ideal for counter or mobile use.

IL-044-110VAC

SEMI-AUTOMATIC

IL-045-110VAC

MANUAL

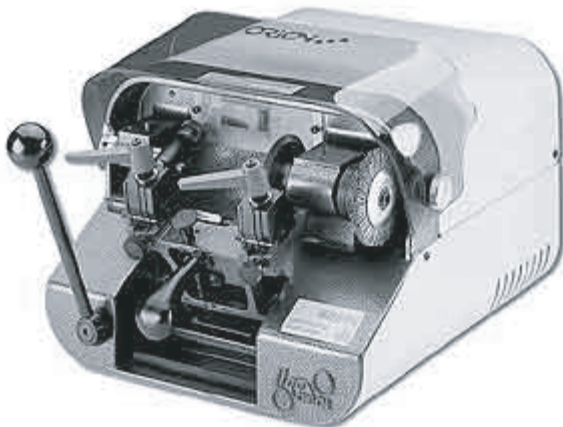

KD50C

Semi-Automatic (Lever) Operation

A superbly crafted machine, the lever operated KD50C provides remarkable speed and accuracy. Cuts single sided keys in as little as 5 seconds! The vise jaws are engineered to securely grip even the most troublesome double-sided auto keys. This model delivers unsurpassed accuracy and cutting performance. Loaded with features every user will appreciate.

IL-KD50C-110VAC

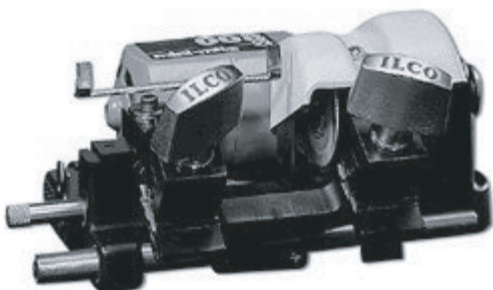

008A

Mini-Mite Manual Operation

The 008A "Mini-Mite" is a lightweight, compact yet versatile machine that is perfect for carrying right to the job. Perfect for mobile shops, or wherever space is tight.

IL-008A-12VDC

KEY MACHINE PARTS

IL-CU50A	CUTTER FOR KD50C/BRAVO II/BRAVO III
IL-D301681ZZ	BELT FOR BRAVO KEY MACHINE
IL-D301840ZZ	BRUSH FOR BRAVO KEY MACHINE (BRAVO I - II)
IL-D305444ZZ	MAIN SWITCH FOR BRAVO MACHINE
IL-D400875ZZ	CUTTER FOR BRAVO-USA-KEY MACHINE (NOT II -III)
IL-D401606ZZ	JAW SPRING FOR BRAVO MACHINE
IL-D405278LA	JAW STUD FOR BRAVO MACHINE
IL-D504875ZM	MICRO SWITCH ASSEMBLY FOR BRAVO MACHINE
IL-D507215BA	JAW SET FOR BRAVO USA/BRAVO II MACHINE
IL-D902170ZR	JAW HANDLE FOR BRAVO MACHINE
IL-D909416ZR	BRUSH SWITCH FOR BRAVO MACHINE
IL-D925102ZR	NYLON BRUSH STRICTLY FOR BRAVO III
IL-025-20	CUTTER SHAFT BUSHING FOR 044 MACHINE
IL-025-21	CARRIAGE SHAFT BUSHING FOR 044 MACHINE
IL-025-2	CARRIAGE STUD FOR 044 MACHINE
IL-025-3X-SUPER JAW 2	SUPER JAW 2 FOR 044/045 KEY MACHINE
IL-025-48	V-BELT FOR 044/045 KEY MACHINE
IL-025-49	CUTTER GUIDE [STYLUS] FOR 044/045 MACHINE
IL-025-4	WISE JAW SPRING FOR 044 MACHINE
IL-025-62A	ON/OFF SWITCH FOR 044/045/046 MACHINE
IL-025-6X	THRUST BEARING SET FOR 044 MACHINE
IL-CU20	CUTTER FOR 024A, 040 & 044
IL-KD50-111	SERVICE BAR KD50 KEY MACHINE
IL-KD50-18	LIGHT BULB FOR KD50
IL-KD50-39	CARRIAGE SPRING FOR KD50C
IL-KD50-46	CUTTER STARTING SWITCH FOR KD50A MACHINE
IL-KD50-52	JAW/WISE SPRING FOR KD50A MACHINE
IL-KD50-55	POST FOR KD50 KEYMACHINE
IL-KD50-58	CLAMP ASSEMBLY FOR KD50A MACHINE
IL-KD50-59	THRUST WASHER FOR KD50A MACHINE
IL-KD50-62	CARRIAGE HANDLE FOR KD50 KEY MACHINE
IL-KD50-89A	KEY/CUTTER GUIDE FOR KD50A MACHINE
IL-KD50-8A	BELT FOR KD50A MACHINE
IL-KD50-J	UPPER & LOWER WISE JAW FOR KD50A MACHINE
IL-KD50A-102B	NYLON BRUSH FOR KD50C KEY MACHINE
IL-KD50A-15	ON/OFF SWITCH FOR KD50A/KD94
IL-KD50A-21	MOMENTARY SWITCH FOR KD50A MACHINE
IL-KD50A-63-HANDLE	CARRIAGE HANDLE ASSY C/W THREAD FOR KD50

TOOLS

827-00-8X

IL-827-00-8X	PICK GUN
IL-827A-00-15	PICK GUN BLADE P28 (STRAIGHT) (OLD# 827-01)
IL-6R	6" ROUND FILE
IL-6W	6" WARDING FILE

SAFE LOCK BODIES, DIALS AND RINGS

US-670F21-98-41	ILCO CONVERTIBLE FOR LOCKING DIAL & RING
US-673000-60-41	ILCO SAFE LOCK BODY ONLY

CYLINDERS

Machined solid brass cylinders for longer life, highest quality, and the best Master Keying Largest Lock Cylinder replacement line in the industry

KABA/ILCO KEY-IN-KNOB CYLINDERS IN MAJOR MANUFACTURERS KEYWAYS DRILLED 6 PIN PINNED 5



IL-15395CC-26D-KD	R1001N/ 77 KEYWAY
IL-15395DA-26D-KD	S54F/ D06 KEYWAY
IL-15395FA-26D-KD	1022 KEYWAY
IL-15395GB-26D-KD	SARGENT LA-LC KEYWAY
IL-15395SC-26D-KD	1145A / C KEYWAY
IL-15395SX-26D-KD	A1145/ C-K KEYWAY
IL-15395WA-26D-KD	A1054WB WEISER KEYWAY
IL-15395XE-26D-KD	67-DEXTER KEYWAY

KEY-IN-KNOB / DEADBOLT CYLINDERS (BC160P) IN MAJOR MANUFACTURERS KEYWAYS



IL-15995AA-26D-KD	SEGAL
IL-15995CA-26D-KD	A1001EH/ 60 KEYWAY
IL-15995CC-26D-KD	R1001EN/ 77 KEYWAY
IL-15995CD-26D-KD	59A1-A2 KEYWAY
IL-15995CE-26D-KD	A1011L4 KEYWAY
IL-15995DA-26D-KD	S54F/ D06 KEYWAY
IL-15995FA-26D-KD	1022 KEYWAY
IL-15995GB-26D-KD	SARGENT LA-LC KEYWAY
IL-15995RA-26D-KD	1011P RUSWIN KEYWAY
IL-15995SC-26D-KD	1145A / C KEYWAY
IL-15995SX-26D-KD	A1145/ C-K KEYWAY
IL-15995WE-26D-KD	A1054WB WEISER KEYWAY
IL-15995XE-26D-KD	67-DEXTER KEYWAY
IL-15995YA-26D-KD	9 / 999 YALE KEYWAY
IL-15995YG-26D-KD	998GA YALE KEYWAY

MORTISE CYLINDERS IN MAJOR MANUFACTURERS KEYWAYS, 1-1/8" DRILLED 6 PIN PINNED 5



IL-7124DA2-26D-KD	S54F(4PIN)	3/4"
IL-7165DA2-26D-KA2	S54F / DO6	1"
IL-7165KS2-26D-KD	1176	1"
IL-7165SC2-03-KD	1145	1"
IL-7165SC2-13-KD	1145	1"
IL-7165SC2-26D-KA2	1145	1"
IL-7165SC2-28-KD	1145	1"
IL-7165SX2-26D-KD	1145L	1"
IL-7165WE2-26D-KA2	A1054WB	1"
IL-7165YA2-26D-KD	999	1"
IL-7185CD1-26D-KD	59A1, 59A2	1-1/8"
IL-7185CA1-26D-KD	A1001EH	1-1/8"
IL-7185CE1-26D-KD	A1011-L4	1-1/8"
IL-7185DA1-26D-KD	S54F/DO6	1-1/8"
IL-7185GB1-26D-KD	LA-LC	1-1/8"
IL-7185SC1-03-KD	1145A	1-1/8"
IL-7185SC1-26D-KA2	1145	1-1/8"
IL-7185SC1-26D-KD	1145	1-1/8"
IL-7185SX1-26D-KD*	A1145L	1-1/8"
IL-7185WA1-26D-KD	A1054WB	1-1/8"
IL-7185YA126D-KD	999	1-1/8"
IL-7185YG1-26D-KD	998GA	1-1/8"
IL-7205SX1-26D-KD	A1145L	1-1/4"

RIM CYLINDERS IN MAJOR MANUFACTURERS KEYWAYS SATIN CHROME FINISH, DRILLED 6 PIN PINNED 5



IL-7015CA8-26D-KD	A1001EH
IL-7015DA8-26D-KD	S54F-D06
IL-7015GB8-26D-KD	LA-LC
IL-7015KS8-26D-KD	1176
IL-7015SC8-26D-KD	1145
IL-7015SX8-26D-KD	A1145L
IL-7015WE8-26D-KD	1054WB
IL-7015YA8-26D-KD	999
IL-7015CD8-26D-KD	59A1, 59A2

PLUGS ONLY IN MAJOR MANUFACTURERS KEYWAYS SATIN CHROME FINISH, DRILLED 6 PIN



IL-15316CA-26D	A1001EH
IL-15316SX-26D	1145L
IL-15316WE-26D	1054WB

DUMMY MORTISE CYLINDERS

IL-7150DC-03	15/16"	BRASS
IL-7150DC-13	15/16"	DURODONIC
IL-7150DC-28	15/16"	ALUMINUM



CYLINDER PARTS



861B

IL-861B-26D-41

KABA CYLINDER GUARD RING (SATIN CHROME)

IL-861B-46-41

KABA CYLINDER GUARD RING (AMBER FINISH)

IL-861D-28-10

KABA SPACING COLLAR FOR MORTISE CYLINDERS (1/8")

IL-861E-28-10

KABA SPACING COLLAR FOR MORTISE CYLINDERS (5/32")

IL-861F-28-10

KABA SPACING COLLAR FOR MORTISE CYLINDERS (1/4")



862

IL-862-00-10

ILCO 1-3/4 CYLINDER BAR (RIM CYLINDER TAILPIECE)



862A

IL-862A-00-10

ILCO 2-3/8 CONNECTING BAR (RIM CYLINDER TAILPIECE)

2
Adams Rite
(863A)



IL-863A-00-10

ILCO ADAMS RITE CAM ONLY FOR 7165-7185 MORTISE CYLINDERS

1
Standard
(863G)



IL-863G-00-10

ILCO STANDARD CAM FOR 7165-7185 MORTISE CYLINDERS

15
Schlage L
(863M)



IL-863M-00-10

KABA-ILCO SCHLAGE L CAM FOR 7165-7165 MORTISE CYLINDERS

16
Sargent/Yale
(863N)



IL-863N-00-10

KABA-ILCO SARGENT CAM FOR 7165-7185 MORTISE CYLINDERS

7
Sargent Offset
(863U)



IL-863U-00-10

KABA-ILCO MORTISE CYLINDER CAM (SARGENT OFFSET)

CYLINDERS

CAPTIVE THUMBTURN MORTISE CYLINDERS, THUMBTURN COMES OUT!

IL-41671SX2-26D-KD	CAPTIVE THUMBTURN 1-1/8", C-K KEYWAY
IL-41671WA2-03-KD	CAPTIVE THUMBTURN 1-1/8", WR5 KEYWAY



THUMBTURN MORTISE CYLINDERS

IL-7161TK2-03	1" THUMBTURN MORTISE CYLINDER, POLISHED BRASS
IL-7161TK2-13	1" THUMBTURN MORTISE CYLINDER, DURADONIC
IL-7161TK2-26D	1" THUMBTURN MORTISE CYLINDER, SATIN CHROME
IL-7181TK1-26D	1-1/8" THUMBTURN MORTISE CYLINDER, YALE CAM, SATIN CHROME
IL-ADA7181TK2-26D	1-1/8 THUMBTURN WITH LARGE HANDICAP TURNPIECE



SFIC CYLINDER HOUSINGS



Machined solid brass cylinders for longer life, highest quality, Solid brass, accepts 6 or 7 pin Ilco cores or cores from Arrow, Best, Falcon, KSP

IL-R28106-0-26D	KABA IC MORTISE/RIM HOUSING LESS CAM (FOR 6 PIN IC)
IL-R28107-0-26D	KABA IC MORTISE/RIM HOUSING LESS CAM (FOR 7 PIN IC)
IL-R2800-CONVERSION-KIT	KABA RIM CYLINDER CONVERSION KIT FOR 28106/28107



REPLACEMENT CAMS FOR KABA/ILCO SFIC CYLINDER HOUSINGS

IL-R2800A#2-00-10	KABA ADAMS RITE CAM FOR 28106/28107 IC CYLINDER
IL-R2800G#1-00-10	KABA STANDARD YALE CAM FOR 28106/28107 IC CYLINDER
IL-R2800M#4-00-10	KABA SCHLAGE L CAM FOR 28106/28107 IC CYLINDER
IL-R2800N#5-00-10	KABA SARGENT/YALE CAM FOR 28106/28107 IC CYLINDER
IL-R2800S#3-00-10	KABA CLOVERLEAF CAM FOR 28106/28107 IC CYLINDER



LORI MORTISE DEADBOLTS

Standard Design, Single & Double Cylinder, 2-3/4 Inch backset.
Heavy Duty Strike. Satin Chrome and Brass finish. Less Cylinder.



- | | |
|----------------------------|--|
| IL-4514-04-03-5-2-5-SC-KD | SINGLE CYLINDER DEADBOLT (BRIGHT BRASS) |
| IL-4514-04-26D-5-2-5-SC-KD | SINGLE CYLINDER DEADBOLT (SATIN CHROME) |
| IL-4514-04-26D-0-LESS CYL | SINGLE CYLINDER DEADBOLT (LESS CYLINDER) |
| IL-4524-04-03-5-2-5-SC-KD | DOUBLE CYLINDER DEADBOLT (BRIGHT BRASS) |
| IL-4524-04-26D-5-2-5-SC-KD | DOUBLE CYLINDER DEADBOLT (SATIN CHROME) |
| IL-4500-03-5000 | 2-3/8" BACKSET BOLT FOR 4500 DEADBOLT |
| IL-4510-03-5001 | 2-3/4" BACKSET BOLT FOR 4500 SERIES DEADBOLT |
| IL-4550-03-5001 | 2-3/4" DRIVE-IN BOLT ONLY FOR 4500 SERIES |

JIMMYPROOFS, DEADLOCKS, RIMS AND NIGHT LATCHES

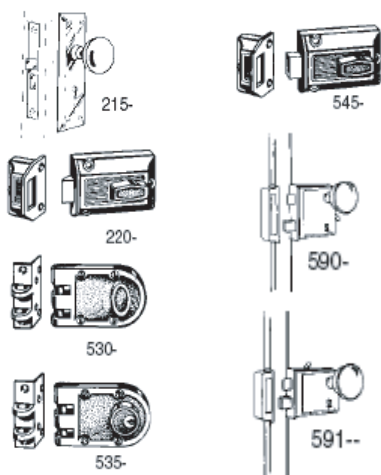

- | | |
|---------------|-------------------------------------|
| IL-215-04-51 | MORTISE LOCKSET |
| IL-220-53-51 | NIGHT LATCH, ROSE GOLD |
| IL-507 -54-51 | DOUBLE CYLINDER DEADBOLT |
| IL-530-53-51 | SINGLE CYLINDER JIMMYPROOF DEADLOCK |
| IL-535-53-51 | DOUBLE CYLINDER JIMMYPROOF DEADLOCK |
| IL-545-53-51 | RIM DEADLOCK |
| IL-590-04-51 | RIM LOCKSET - VERTICAL STYLE |
| IL-591-04-51 | RIM LOCKSET- HORIZONTALSTYLE |

REPLACEMENT DOOR KNOBS AND ACCESSORIES

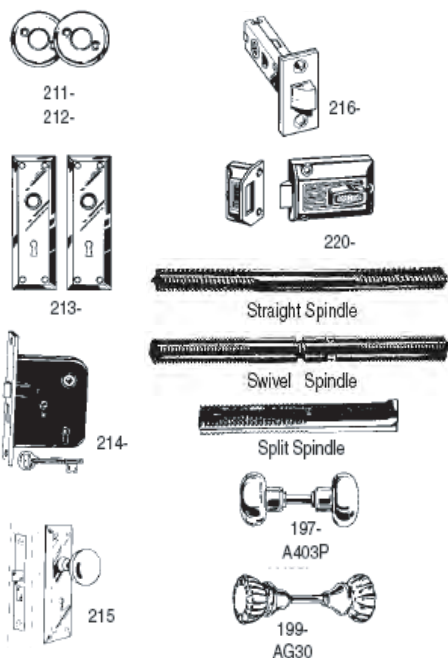

- | | |
|--------------|-------------------------------|
| IL-211-03-51 | ROSE FOR 199 OR AG30 KNOBS |
| IL-212-03-51 | ROSE FOR 197 OR A403P KNOBS |
| IL-213-04-51 | ESCUTCHEON PLATES |
| IL-215-04-51 | MORTISE LOCK SET |
| IL-214-04-51 | MORTISE LOCK REPLACEMENT |
| IL-216-03-51 | REPLACEMENT LATCH 220 |
| IL-220-53-51 | NIGHT LATCH |
| IL-760-05 | 3 1/2" STRAIGHT SPINDLE |
| IL-760-06 | 4 1/2" STRAIGHT SPINDLE |
| IL-760-07 | 4 1/2" SWIVEL SPINDLE |
| IL-760-11 | 3 1/4" SPLIT SPINDLE |
| IL-766-00-51 | 3 5/8" SPINDLE |
| IL-767-00-51 | 4 1/2" SPINDLE |
| IL-A403P | REPLACEMENT BRASS ROUND KNOBS |
| IL-AG30 | REPLACEMENT GLASS KNOBS |

PATIO DOOR LOCKS

300



IL-300-59-51

PATIO DOOR LOCK

AUXILIARY LOCKS



IL-5051-03-51

KEYED MORTISE BOLT

KEY ACCESSORIES



IL-1KC

IL-1KT

IL-2KT

IL-3KT

IL-261

IL-262

IL-264

IL-265

IL-266

IL-267

IL-268

BEADED KEY CHAIN

BRASS KEY TAG 1 1/4"

BRASS KEY TAG 1"

BRASS KEY TAG 3/4"

5/8" SPLIT KEY RINGS

3/4" SPLIT KEY RINGS

1" SPLIT KEY RINGS

1 1/8" SPLIT KEY RINGS

1 1/4" SPLIT KEY RINGS

1 1/2" SPLIT KEY RINGS

2" SPLIT KEY RINGS

SPECIALTY LOCKS

510



247

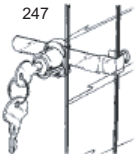

4067



1600



1650

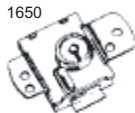

752MBL

980



990



IL-110-14-51

IL-247-26-51

IL-247-26-51 K A

IL-4067 -03-11 KA

IL-4067 -03-51

IL-4067-14-11 KA

IL-752MBL

IL-1600-04-11

IL-1650-04-11

IL-980-03-51

IL-990-14-51

5/8" CAM LOCK

SHOW CASE LOCK

SHOW CASE LOCK

DRAWER LOCK

DRAWER LOCK

DRAWER LOCK

MAILBOX LOCK (DOMINION)

LORI MAILBOX LOCK

LORI MAILBOX LOCK

DRAWER LOCK (BRASS - CARDED)

BYPASS LOCK (NICKEL - CARDED)

PROTECT-A-LOK

Finally a product designed to protect locks and other hardware from impact damage. The Keedex K-12 Protect-A-Lok, made from Lexan polycarbonate, is virtually indestructible. Designed for use in areas where locks may have a chance of getting hit by carts, forklifts or vehicles. Can be used with levers, knobs, panic hardware and more. Installs in minutes. Guaranteed for 5 years.

Used in:

- Hospitals
- Hotels
- Restaurants
- Schools
- Super Markets
- Warehouses
- And More

Use for Protecting:

- Locks
- Levers
- Panic Hardware
- Safe Dials and Handles
- Fire Alarm Equipment
- Access Control Equipment
- And More

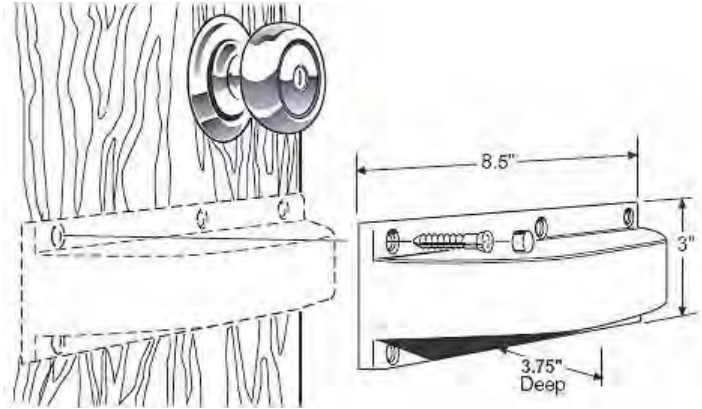

KX-K12-D KNOB PROTECTOR (DURANODIC)

CYLINDER GUARD RINGS

HARDENED STEEL-FREE SPINNING-TAPERED
CONE-SHAPED CYLINDER GUARD RING
PROTECTS MORTISE & RIM CYLINDERS



- KX-K24-L-A LARGE CYLINDER, POWDER COATED ALUMINUM
- KX-K24-L-B LARGE CYLINDER, POWDER COATED DURANODIC
- KX-K-24A STEEL-FREE SPINNING RING (ALUMINUM)(BAG/6)
- KX-K-24B STEEL-FREE SPINNING RING (DURANODIC)(BAG/6)

LEVER OPENING TOOL

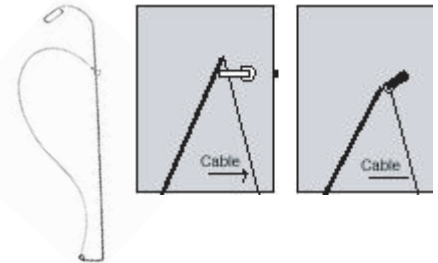

KX-K-22 LEVER OPENING TOOL

WELDABLE GATE BOXES

- KX-BXES3A KEEDEX WELDABLE BOX FOR ADAMS RITE 7100,7101,7140
- KX-BXMOR-1 KEEDEX WELDABLE MORTISE LOCK BOX-SCHLAGE/YALE/SARGENT
- KX-BXSG234 KEEDEX LOCK BOX SINGLE, 2 3/4 BACKSET, 2 1/8 HOLE
- KX-BXSIM-4000 KEEDEX WELDABLE GATE BOX FOR SIMPLEX 4000 SERIES
- KX-BXSIM-EE KEEDEX WELDABLE GATE BOX FOR UNICAN (EE1000 SERIES)
- KX-BXSIM KEEDEX WELDABLE BOX 1000 SERIES/ALARM LOCK TRILOGY
- KX-K-BXA/R-1-1/8 KEEDEX WELDABLE GATE BOX FOR ADAMS RITE 4700/1850
- KX-K-BXA/R-31/32 KEEDEX WELDABLE BOX FOR ADAMS RITE 1850S/1851S/4511
- KX-KBXES5 KEEDEX WELDABLE ELECTRIC STRIKE BOX FOR HES 1006

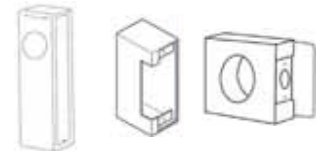

K-BXA/R BXES3A BXSG234



SAFE CHANGE KEYS

How many times have you searched and searched for a particular change key at the bottom of your tool box? Keedex has the solution. The K-18 Change Key Set is a set of the twelve most common change keys, all in a handy case. Keys fold out "knife style" to select the proper tool. Case is engraved with description of uses. Keys are made of stainless steel. Made in U.S.A.

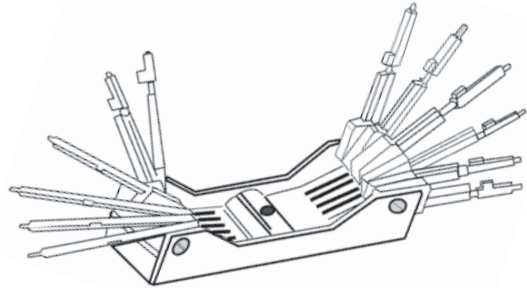

KX-K18 SAFE CHANGE KEY SET
KX-K16 SAFE REPAIR KIT

K-TMPA/R INSTALLATION TEMPLATE FOR ADAMS RITE

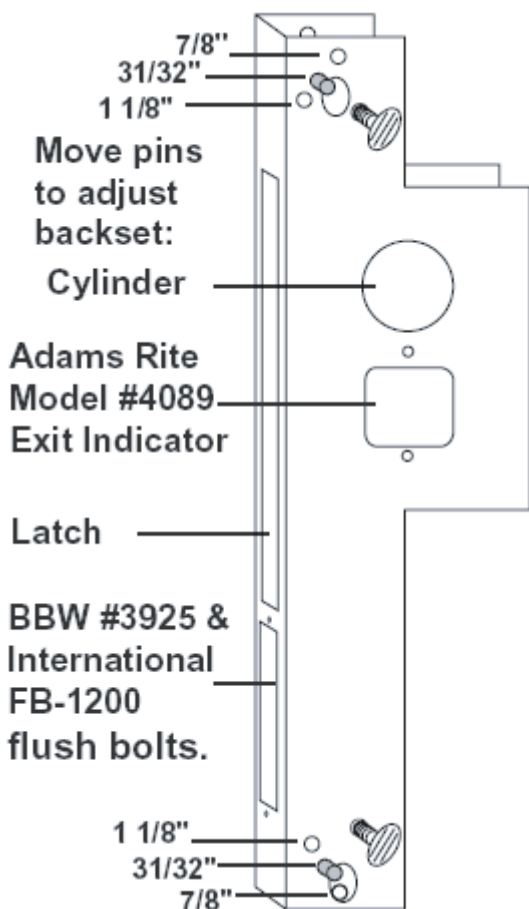

This tool allows you to make precise installation of Adams Rite 1850S, 4530, 4710 & 4711 series locks. Also works with the International DH 1822 & DL4511. Covers the following back sets: 7/8", 31/32" & 1 1/8". Includes guide for Adams Rite exit indicator #4089. Has cutout for BBW #3925 & International FB-1200 flush bolts.

This template is designed to be used with a 1/2" router guide with a 1/4" bit.

KX-TMPA/R ADAMS RITE INSTALLATION TEMPLATE

KEY & TRAVEL TAGS



KN-ID24BP Executags - 2



KN-ID4AC25 Travel Tag Assortment - 25



KN-ID5PP2 Plastic Key Tag-2 PACK

KEY TAGS



KN-ID9RTL Keytag Rack - 4 Tags



KN-ID6RTL Keytag Rack - 8 Tags



- KN-ID5AC100 Plastic Tag Assorted Colours - 100
- KN-ID5AC50-BLUE Plastic Key Tags - 50 Blue
- KN-ID5AC50-CLEAR Plastic Key Tags - 50 Clear
- KN-ID5AC50-YELLOW Plastic Key Tags - 50 Yellow
- KN-ID5AC50-ORANGE Plastic Key Tags - 50 Orange
- KN-ID5AC50-RED Plastic Key Tags - 50 Red
- KN-ID5AC50-GREEN Plastic Key Tags - 50 Green



KN-ID38AC60 ASSORTED COLOUR CLICK TAGS (60 PER CAN)



KN-ID5AC150 ASSORTED COLOUR CLICK TAGS (150 PER JAR)



KN-ID5ADP100 (150 PER JAR) PERSONALIZED ASSORTED COLOUR CLICK TAGS WITH YOUR COMPANY NAME ON THE BACK OF EVERY TAG



KEYSCAN ACCESS CONTROL

- **Emergency lockdown • Multi-site • Easy to use • Reliable • Expandable**
- Well featured yet easy to manage!**

Keyscan 2 Reader Control Panel **CA200**



Provides 256 timezones, 512 time schedules, 511 group levels and 64 holiday types and a 6000 transaction buffer.

Can be mixed and matched with any of Keyscan's family of controllers to create a system with an unlimited number of doors.

Flexible communication options including; TCP/IP LAN/WAN, Wireless LAN, Wireless Point to Point, RS485 and modem connectivity.

Keyscan 4 Reader Control Panel **CA4000**



Provides 256 timezones, 512 time schedules, 511 group levels and 64 holiday types and a 6000 transaction buffer.

Can be mixed and matched with any of Keyscan's family of controllers to create a system with an unlimited number of doors.

Flexible communication options including; TCP/IP LAN/WAN, Wireless LAN, Wireless Point to Point, RS485 and modem connectivity.

Provides impressive I/O expansion with the IOCB1616

Keyscan 8 Reader Control Panel **CA8000**



Provides 256 timezones, 512 time schedules, 511 group levels and 64 holiday types and a 6000 transaction buffer.

Can be mixed and matched with any of Keyscan's family of controllers to create a system with an unlimited number of doors.

Flexible communication options including; TCP/IP LAN/WAN, Wireless LAN, Wireless Point to Point, RS485 and modem connectivity.

Provides impressive I/O expansion with the IOCB1616

Keyscan Elevator Control Systems **EC1000 & EC2000**



This 1 or 2 cab elevator controller can be mixed and matched with any of Keyscan's family of controllers to create a system with an unlimited number of doors and added elevator access controls.

Provides 256 timezones, 512 time schedules, 511 group levels and 64 holiday types and a 6000 transaction buffer.

Flexible communication options including; TCP/IP LAN/WAN, Wireless LAN, Wireless Point to Point, RS485 and modem connectivity.



KEYSCAN ACCESS CONTROL

- Emergency lockdown • Multi-site • Easy to use • Reliable • Expandable
- Well featured yet easy to manage!**

System VII Software **System VII**



Operates on Windows Vista Business, Windows 2000 and XP Pro
 Import/Export capabilities for card holders
 Multi-language capabilities (English, French and Spanish)
 Present 3 functionality for emergency facility lock down, time zone toggling, alarm panel integration, individual zone arming etc., at any system reader in case of a security threat
 32,000 card holders per site; with unlimited sites
 Disaster recovery utility for added insurance to retrieve site data from control units in the event of computer or hard disk failure
 Scheduled database backup utility
 Full system logging for audit & report generation

System VII CCTV Module **K-TV**



CCTV add-on module for System VII provides integration with many of the industry leading DVRs in the market.
 Contact Keyscan for details.
 Call up live video or alarm event video through System VII with just a click of a button.
 View CCTV cameras and historical events through one software package
 Configure desired alarms to trigger an associated CCTV camera pop up window
 Tag alarm events in the DVR for timely DVR event searches

System VII Photo Badging Module **K-BADGE**



Photo badging add-on module for System VII allows you to assign photos to card holders. Conveniently ties in and integrates photo badging within the access control system.
 Provides a extra layer of security to visually verify cardholder identities
 Create corporate badges
 Print Corporate badges with the VBP408 or VBP408DBL ISO card printers

System VII Visitor Management Module **K-VIS**



Integrate visitor management with the access control system.
 Assign visitors with limited visitor access privileges.
 Provide email notification of visitor arrivals
 Track visitors arrival and departure times
 Retain historical records of visitors
 Add a business card scanner (BIZSCAN) for increased efficiency.



KEYSCAN ACCESS CONTROL

- **Emergency lockdown** • **Multi-site** • **Easy to use** • **Reliable** • **Expandable**
- Well featured yet easy to manage!**



RS-485 Communication Board **CB-485**

RS-485 Communication board – one board required per ACU when 2 or more ACUs are communicating to the PC
Uses CAT5 cable (2 twisted pairs)
Maximum wiring distance between control units is 2000' (600m)
Provides reliable communications



Network Communication Plug On Board **NETCOM2P**

This plug on TCP/IP communication adapter provides network connectivity for the CB485 communication board.
Delivers multiple ACU communication to PC over a LAN/WAN (TCP/IP)
Plugs into socket on CB-485
Suitable for 10/100 Ethernet/Fast Ethernet applications
Uses static IP address



Network Communication Interface **NETCOM2**

Ideal for providing TCP/IP LAN/WAN connectivity for a single ACU.
Uses a Static IP
Suitable for 10/100 Ethernet/Fast Ethernet applications



Wireless Network Communication Board **NETCOM2WH**

Provides Wireless LAN or Wireless Point to Point configuration for Keyscan's control panels.
Compatible with 802.11b and 802.11g protocols.
Provides an indoor wireless range of up to 328 feet (100m)
Suitable for WLAN multipoint connectivity



Wireless Receiver **RXPROX**

Ideal for securing and integrating parking gates and garage doors with access control systems
Wireless receiver works with Keyscan's TX2PRX and TX4PRX family of transmitters.
Provides a read range of up to 100' (30m)
RXPROX provides a wiegand output for integration with access control panels



Wireless Transmitters

TX2PRX/TX4PRX (HID)

INTX2PRX/INTX4PRX (Indala)

TX2iCLASS/TX4iCLASS (HID iCLASS)



Key fobs work in conjunction with the RXPROX receiver.

Provide wireless transmission as well as operate as a regular card or tag at HID, iClass, INDALA card readers.

Key fobs provide 100' to (30m) wireless range with the RXPROX receiver

Operates as a regular card or tag when presented to readers

Code hopping encoding

2 and 4 button key fobs available to control multiple garage doors or gates.

Keyscan Proximity Reader

K-PROX2



Keyscan's KPROX2 125kHz prox reader provides a mullion mount reader with a stylish molded single gang mounting plate.

Compatible with HID 125kHz prox cards over a wide range of bit structures

Suitable for indoor and outdoor use

Read range up to 6"

Extremely reliable and cost effective

Limited lifetime warranty against defects in materials and workmanship

Keyscan Proximity Reader/Keypad

K-KPR



For an extra layer of security when Pin and Prox is desired use this stylish and reliable keypad/prox reader.

Blue backlit keys for low light use

Tactile and audible tone to indicate key presses.

Utilizes one reader port

Limited lifetime warranty against defects in materials and workmanship

Keyscan Vandal Resistant Proximity Reader

K-VAN



When installing readers in harsh environments where vandalism is a threat, use this vandal resistant reader to provide added durability and peace of mind.

Solid stainless steel bezel with Fibertex® insert provides the highest level of vandal resistance

Fibertex® material is UL752 listed for bulletproof integrity

May be used on non-Keyscan systems with a wide range of HID 125kHz card bit structures

Pass-thru Wiegand output standard

Suitable for outdoor applications in all weather

Limited lifetime warranty against defects in materials and workmanship

660 SERIES DEADBOLTS



The Single cylinder deadbolt 660 provides tough, effective protection at an affordable price. It is equipped with a full 1" throwbolt.

ANSI/BHMA A156.2 Grade 3 Security

KW-660-605-L03	SINGLE CYLINDER DEADBOLT, BRASS-LIFETIME FINISH
KW-660-626	SINGLE CYLINDER DEADBOLT, SATIN CHROME
KW-665-605	DOUBLE CYLINDER DEADBOLT, BRASS
KW-81467	CYLINDER REMOVAL TOOL

BORING JIG INSTALLATION KIT

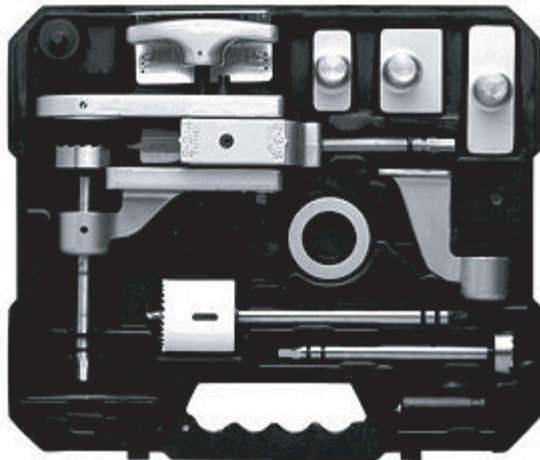

KW-138

All In One Boring Jig - Quick Boring System
Drills wood and metal Doors
Drills 2-1/8 and 1-1/2" door prep
Tool-free backset adjustment
Change Bits without re-chucking

Tool-free backset adjusts with simple twist!



Ergonomic handle design



PIN TWEEZERS



LA-LZT001 LAB FORMED END TWEEZER CORES

PLUG FOLLOWERS

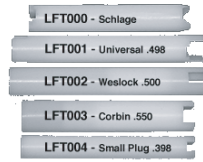

LA-LFT005 PLUG FOLLOWER SET

I/C PINNING BLOCK



LA-LICCB LAB I/C CORE CAPPING BLOCK

MEDECO GAUGE

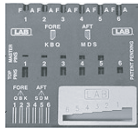

LA-LPDMED MEDECO PIN DECODER AND KEY GAUGE FOR BIAxIAL

SCHLAGE ORIGINAL PIN KIT



LA-SPK115 SCHLAGE PIN KIT

Constructed of Heavy-Duty Steel
Leakproof Seal-Tight Cover.
10 Nickel-Silver Bottom Pins #0-9
8 Brass Master Pins #2-9
3 Brass Top Pins #1-3
Cylinder Cap Pins & Cap Pin Springs
Cylinder Springs (C503-113)

UNIVERSAL PIN KITS

DUR-X SEMI PRO



Light weight and made of super tough polyethylene. Triple latches with double snap protection. Center lid carrying handle. Seal-Tight Lid prevents pins from mixing.

.003 Increments
124 Pin sizes, 1 Spring size
Master Pins sizes: .010 - .200
Bottom sizes: .156 - .360
LA-LDKU3

.005 Increments
102 Sizes, 1 Spring size
Master Pins sizes: .010 - .300
Bottom sizes: .150 - .360
LA-LDKZ5
LA-LDK005 WITH DRAWER

CLASSIC PRO



Solid metal construction. The most durable kit you can buy. Seal-Tight Lid prevents pins from mixing

.003 Increments
124 Pin sizes, 1 Spring size
Master Pins sizes: .010 - .200
Bottom sizes: .156 - .360
LA-LPK003

.005 Increments
102 Sizes, 1 Spring size
Master Pins sizes: .010 - .300
Bottom sizes: .150 - .360
LA-LPK005

MINI UNIVERSAL



Solid metal construction. The most durable kit you can buy. Seal-Tight Lid prevents pins from mixing
Dimensions: 8"x6"x11/16"

.003 Increments
81 Sizes - No Unnecessary Sizes
Masters: .024 - .090
Drivers: .093 - .235
Bottoms: .156 - .354
.115 Long Cylinder Springs
LA-LMK003

.005 Increments
81 Sizes - No Unnecessary Sizes
Masters: .010 - .090
Drivers: .095 - .200
Bottoms: .155 - .360
.115 Long Cylinder Springs
LA-LMK005



**UNIVERSAL
I/C CORE PINS**

Services all I/C Cores using Brass Keys
Constructed of Heavy-Duty Steel
10 Brass Color-Coded Bottom Pins #0-9
18 Brass Master/Top Pins #2-19
Spring Caps, 2 Styles Machined and Stamped
Spring Covers for 6 & 7 Pin Cores
2 Different Length Springs



LA-BFK108

INTERCHANGEABLE CORE PINS (SFIC) .108 Diameter

- . For use in: Falcon, Best, Arrow and Eagle
- . Colour Coded Brass PiM
- . Exact Manufacturer's sizes and specifications

Order No.	Description	Order No.	Description	Order No.	Description
LA-108-013-1T	.108 x .013-1T Top	LA-108-122-1B	.108 x .122-1B Bottom	LA-108-185-6B	.108 x .185-6B Bottom
LA-108-025-2T	.108 x .025-2T Top	LA-108-125-10T	.108 x .125-10T Top	LA-108-187-15T	.108 x .187-15T Top
LA-108-037-3T	.108 x .037-3T Top	LA-108-135-2B	.108 x .135-2B Bottom	LA-108-197-7B	.108 x .197-7B Bottom
LA-108-050-4T	.108 x .050-4T Top	LA-108-137-11T	.108 x .137-11T Top	LA-108-200-16T	.108 x .200-16T Top
LA-108-062-5T	.108 x .062-5T Top	LA-108-147-3B	.108 x .147-3B Bottom	LA-108-210-8B	.108 x .210-88 Bottom
LA-108-075-6T	.108 x .075-6T Top	LA-108-150-12T	.108 x .150-12T Top	LA-108-212-17T	.108 x .212-17T Top
LA-108-087-7T	.108 x .087-7T Top	LA-108-160-4B	.108 x .160-4B Bottom	LA-108-222-9B	.108 x .222 -9B Bottom
LA-108-100-8T	.108 x .100-8T Top	LA-108-162-13T	.108 x .162-13T Top	LA-108-225-18T	.108 x .225-18T Top
LA-108-110-0B	.108 x .110-0B Bottom	LA-108-172-5B	.108 x .172-5B Bottom	LA-108-237-19T	.108 x .237-19T Top
LA-108-112-9T	.108 x .112-9T Top	LA-108-175-14T	.108 x .175-14T Top		

ALL LAB UNIVERSAL TUMBLER PINS COME IN REUSABLE FLIP TOP VIALS

PIN COVERS



LA-FSC6 FALCON PIN Covers
LA-I027 BEST-ARROW CAPS FOR I/C

SPRINGS AND SHIMS



LA-108F Interchangeable core springs
LA-115L .115 Long Springs
LA-115S .115 Short Springs
LA-LSMO-25 Curved shims (25 pack)

PINNING BLOCK



LA-LPB001 Pin block made of apple wood,
5 plug availability,
Rubber bump-ons,
Use with fingers or tweezers.

5-IN-1 KEY GUAGE



LA-LKG001
For Kwikset, Schlage, Weiser,
Weslock, and Master
Small size (3-3/8" x 2-1/8")

CAP REMOVER

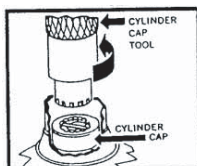

LA-LCR005
PRO CYLINDER CAP REMOVER
FOR SCHLAGE/WEISER

MISC. TOOLS



LA-LABLIGHT
LA-LABMAT



EAR LIGHT (LED LIGHT)
RUBBER PINNING MAT

UNIVERSAL TUMBLER PINS



Most accurate Universal pin made.
Use with confidence of Original pins.
Top : .024 to .141
Bottom: .126 to .360
Flat Centre

Perfectly parallel
Radius edges that blend into flat centre
Master pins will not tip or roll
Colour Coded

Order No.	Description	Order No.	Description	Order No.	DescripUon
LA-003-024T	.003 x .024 Top	LA-003-135B	.003 x .135 Bottom	LA-003-246B	.003 x .246 Bottom
LA-003-027T	.003 x .027 Top	LA-003-135T	.003 x .135 Top	LA-003-249B	.003 x .249 Bottom
LA-003-030T	.003 x .030 Top	LA-003-138B	.003 x .138 Bottom	LA-003-252B	.003 x .252 Bottom
LA-003-033T	.003 x .033 Top	LA-003-138T	.003 x .138 Top	LA-003-255B	.003 x .255 Bottom
LA-003-036T	.003 x .036 Top	LA-003-141B	.003 x .141 Bottom	LA-003-258B	.003 x .258 Bottom
LA-003-039T	.003 x .039 Top	LA-003-141T	.003 x .141 Top	LA-003-261B	.003 x .261 Bottom
LA-003-042T	.003 x .042 Top	LA-003-144B	.003 x .144 Bottom	LA-003-264B	.003 x .264 Bottom
LA-003-045T	.003 x .045 Top	LA-003-147B	.003 x .147 Bottom	LA-003-267B	.003 x .207 Bottom
LA-003-048T	.003 x .048 Top	LA-003-150B	.003 x .150 Bottom	LA-003-270B	.003 x .270 Bottom
LA-003-051T	.003 x .051 Top	LA-003-153B	.003 x .153 Bottom	LA-003-273B	.003 x .273 Bottom
LA-003-054T	.003 x .054 Top	LA-003-156B	.003 x .156 Bottom	LA-003-276B	.003 x .276 Bottom
LA-003-057T	.003 x .057 Top	LA-003-159B	.003 x .159 Bottom	LA-003-279B	.003 x .279 Bottom
LA-003-060T	.003 x .060 Top	LA-003-162B	.003 x .162 Bottom	LA-003-282B	.003 x .282 Bottom
LA-003-063T	.003 x .063 Top	LA-003-165B	.003 x .165 Bottom	LA-003-285B	.003 x .285 Bottom
LA-003-066T	.003 x .066 Top	LA-003-168B	.003 x .168 Bottom	LA-003-288B	.003 x .288 Bottom
LA-003-069T	.003 x .069 Top	LA-003-171B	.003 x .171 Bottom	LA-003-291B	.003 x .291 Bottom
LA-003-072T	.003 x .072 Top	LA-003-174B	.003 x .174 Bottom	LA-003-294B	.003 x .294 Bottom
LA-003-075T	.003 x .075 Top	LA-003-177B	.003 x .177 Bottom	LA-003-297B	.003 x .297 Bottom
LA-003-078T	.003 x .078 Top	LA-003-180B	.003 x .180 Bottom	LA-003-300B	.003 x .300 Bottom
LA-003-081T	.003 x .081 Top	LA-003-183B	.003 x .183 Bottom	LA-003-303B	.003 x .303 Bottom
LA-003-084T	.003 x .084 Top	LA-003-186B	.003 x .186 Bottom	LA-003-306B	.003 x .306 Bottom
LA-003-087T	.003 x .087 Top	LA-003-189B	.003 x .189 Bottom	LA-003-309B	.003 x .309 Bottom
LA-003-090T	.003 x .090 Top	LA-003-192B	.003 x .192 Bottom	LA-003-312B	.003 x .312 Bottom
LA-003-093T	.003 x .093 Top	LA-003-195B	.003 x .195 Bottom	LA-003-315B	.003 x .315 Bottom
LA-003-096T	.003 x .096 Top	LA-003-198B	.003 x .198 Bottom	LA-003-318B	.003 x .318 Bottom
LA-003-099T	.003 x .099 Top	LA-003-201B	.003 x .201 Bottom	LA-003-321B	.003 x .321 Bottom
LA-003-102T	.003 x .102 Top	LA-003-204B	.003 x .204 Bottom	LA-003-324B	.003 x .324 Bottom
LA-003-105T	.003 x .105 Top	LA-003-207B	.003 x .207 Bottom	LA-003-327B	.003 x .327 Bottom
LA-003-108T	.003 x .108 Top	LA-003-210B	.003 x .210 Bottom	LA-003-330B	.003 x .330 Bottom
LA-003-111T	.003 x .111 Top	LA-003-213B	.003 x .213 Bottom	LA-003-333B	.003 x .333 Bottom
LA-003-114T	.003 x .114 Top	LA-003-216B	.003 x .216 Bottom	LA-003-336B	.003 x .336 Bottom
LA-003-117T	.003 x .117 Top	LA-003-219B	.003 x .219 Bottom	LA-003-339B	.003 x .339 Bottom
LA-003-120T	.003 x .120 Top	LA-003-222B	.003 x .222 Bottom	LA-003-342B	.003 x .342 Bottom
LA-003-123T	.003 x .123 Top	LA-003-225B	.003 x .225 Bottom	LA-003-345B	.003 x .345 Bottom
LA-003-126B	.003 x .126 Bottom	LA-003-228B	.003 x .228 Bottom	LA-003-348B	.003 x .348 Bottom
LA-003-126T	.003 x .126 Top	LA-003-231B	.003 x .231 Bottom	LA-003-351B	.003 x .351 Bottom
LA-003-129B	.003 x .129 Bottom	LA-003-234B	.003 x .228 Bottom	LA-003-354B	.003 x .354 Bottom
LA-003-129T	.003 x .129 Top	LA-003-237B	.003 x .234 Bottom	LA-003-357B	.003 x .357 Bottom
LA-003-132B	.003 x .132 Bottom	LA-003-240B	.003 x .240 Bottom	LA-003-360B	.003 x .360 Bottom
LA-003-132T	.003 x .132 Top	LA-003-243B	.003 x .243 Bottom		

**UNIVERSAL
TUMBLER PINS**

OrderNo.	Description
LA-005-010T	.005 x .010 Top
LA-005-015T	.005 x .015 Top
LA-005-020T	.005 x .020 Top
LA-005-025T	.005 x .025 Top
LA-005-030T	.005 x .030 Top
LA-005-035T	.005 x .035 Top
LA-005-040T	.005 x .040 Top
LA-005-045T	.005 x .045 Top
LA-005-050T	.005 x .050 Top
LA-005-055T	.005 x .055 Top
LA-005-060T	.005 x .060 Top
LA-005-065T	.005 x .065 Top
LA-005-070T	.005 x .070 Top
LA-005-075T	.005 x .075 Top
LA-005-080T	.005 x .080 Top
LA-005-085T	.005 x .085 Top
LA-005-090T	.005 x .090 Top
LA-005-095T	.005 x .095 Top
LA-005-100T	.005 x .100 Top
LA-005-105T	.005 x .105 Top
LA-005-110T	.005 x .110 Top
LA-005-115B	.005 x .115 Bottom
LA-005-115T	.005 x .115 Top
LA-005-120B	.005 x .120 Bottom
LA-005-120T	.005 x .120 Top
LA-005-125B	.005 x .125 Bottom
LA-005-125T	.005 x .125 Top
LA-005-130B	.005 x .130 Bottom
LA-005-130T	.005 x .130 Top
LA-005-135B	.005 x .135 Bottom
LA-005-135T	.005 x .135 Top
LA-005-140B	.005 x .140 Bottom
LA-005-140T	.005 x .140 Top
LA-005-145B	.005 x .145 Bottom
LA-005-145T	.005 x .145 Top
LA-005-150B	.005 x .150 Bottom
LA-005-150T	.005 x .150 Top
LA-005-155B	.005 x .155 Bottom
LA-005-155T	.005 x .155 Top
LA-005-160B	.005 x .160 Bottom
LA-005-160T	.005 x .160 Top
LA-005-165B	.005 x .165 Bottom
LA-005-165T	.005 x .165 Top
LA-005-170B	.005 x .170 Bottom
LA-005-170T	.005 x .170 Top
LA-005-175B	.005 x .175 Bottom
LA-005-175T	.005 x .175 Top
LA-005-180B	.005 x .180 Bottom
LA-005-180T	.005 x .180 Top

- .005
- . Top: .010 to .320
- . Bottom: .115 to .360
- . Flat Centre. Master pins seat squarely
- . Perfectly parallel
- . Precision machined chamber, length and nose
- . Colour coded



Order No.	Description	Order No.	Description
LA-005-185B	.005 x .185 Bottom	LA-005-265B	.005 x .265 Bottom
LA-005-185T	.005 x .185 Top	LA-005-265T	.005 x .265 Top
LA-005-190B	.005 x .190 Bottom	LA-005-270B	.005 x .270 Bottom
LA-005-190T	.005 x .190 Top	LA-005-270T	.005 x .270 Top
LA-005-195B	.005 x .195 Bottom	LA-005-275B	.005 x .275 Bottom
LA-005-195T	.005 x .195 Top	LA-005-275T	.005 x .275 Top
LA-005-200B	.005 x .200 Bottom	LA-005-280B	.005 x .280 Bottom
LA-005-200T	.005 x .200 Top	LA-005-280T	.005 x .280 Top
LA-005-205B	.005 x .205 Bottom	LA-005-285B	.005 x .285 Bottom
LA-005-205T	.005 x .205 Top	LA-005-285T	.005 x .285 Top
LA-005-210B	.005 x .210 Bottom	LA-005-290B	.005 x .290 Bottom
LA-005-210T	.005 x .210 Top	LA-005-290T	.005 x .290 Top
LA-005-215B	.005 x .215 Bottom	LA-005-295B	.005 x .295 Bottom
LA-005-215T	.005 x .215 Top	LA-005-295T	.005 x .295 Top
LA-005-220B	.005 x .220 Bottom	LA-005-300B	.005 x .300 Bottom
LA-005-220T	.005 x .220 Top	LA-005-300T	.005 x .300 Top
LA-005-225B	.005 x .225 Bottom	LA-005-305B	.005 x .305 Bottom
LA-005-225T	.005 x .225 Top	LA-005-305T	.005 x .305 Top
LA-005-230B	.005 x .230 Bottom	LA-005-310B	.005 x .310 Bottom
LA-005-230T	.005 x .230 Top	LA-005-310T	.005 x .310 Top
LA-005-235B	.005 x .235 Bottom	LA-005-315B	.005 x .315 Bottom
LA-005-235T	.005 x .235 Top	LA-005-315T	.005 x .315 Top
LA-005-240B	.005 x .240 Bottom	LA-005-320B	.005 x .320 Bottom
LA-005-240T	.005 x .240 Top	LA-005-320T	.005 x .320 Top
LA-005-245B	.005 x .245 Bottom	LA-005-325B	.005 x .325 Bottom
LA-005-245T	.005 x .245 Top	LA-005-330B	.005 x .330 Bottom
LA-005-250B	.005 x .250 Bottom	LA-005-335B	.005 x .335 Bottom
LA-005-250T	.005 x .250 Top	LA-005-340B	.005 x .340 Bottom
LA-005-255B	.005 x .255 Bottom	LA-005-345B	.005 x .345 Bottom
LA-005-255T	.005 x .255 Top	LA-005-350B	.005 x .350 Bottom
LA-005-260B	.005 x .260 Bottom	LA-005-355B	.005 x .355 Bottom
LA-005-260T	.005 x .260 Top	LA-005-360B	.005 x .360 Bottom

1070 SERIES

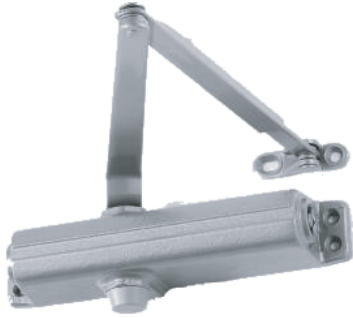

The 1070 is a cast iron closer that fits the most common commercial footprint. This economical closer is designed for use on narrow 1 3/4" head frames. The 1070 Series is UL and ULC listed for self-closing doors without holdopen. Tested and certified under ANSI Standard A156.4, grade one.

LC-1071-689 DOOR CLOSER, 689 - ALUMINUM
 LC-1075-689 DOOR CLOSER, 689 - ALUMINUM

1460 SERIES



The 1460 SUPER STOCK is a fully universal double lever arm, slim line closer designed for use on narrow head frames and top rails. A wide choice of options, mounting accessories and ease of installation offer maximum versatility.

LC-1461-689-FAST ALUMINUM FINISH
 LC-1461-DA-689 DURODONIC FINISH / DELAYED ACTION
 LC-1461-H-689 ALUMINUM FINISH / HOLD OPEN
 LC-1461-695(DURO) DOOR CLOSER, DURODONIC
 LC-1461-CUSH-689 DOOR CLOSER WITH CUSH-N-STOP

1371 QUEST



A universal closer for aluminum store fronts. Quest has it all. Quest is non-handed and non-sized to give you maximum flexibility and power (adjustable up to 5 power). Right out of the carton, Quest is ready for mounting in record setting time on the pull side, push side or parallel arm. The Quest adapter plate is even sculpted to conform to the shape of the closer. For aluminum, hollow metal or wood doors and frames. Can be used with hinge or pivot mounted doors. Mounts on a 1-3/4in. transom without adapter plates.

LC-1371-689 ALUMINUM FINISH
 LC-1371-695 DURODONIC FINISH

The 1370 Series is UL and ULC listed for self-closing doors without hold-open.

2030 SERIES



The concealed 2030 Series PACER is a heavy duty closer designed to fit in a narrow 1 3/4" aluminum transom. The single lever arm and roller assembly provide smooth, quiet door control and the choice of finishes and track functions meet virtually all architectural requirements.

LC-2035-LH-689 LEFT HAND
 LC-2035-RH-689 RIGHT HAND

4010 SERIES

The 4010 SMOOTHIE is a heavy duty, double lever arm closer designed for institutional and other high traffic applications. This handed closer is specifically designed for hinge side mounting and has passed 10,000,000 cycles in independent testing. A choice of finishes, cylinder functions, arms, and installation accessories meet virtually all architectural requirements.

LC-4011-LH-689 LEFT HAND
LC-4011-RH-689 RIGHT HAND



4020 SERIES

The 4020 SMOOTHIE is a heavy duty, double lever arm closer designed for institutional and other high traffic applications. This handed closer is specifically designed for top-jamb mounting and has passed 10,000,000 cycles in independent testing. A choice of finishes, cylinder functions, arms, and installation accessories meet virtually all architectural requirements.

LC-4021LH-689 LEFT HAND
LC-4021RH-689 RIGHT HAND



4031 SERIES

LCN's new 4030 Series is now a universal closer available with heavy duty, forged steel arms, multiple arm options, standard metal cover and a peel and stick template for easy installation. The New 4030 even suites with the popular LCN 4040 Series Closer, giving you a good looking design for any application and budget.

LC-4031-689 4030 DOOR CLOSER (NON HANDED)

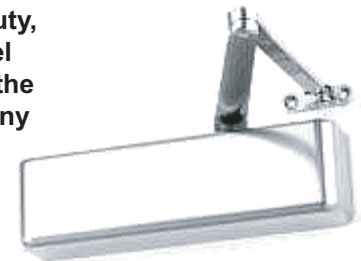

4040 SERIES

The 4040 SUPER SMOOTHIE is a heavy duty, double lever arm closer designed for institutional and other high traffic applications, and has passed 10,000,000 cycles in independent testing. The wide choice of options, installation accessories and ease of installation offer maximum versatility.

LC-4041-689 UNIVERSAL CLOSER
LC-4041-695 UNIVERSAL CLOSER
LC-4041-H-689 UNIVERSAL CLOSER WITH HOLD OPEN
LC-4041-H-CUSH-689 UNIVERSAL CLOSER WITH HOLD OPEN & CUSH-N-STOP
LC-4041-DA-689 UNIVERSAL CLOSER WITH DELAYED ACTION
LC-4041-689-EDA UNIVERSAL DOOR CLOSER, EXTRA DUTY ARM
LC-4041-CUSH-689 DOOR CLOSER WITH CUSH-N-STOP
LC-4041-SH-CUSH-689 DOOR CLOSER WITH SPRING HOLD OPEN AND CUSH N STOP



XP4040 SERIES

Product Features

- Strongest pinion ever at 3/4"
- Taller bearings – 5/8" to help against forced openings and closing
- An overall 44% increase in maximum load capacity
- Advanced V-shield sealing technology with 20% longer life
- Better wear resistance against sagging doors and warped frames
- Standard heavy-duty EDA forged steel arm
- XP = eXtra Protection in real-world applications



Standard Heavy-Duty EDA Forged Steel Arm

- Double Heat Treated Pinion
- Powder-Coated Finish
- All-Weather Fluid Reduces Seasonal Adjustments
- Fast Power Adjust
- Easy-To-Install Peel-And-Stick Template
- Meets ADA Requirements
- Same Hole Pattern As Standard 4040



LC-4040XP-689-62PA **XP SERIES 4040 DOOR CLOSER**

4040SE SERIES

The 4040SE SENTRONIC is a heavy duty, non-handed, nonsized closer/holder designed to provide single point hold-open for fire and smoke barrier doors. The door is held open until current interruption releases the holding mechanism and the door closes. Single lever (track) arm closer is specifically designed for interior doors. Choice of finishes, track functions, and installation accessories meet virtually all life safety requirements.

LC-4040SE-689-120VAC
LC-4040SE-689-24VAC



4110 SERIES

The 4110 SMOOTHIE is a heavy duty, parallel arm closer designed for institutional and other high traffic applications. This handed closer is specifically designed for parallel arm mounting and has passed 10,000,000 cycles in independent testing. The wide choice of options, installation accessories and ease of installation offer maximum versatility



LC-4111-RH-689	RIGHT HAND
LC-4111-LH-689	LEFT HAND
LC-4111-CUSH-LH-689	DOOR CLOSER (LEFT HAND/CUSH)
LC-4111-CUSH-RH-689	DOOR CLOSER (RIGHT HAND/CUSH)
LC-4111-H-CUSH-LH-689	DOOR CLOSER (HOLD OPEN/CUSH) (LEFT HAND)
LC-4111-H-CUSH-RH-689	DOOR CLOSER (HOLD OPEN/CUSH) (RIGHT HAND)
LC-4111-H-EDA-689-LH	DOOR CLOSER (HOLD OPEN)
LC-4111-LH-689	DOOR CLOSER (LEFT HAND) (EDA PARALLEL ARM)
LC-4111-RH-689	DOOR CLOSER (RIGHT HAND) (EDA PARALLEL ARM)
LC-4111-S-CUSH-689-LH	DOOR CLOSER (SPRING-CUSH)
LC-4111-S-CUSH-689-RH	DOOR CLOSER (SPRING-CUSH)

5010 SERIES

The concealed 5010 Series is a heavy duty closer designed for institutional, high traffic, or other applications exposed to weather or abuse. The double lever arm provides superior door control and a choice of finishes, cylinder functions, and arm functions meet virtually all architectural requirements.

LC-5014LH-689
LC-5014RH-689

LEFT HAND
RIGHT HAND



5030 SERIES

The concealed 5030 Series PACER is a heavy duty closer designed to fit in a narrow 1 3/4" aluminum transom. The double lever arm provides superior door control and the choice of finishes and arm functions meet virtually all architectural requirements.

LC-5034LH-689
LC-5034RH-689

LEFT HAND
RIGHT HAND



LCN Benchmark III® Low-Energy Power Operators Comes with a PREMIUM CONTROLLER

The 9131/9142 BENCHMARK III® by LCN is an electrically powered low-energy operator. It provides easy access for people with disabilities, the elderly or the frail. Designed primarily for automatic opening applications that occasionally require manual opening. The BENCHMARK III® is a cost-effective solution for retrofitting an activated or manual door.

LC-9131-FC36-PC-US28-PULL FULL COVER - 36 INCH
LC-9142-FC36-PC-US28-PUSH FULL COVER - 36 INCH



- Push 'N Go permits non-switch activation
- Adjustable opening and closing speed, all within ANSI guidelines and ADA codes
- Premium Microprocessor control box ensures reliability
- Tested internally to over three million cycles
- Quick and Easy to install!

PARTS

LC-925	PNEUMATIC TUBING (PER FOOT)
LC-OP160	OFFSET PIVOTS (LEFT HAND)
LC-SED210	TRANSFORMER FOR 4040SE
LC-1460-18-689	DROP PLATE FOR 1461 DOOR CLOSER
LC-1460-18PA-689	ADAPTER PLATE
LC-2030-3034	TRACK ROLLER FOR 2030 CLOSER
LC-2030-3038-689	TRACK ONLY FOR 2030 CLOSER
LC-2030-SPL-3034	P-1152 ROLLER
LC-4010-3049-LH-H90	HOLD OPEN ARM ONLY (LEFT HAND)
LC-4010-3049-RH-H90	HOLD OPEN ARM ONLY (RIGHT HAND)
LC-4020-18-689	ADAPTER PLATE (WHEN HEADER IS 2 INCH HIGH)
LC-4020-18G-689	ADAPTER PLATE (FOR FLUSH CEILING CONDITION)
LC-4030-3049-LH-H90	HOLD OPEN ARM ONLY (LEFT HAND)
LC-4030-3049-RH-H90	HOLD OPEN ARM ONLY (RIGHT HAND)
LC-4040-16-689	CORNER BRACKET FOR 4041 DOOR CLOSER
LC-4040-17-689	CORNER BRACKET FOR 4041 CLOSER
LC-4040-18-689	ADAPTOR PLATE (NARROW HEADER 2 INCH INSTALL)
LC-4040-18G-689	ADAPTOR PLATE (FOR FLUSH CEILING CONDITION)
LC-4040-18PA-689	ADAPTOR PLATE(FOR PARALLEL ARM LESS THAN 5-1/2
LC-4040-18TJ-689	ADAPTOR PLATE (CENTRES CLOSER ON TOP JAMB)
LC-4040-3049-HO-ARM-689	HOLD-OPEN COMPLETE ARM ONLY FOR 4041 CLOSER
LC-4040-3049CNS-689	HOLD OPEN CUSH ARM FOR 4041 CLOSER
LC-4040-3077-689	REG ARM ONLY FOR 4041 DOOR CLOSER
LC-4040-3077EDA-689	EDA ARM FOR 4041 CLOSER
LC-4040-61-689	SPACER FOR 4041 DOOR CLOSER
LC-4040-62PA	PARALLEL ARM SHOE
LC-4040-79-689	ROD & SHOE (ALUMINUM)
LC-4040-79-ELR-689	ROD AND SHOE (EXTRA LONG)
LC-4040-79LR-689	LONG ROD & SHOE
LC-4040SE-168	SLIDER FOR 4041 DOOR CLOSER
LC-4040SE-3034-ROLLER	TRACK ROLLER FOR 4040SE TRACK CLOSER
LC-4040SE-3038-120V-689	TRACK ONLY FOR 4040SE (120V)
LC-4040SE-3038-24V-689	TRACK ONLY FOR 4040SE (24V)
LC-4040SE-3077T-689	STANDARD ARM FOR 4040SE DOOR CLOSER
LC-4040SE-3210	SE TRANSFORMER FOR 4040SE DOOR CLOSER
LC-4040SE-73	END CAP FOR 4040SE DOOR CLOSER
LC-4040T-3038-689	STANDARD TRACK FOR 4040 DOOR CLOSER
LC-4110-18-689	ADAPTER PLATE FOR 4010/4110 SERIES CLOSERS
LC-7910-918	JAMB SWITCH (ACTUATOR)
LC-7910-956	ACTUATOR (4-1/2 DIAMETER WITH HANDICAP LOGO)

WINTERIZE

YOUR LOCKS NOW!

Keeps locks from freezing!

Frees frozen locks!

**Extreme Performance Lubricants
Environmentally Friendly & Non-Toxic**



- Repels water and moisture
- Won't freeze
- Totally lubricates and protects
- Provides excellent corrosion protection
- Significantly outlasts other lubricants
- Non-toxic, non-hazardous
- Provides total protection all year long

HA-LOCKSAVER-12.65-OZ

HA-LOCKSAVER-6.1-OZ

Cold Weather Tough at -65°F

LABEL-IT TAGS

One Hole

Label-It™ Plastic Tags

No. 250 (patent protected)

- More durable than paper, our tag is water-resistant.
- Tag has a 1-1/8" recess for our custom die-cut labels or permanent marker write-on space.
- Clamshell includes blank and pre-formatted paper labels. Templates are downloadable from www.luckyline.com/labels. Instructions included.
- Each tag has a 3/4" dia. key ring.

LU-25029 LABEL IT KEY TAGS ASST. COLOURS(25/PACK)

LU-25129 LABEL-IT KEY TAGS (WHITE/25 PER BOX)



KEY ORGANIZERS

Key Organizer

Nos. 610, 612

- Rugged polypropylene key cabinet organizes keys for home, business or garage.
- Has 24 numbered hooks to coordinate with identification label inside.
- Friction latch keeps cabinet closed tightly.
- No. 61200 supplied with two keys; uses Elgin 21 key blank and has 24 numbered hooks to coordinate with identification label inside.
- Supplied in beige with mounting screws and instructions.
- Melting point 1200 degrees F.

LU-61000 KEY ORGANIZER 1/PKG

LU-61200 LOCKING KEY ORGANIZER 1/PKG



KEY RACKS

6-Key Tag Rack

No. 60560 (patent protected)

- Scalloped design adds style to a popular item.
- Organize keys for home, office, cars, school, family.
- Store keys in one convenient location.
- Easy to install - includes adhesive tape for mounting.
- No. 60560 supplied in white with six assorted color No. 605 tags (see page 9).
- No. 60562 is supplied in charcoal gray with six clear No. 605 tags.

LU-60562 6 KEYTAG RACK WITH 7/8" RING 1 RACK/CARD





4-Key Tag Rack

No. 60540

- Rugged plastic rack keeps key tags organized.
- Supplied with four tags and adhesive strips to mount anywhere.

LU-60540 4-KEY TAG RACK 1 RACK/CARD



8-Key Tag Rack

No. 60580

- Rugged plastic rack keeps key tags organized.
- Mount with adhesive strips or screws (included).

LU-60580 8-KEY TAG RACK 1 RACK/CARD

KEY TAGS

Paper Tags

No. 270, 280

- Sturdy metal-rimmed white paper tags.
- No. 270 series has string attached.
- No. 280 series has overlapping ring attached.
- No. 290 series has metal clip attached.
- Ideal as price tags or product identification tags.



LU-27200 1-1/4" PAPER TAG WITH STRING (100/BOX)

LU-27229 1 1/4" PAPER TAG WITH STRING (25/BOX)

LU-28229 1-1/4" PAPER TAG WITH RING (25/BOX)

Solid Brass Tags

No. 260

- Solid brass tags for heavy-duty applications.
- Can be stamped or engraved by you.
- Perfect for pet tags, long term site I.D., or industrial use.
- .040" thick.



LU-26512 1 1/4" BRASS TAG. 1 HOLE, 5/CD

Aluminum Tags

No. 256

- 1-hole, color-coded tags for many uses, indoors & out.
- Can be stamped or engraved.
- Perfect for pet tags, facilities management, I.D. near water outlets.



LU-25605 1 1/4" ALUMINUM TAG 1-HOLE ASSORTED COLOURS



Key Tag w/Tang Ring

No. 123

- Durable, transparent tag for keys or luggage.
- Paper insert slides out easily.
- Nickel-plated tempered steel tang ring allows key removal without damage to fingernails.

LU-12302 KEY TAG W/ TANG RING, ASST, 2/CD



KeyTag w/Ball Chain

No. 101

- Durable, transparent tag for keys or luggage.
- Paper insert slides out easily.
- Heavy-duty 4-1/2" nickel-plated steel ball chain.

LU-10102 ID TAG W/BALL CHAIN, ASSORTED,2/CD



Key Tag w/Split Ring

No. 605

- Open/close flap over paper insert for identification with keys attached.
- Durable tag for keys. Also fits key tag racks. Made of tough polypropylene.
- Paper insert comes out for easy writing.
- No. 605 has 7/8" tempered steel split key ring.

LU-60502 KEY TAG W/ SPLIT RING, ASST. 2/CD



Key Tag w/Split Ring

No. 204

- Preferred tag of car rental companies.
- Tough plastic resists breakage.
- Durable tag for keys. Also fits key tag racks (see p. 7).
- Paper insert slides out for easy writing.
- 7/8" nickel-plated tempered steel split key ring.

LU-20402 KEY TAG W/ SPLIT RING CLEAR TAGS ONLY



Key Tag with Swivel Ring

No. 168

- Flexible tag with metal swivel.
- Paper insert slides out easily. Clear plastic insert protects writing from the elements.

LU-16802 KEY TAG W/ OVERLAPPING RING,ASST.2/CARD

IDENTIFIERS



Restroom Tag with Ring

No. 530, 531, 532

- Heavy-duty styrene key tags are rugged enough for constant use.
- Perfect for offices, gas stations, and other public buildings.
- These royal blue tags have a white imprint of Men and Women symbols. Combo has both.
- Rectangular with rounded corners and a 1" nickel-plated tempered split key ring.

LU-53000	BLUE BATHROOM TAG WITH KEY RING (WOMEN)
LU-53100	BLUE BATHROOM TAG WITH KEY RING (MEN)
LU-53200	BLUE BATHROOM TAG WITH KEY RING (MEN / WOMEN)



Luggage Tag

No. 631

- Simulated leather tag for identification of luggage.
- Plastic cover protects paper insert.
- Simple attachment with metal buckle.

LU-63101	SIMULATED LEATHER LUGGAGE TAG (1/CD)
----------	--------------------------------------



House Key Cap

No. 162 (patent protected)

- Makes a house key easy to find and easy to grip.
- Unique design inside cap accommodates Schlage, Kwikset and Weiser key heads.
- Vinyl resists tearing and color fading.
- Superior material is pliable, but won't break.

LU-16202	HOUSE KEY CAP, ASST 2/CD
LU-16206	HOUSE KEY CAP, ASST. NEON, 2/CD (5/PKG)
LU-16207	NEON HOUSE KEY CAPS ASST COLOURS (100/ DISPLAY BOX)
LU-16225	HOUSE KEY CAPS (100 PCS PER JAR)



Key Identifiers

No. 164, 166, 167

- Available in small, medium and large sizes.
- Keeps similar keys separated by color.
- Will stretch to fit over most standard key heads for easy key identification.
- Rubber-like vinyl resists cracking and color fading. Superior material; pliable, but won't break.
- Not recommended for ignition keys.

LU-16603	LARGE KEY IDENTIFIERS, ASST. 3/CARD
LU-16625	LARGE KEY IDENTIFIERS (150/JAR)
LU-16700	MEDIUM KEY IDENTIFIER ASST COLOURS (200/BOX)
LU-16704	MEDIUM ASSORTED COLOURS KEY IDENTIFIERS, 4/CD
LU-16707	MEDIUM ASSORTED NEON COLOURS (200/BOX)

IDENTIFIERS

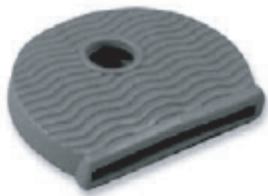

Key Caps

No. 165

- Keeps similar keys separated by color.
- Provides a firm grip on key head.
- Will stretch to fit over most standard key heads for easy key ID.
- Rubber-like vinyl resists tearing and color fading.
- Superior material; pliable, but won't break.

LU-16500 KEY CAPS ASSORTED COLOURS (200/BOX)

LU-16504 ASSORTMENT KEY CAPS (4/CD)

LU-16507 NEON KEY CAPS ASSORTED COLOURS (200/BOX)



Key Light with Replaceable Battery

No. 908

- Slim-profile, easy to use.
- Replacement battery allows for continued use.
- Key fits into plastic body of key light to easily find keyhole in the dark.

LU-90801 KEY LIGHT (1/CD)

LU-90808 KEY LIGHT REPLACEMENT BATTERY

KEY HIDERS & SAVERS



Large & Extra Large

Magnetic Key Hider

No. 910, 912

- Large key hider is made of rugged black plastic and holds two large keys.
- Extra large key hider is made of rugged black plastic and holds large, rubber-headed keys.
- Will not rust.
- 2 heavy-duty, superior magnets hold to any steel surface.
- Ideal for use on all vehicles, or any magnetic surface where you want to hide a key for emergencies

LU-91001 LARGE MAGNETIC PLASTIC KEY HIDER (1/CD)

LU-91201 EXTRA LARGE MAGNETIC PLASTIC KEY HOLDER (1/CD)



Key Savers

No. 917 (patent protected)

- Designed to carry a spare office, house and/or car key to prevent lock-outs.
- Clear sleeves.
- Same size as a credit card to fit in your wallet.
- No. 917 holds one large and one standard key.

LU-91701 KEY SAVER CARD, 1/CD



Pouch Key Hider

No. 913-914

- Tear-resistant nylon pouch attaches keys or cash to non-magnetic surfaces.
- Water-resistant adhesive anchors mounting pad to any clean surface.
- Effective hook and loop system secures pouch to pad, makes pouch removal easy.

LU-91301 EXTRA LARGE KEY POUCH 1/CD
LU-91401 LARGE COIN KEY POUCH (1/CD)



Wallet Key Hider

No. 909

- Durable plastic, sized to fit in a wallet.
- Holds two standard keys or one large-headed key.
- Keeps spare keys readily accessible.

LU-90901 WALLET CARD KEY HIDER, BLACK 1/CD



Rock Key Hider

No. 906

- Use in gardens next to house or garage.
- Slot in bottom of rock holds spare keys. Large enough to accommodate larger keys.
- Plastic cover holds key securely.
- Sturdy molded plastic resists damage in all-weather conditions.

LU-90601 KEY ROCK KEY HIDER

KEY RELEASES



Key Release

No. 427

- Keeps keys organized on separate rings. Can be removed individually.
- Slide keys to notched opening and press button to release.
- Made of tough plastic with five removable 1/2" tempered steel key rings.

LU-42701 KEY RELEASE KEY RING (1/CD)



Quick Release

No. 707

- Pull-apart key holder makes it easy to leave keys with valets, family, friends, etc.
- Made of tough nickel plated brass with two 7/8" nickel-plated tempered steel split key rings.

LU-70701 QUICK RELEASE KEY RING, NICKEL PLATED



3-WAY PULL APART

No. 715, 717

- 3-way pull apart key holder makes it easy to leave keys with valets, family, friends, etc.
- Additional ring helps to organize keys into three groups.
- Supplied with three 7/8" nickel-plated tempered steel split key rings.
- No. 715 supplied in bright nickel-plated brass.
- No. 717 supplied with a steel body and red and blue anodized aluminum ends.

- LU-71501 3-WAY PULL APART, NICKEL PLATED BRASS
- LU-71701 3-WAY PULL APART,ALUM (1/CD)
- LU-71712 3-WAY PULL-APART KEYRING (12/CARD)

LANYARDS



Lanyard

No. 414

- Fits around neck comfortably.
- Perfect to attach whistle or keeping house keys secure.
- Metal swivel allows clip to lie flat against chest.
- Made of strong woven nylon.

- LU-41401 LANYARD



Lanyard with Whistle

No. 422

- Fits around neck comfortably.
- Made of strong woven nylon.
- Popular with coaches.

- LU-42201 LANYARD WITH WHISTLE, ASST. 1/CD



Whistle

No. 421

- Lightweight, durable whistle.
- Made of tough molded plastic.
- Perfect for sports or personal security.
- Comes with 1" nickel-plated tempered steel split ring.

- LU-42101 WHISTLE WITH SPLIT RING, ASST. 1/CD

WRIST COILS



Wrist Coil

No. 410

- Superior quality coil always springs back and never loses its shape.
- Fits comfortably over wrist for work, exercise, water sports, etc.
- 7/8" nickel plated tempered steel split ring.

- LU-41001 WRIST COIL (1/CD)
- LU-41006 WRIST COIL, NEON 1/CD
- LU-41025 WRIST COIL ASSORTMENT (25/SMALL JAR)



Wrist Coil with Whistle

No. 423

- Superior quality coil always springs back, never loses its shape.
- Durable plastic whistle is securely attached with 7/8" nickel plated tempered steel split ring.
- Fits comfortably over wrist for work, exercise, sports.
- Whistle is perfect for additional personal security.

- LU-42301 WRIST COIL WITH WHISTLE, 1/CD

KEY HOLDERS



Squeeze Coin Holder

No. 941

- Coin holder doubles as a key chain.
- Flexible plastic opens with a simple squeeze to accept coins, closes tight when released.
- Supplied with 4-1/2" nickel plated steel ball chain.

- LU-94101 PLASTIC SQUEEZE COIN HOLDER WITH BALLCHAIN



Key Buoy

No. 921

- Durable key holder floats up to 5 keys easily.
- Red and white sections make it highly visible, easy to find on water or snow.
- Bottom half separates to provide a watertight storage compartment for identification, fishing license or cash.
- Made of tough plastic with a 6" nickel-plated brass ball chain that won't rust.

- LU-92101 KEY BUOY (1/CD)
- LU-92112 KEY BUOY (12/CARD)



Soft Key Float

No. 924, 928

- Soft foam key holder floats up to 5 keys easily.
- Neon colors make it highly visible and easy to find on water or snow.
- Made of vinyl-coated foam with a 6" nickelplated brass ball chain that won't rust.

- LU-92401 ORANGE KEY FLOAT, 1/CD
- LU-92412 ORANGE KEY FLOAT, 12/CARD
- LU-92801 YELLOW KEY FLOAT, 1/CD

KEYS, GRAPHITE

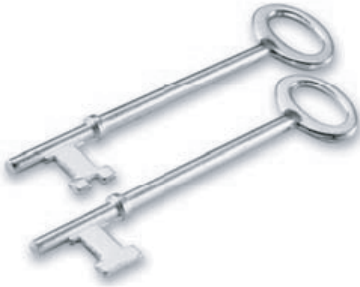

Skeleton Keys

No. 872

- For use on French doors and other antique door hardware.
- Brass plated zinc will not rust or bend under continuous use.
- Large head makes turning easy.
- Generic cuts are designed to fit most antique door locks

- LU-87202 FLAT AND NOTCHED TIP SKELETON KEY BRASS



Graphite Lubricant

No. 950

- A high-quality dry lubricant.
- Needle-nosed tube makes small applications easy.
- Use on wood, metal, plastic or rubber, wherever two surfaces rub together.
- Keep locks working smoothly when used sparingly.

- LU-95001 GRAPHITE TUBE, SIZE: 3.25 GRAM TUBE

KEY REELS



Key Bak®

No. 433-436

- High-quality key reel with 24" retractable pull of flat, linked steel chain.
- "The Original" Key Bak®, since 1949.
- Clip on belt or slip through belt for added security.
- Extremely durable. Ideal for security personnel, custodial staff and those who use keys frequently.
- Available in textured chrome finish or black finish.
- Includes a Lifetime Service Policy.

- LU-43601 KEY BAK, CLIP ON TEXTURED BLACK 1/CD



Spinner Key Bak®

No. 4355

- Heavy-duty key reel with unique full 360° rotation, reduces wear on chain.
- Use on left or right side with ease.
- 24" flat, linked steel chain.
- Snaps in and out of carrier for special uses. Clip-on with side-to-side locking to keep it on the belt.
- Includes a Lifetime Service Policy.

LU-43551 SPINNER KEY BAK



Super 48 Key Bak®

No. 4365

- Very high-quality key reel with 48" retractable pull.
- Kevlar® cord provides strength and a smooth draw.
- Unique ball-and-socket locking mechanism holds multiple keys. Carry more keys, small tools or phone.
- Heavy-duty polycarbonate case will not rust.
- Includes a Lifetime Service Policy.

LU-43651 SUPER 48 KEY BAK, CLIP ON BLACK 1/CD



Mini Bak®

No. 428-429, 438

- Small, lightweight retractable key reel in two styles: with a badge holder or split ring attached.
- Badge holder model is available in two versions: as a clip on for belt, pocket or purse; or pin on for cloth.
- Durable, high-impact plastic case and 3-strand nylon cord with a badge-holder or a split ring.

LU-95001 GRAPHITE TUBE, SIZE: 3.25 GRAM TUBE

METAL KEY CARRIERS



Secure-A-Key® Clip On

No. 404

- "The Original." We take special pride in the construction of this key carrier.
- Spring stainless steel won't rust, adds strength so product stays securely clipped to a belt.
- Patented double-locking arm prevents accidental key loss.
- Quickly clips onto belt, holds up under heavy use.
- Supplied with 1-1/8" nickel plated tempered steel split ring.

LU-40401 SECURE-A-KEY, CLIP ON (1/CD)

LU-40425 SECURE-A-KEY, CLIP ON (30/JAR)

**Secure-A-Key® Slip On**

No. 405

- "The Original." We take special pride in the construction of this key carrier.
- Stainless steel won't rust.
- Patented double-locking arm prevents accidental key loss.
- Preferred by law enforcement, slides through belt and holds up under heavy use.
- Supplied with 1-1/8" nickel-plated tempered steel split ring.

LU-40501 SECURE-A-KEY, SLIP ON (1/CD)
LU-40525 SECURE-A-KEY, SLIP ON (30/JAR)

**Belt Hook**

No. 406

- Slips easily over belt, holds firmly.
- Made of nickel-plated steel.
- 1-1/8" nickel plated tempered steel split ring snaps in and out with ease.

LU-40601 BELT HOOK KEY RING, SLIP ON (1/CD)

BOLT / TRIGGER SNAPS**Bolt Snaps**

No. 445, 451

- Strong nickel plated zinc and solid brass bolt snaps.
- Snaps easily to belt loop, book bag or purse strap.
- Bottom loop rotates so keys lie flat.

LU-44501 SMALL 7/8" RING BOLT SNAP, NICKEL PLATED ZINC (1/CD)
LU-45101 LARGE 1-1/8" BOLT SNAP, NICKEL PLATED ZINC (1/CD)

**Double-Ended Bolt Snap**

No. 449

- Medium-sized bolt snap with clips at each end.
- Makes for easy removal of keys when needed.
- Made of nickel-plated zinc, comes with 1-1/8" nickel-plated tempered steel split ring.

LU-44901 DOUBLE BOLT SNAP WITH SPLIT RING (1/CD)

**Heavy-Duty Bolt Snap**

No. 448

- Large solid brass bolt snap.
- Bottom loop rotates so keys lie flat.
- Supplied with 1" solid brass split ring.

LU-44801 HEAVY DUTY SOLID BRASS BOAT SNAP WITH RING

**Boat Snap**

No. 447

- Large, heavy-duty boat snap attaches easily to belt loop or purse strap.
- Bottom loop rotates so keys lie flat.
- Spring-loaded gate opens with light pressure.
- Made of nickel plated zinc, comes with 1-1/2" nickel-plated tempered steel split ring.

LU-44701 HEAVY DUTY BOAT SNAP WITH SPLIT RING 1/CD

**Trigger Snap**

No. 440-441

- Strong trigger snap opens wide to attach securely to belt loop, purse or other straps.
- Bottom loop rotates so keys lie flat.
- 1-1/8" nickel-plated tempered steel split ring.

LU-44001 TRIGGER SNAP, SOLID BRASS 1/CD

LU-44101 TRIGGER SNAP, NICKEL (1/CD)

**Small Trigger Snap**

No. 443

- Smaller nickel-plated zinc trigger snap keeps key accessible.
- Clips to belt loop or purse hardware.
- 7/8" nickel-plated tempered steel split ring.

LU-44301 MINI-TRIGGER SNAP WITH SPLIT RING 1/CD

KEY CLIPS**Quik Clip™**

No. 458

- Flexible plastic always retains its shape.
- Ergonomic design comfortably fits in hand.
- Inside hook keeps key ring secure.
- Clips to belt loop or purse.

LU-45801 QUICK CLIP (1/CD)

LU-45813 QUICK CLIP ASSORTMENT (125/BOX)

LU-45833 QUICK CLIP ASSORTMENT (40/BOX)

**C-Clip**

No. 460, 461

- Spring-loaded gate makes it easy to open and close with one hand.
- Clips to belt or purse.
- Made of anodized aluminum.
- No. 460 has a 7/8" nickel-plated tempered split key ring.
- No. 461 has a 1-1/8" ring.

LU-46001 SMALL C-CLIP, ANODIZED ALUMINUM (1/CD)

LU-46025 SMALL -C- KEY CLIP ASSORTMENT (50/JAR)

LU-46101 LARGE C-CLIP, ANODIZED ALUMINUM, (1/CD)

Not made for climbing.

LEATHER & NYLON



Leather Belt Hook with Snap

No. 453

- Durable leather belt hook features a clip for key removal and 1-1/8" nickel plated tempered steel split ring.
- Snap allows for easy removal from belt or purse.

LU-45301 LEATHER BELT HOOK WITH SNAP (1/CD) BLACK&BROWN



Nylon Key Clip

No. 411

- Unique snap-together key guard allows easy removal of keys.
- Tough plastic "J" clip attaches securely to belt hook, purse strap or book bag.
- Durable, woven nylon webbing meets military specifications.

LU-41101 4-3/4 NYLON KEY CLIP WITH J CLIP (BLACK)

COILS & POCKET CHAINS



Mini Designer Coil

No. 413

- Superior quality coil always springs back, never loses its shape.
- Small nickel plated trigger snap keeps keys on belt loop, book bag or purse strap.
- Clip trigger snap to key ring to create a convenient wrist coil for carrying keys.

LU-41301 MINI DESIGNER COIL (1/CD)



Designer Key Coil

No. 416

- Excellent for use with magnetic cards in restaurants or casinos, or for supervisors with multiple keys.
- Bulk packs of 100 available in all colors.
- Also available with a badge holder (Item No. 417) in Bulk Packs of 10/pkg. Please specify color.

LU-41601 DESIGNER KEY COIL (1/CD)

LU-41627 DESIGNER KEY COIL ASSORTMENT (25/MED JAR)



18" Pocket Chain with Trigger Snap

No. 401

- Trigger snap secures chain to belt loop or purse strap.
- Tough nickel finish steel link chain.
- 1-1/8" nickel-plated tempered steel split key ring holds keys or can attach to a wallet for security.

LU-40001 18' PAGER CHAIN, NICKEL PLATED STEEL

LU-40101 18' POCKET CHAIN W/ SMALL TRIGGER 1/CD

METAL KEY RING



Anodized Oval Key Ring

No. 737

- Sleek, colored aluminum key ring keeps keys easily in pocket or purse.
- Brass screw closure makes taking keys on and off simple and fast.

LU-73701 ANODIZED OVAL KEY RING (1/CD)



Turn Sleeve & Spring Sleeve

No. 702, 704

- Compact key ring with screw or springloaded closures.
- No. 702: Unscrew to open, screw to close.
- No. 704: Pull to open, release to close.

LU-70201 TURN SLEEVE, NICKEL PLATED STEEL (1/CD)

LU-70401 SPRING SLEEVE, NICKEL PLATED STEEL (2/CD)



Flex-o-Loc™

No. 711, 731

- Strong, flexible, corrosion-resistant aircraft cable key ring.
- Unique patented ball-knob and socket closure locks and unlocks easily.
- Use as key ring or binder ring to hold products or documents together.
- Available in these finishes: brass-plated stainless steel, stainless steel, slim stainless steel, nylon coated cable and monofilament.

LU-71101 FLEX-O-LOC NYLON COATED CABLE KEY RING



Twisty® Key Ring

No. 811, 829, 841

- Can be crimped for permanent closure.
- Strong, flexible, corrosion-resistant aircraft cable key ring.
- Unique patented locking mechanism assures keys stay put.
- Use as key ring or binder ring to hold products or documents together.
- Available in these finishes: brass-plated stainless steel, stainless steel, slim stainless steel, nylon-coated cable and monofilament.

LU-81101 TWISTY NYLON COATED CABLE KEY RING 1/CD

BINDER RINGS

Binder Ring

No. 243, 246

- Holds multiple documents together.
- Made of nickel-plated steel.
- Available in 1" and 2"



LU-24300 1" CLIP TOGETHER BINDER RING (50/BOX)

LU-24302 1" BINDER RING NICKEL PLATED STEEL (2/CD)

LU-24600 2" CLIP TOGETHER BINDER RING (25/BOX)

LU-24602 2" BINDER STEEL NICKEL STEEL (2/CD)

SPLIT KEY RINGS



Color Split Key Rings

No. 794

- Resilient tempered steel won't lose shape even after repeated use.
- Powder coating provides a durable finish.

LU-79401 1" SPLIT RING (1/CD)



Nickel-Plated, Tempered Steel Ring

No. 760-770, 791

- Key rings hold multiple keys securely.
- Resilient tempered steel won't lose shape even after repeated use.
- Made of nickel-plated tempered steel.

LU-76402 1" SPLIT RING, NICKEL PLATED STEEL (2/CD)

LU-76602 1 1/4" SPLIT RING/ NICKEL PLATED STEEL (2/CD)

LU-79100 3" SPLIT KEY RING (BOX/25)











Brass-Plated, Tempered Steel Ring

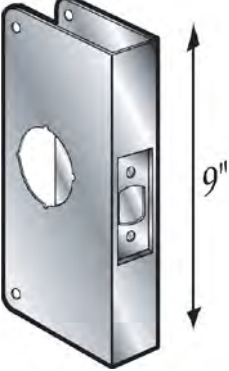





No. 774-776

- Durable key rings hold multiple keys securely.
- Resilient tempered steel won't lose shape even after repeated use.
- Alternative ring for use with decorative key holders.
- Made of brass-plated tempered steel.

LU-77402 1" SLIM SPLIT RING/ BRASS PLATED STEEL

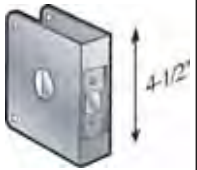
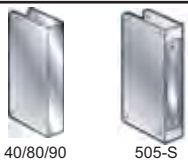
LU-77602 1 1/4" SLIM SPLIT RING, BRASS PLATED

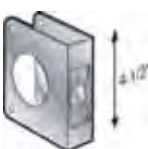
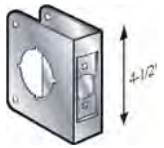
	DESCRIPTION	PART NUMBER	STANDARD SERIES	BACK SET	DOOR THICKNESS	OVERALL SIZE
	DOOR LOCKS WITH 2 1/8" BORE	MG-1-BN MG-1-PB MG-1-S	US10 US3 US32D	2 3/8"	1 3/8"	4" X 9"
		MG-2-BN MG-2-PB MG-2-S	US10 US3 US32D	2 3/8"	1 3/4"	4" X 9"
		MG-3S MG-3-PB	US3 US32D	2 3/4"	1 3/8"	4 1/4" X 9"
		MG-4-AB MG-4-BN MG-4-PB MG-4-S	US5 US10 US3 US32D	2 3/4"	1 3/4"	4 1/4" X 9"
		MG-4S-12	US32D	2 3/4"	1 3/4"	5" X 12"
		MG-4S-2	US32D	2 3/4"	1 3/4"	4-3/4" x 9"
	FOR ADA LEVER LOCKS WITH 2 1/8" BORE (BEST, SARGENT, AND CORBIN)	MG-4-S9KN	US32D	2 3/4"	1 3/4"	4 1/4" X 9"
	1 1/2" TOP 2 1/8" BOTTOM BORE 6" BETWEEN CENTERS	MG-464-PB MG-464-S	US3 US32D	2 3/4"	1 3/4"	4 1/4" X 12"
	2 1/2" TOP 2 1/8" BOTTOM BORE 6" BETWEEN CENTERS	MG-461-PB MG-461-S	US3 US32D	2 3/4"	1 3/4"	4 1/4" X 12"
	2 1/2" TOP 2 1/8" BOTTOM BORE 3 5/8" BETWEEN CENTERS	MG-481-BN MG-481-PB MG-481-S	US10 US3 US32D	2 3/4"	1 3/4"	4 1/4" X 9"
	SIMPLEX 1000 SERIES & ALARM LOCK DL-2500 9" UNIT KEY-IN-KNOB CONVERSION 14" FOR MORTISE CONVERSION	MG-1000-9AB MG-1000-9S	US5 US32D	2 3/4"	1 3/4"	5" X 9"
		MG-1000-14AB MG-1000-14PB MG-1000-14S	US5 US3 US32D	2 3/4"	1 3/4"	5" X 14"
	COVERS SIMPLEX PREP. 2 1/8" BORE 4 1/4" FROM BOTTOM EPLEX 2000	MG-1004-14PB MG-1004-14S	US3 US32D	2 3/4"	1 3/4"	5" X 14"
		MG-1005-14S	US32D			
	FOR UNICAN 4000 SERIES INSTALLATION	MG-4000-14S	US32D	2 3/4"	1 3/4"	5" X 14"

	DESCRIPTION	PART NUMBER	STANDARD SERIES	BACK SET	DOOR THICKNESS	OVERALL SIZE
	FOR MORTISE LOCKS 1 1/4" X 8" FACEPLATE WITH THRU BOLTS U.S.PAT. 4139999	MG-504-S	US32D	2 3/4"	1 3/4"	5" X 12"
	FOR DOOR LOCKS WITH 2 1/8" BORE LARGE BACKSETS AND THICK DOORS	MG-55-PB MG-55-S	US3 US32D	5"	1 3/4"	6 1/2" X 14"
	FOR INSTALLING DEADBOLTS WITH 1 1/2" BORE	MG-5-BN MG-5-PB MG-5-S	US10 US3 US32D	2 3/8"	1 3/8"	4" X 4 1/2"
		MG-6-PB MG-6-S	US3 US32D	2 3/8"	1 3/4"	4" X 4 1/2"
		MG-7-PB MG-7-S	US3 US32D	2 3/4"	1 3/8"	4 1/4" X 4 1/2"
		MG-8-BN MG-8-PB MG-8-S MG-8-AB	US10 US3 US32D US5	2 3/4"	1 3/4"	4 1/4" X 4 1/2"
	BLANK CHANNELS WITH MOUNTING HOLES	MG-40-PB MG-40-S	US3 US32D	N/A	1 3/4"	4 1/4" X 9"
		MG-80-S MG-90-S	US3 US32D	N/A	1 3/4"	4 1/4" X 4 1/2" 5" X 12"
		MG-505-S	US32D	N/A	1 3/4"	5" X 12"
	FOR LOCK AND DEADBOLT 1 1/2" TOP AND 2 1/8" BOTTOM BORE 4" BETWEEN CENTERS	MG-264-BN MG-264-PB MG-264-S	US10 US3 US32D	2 3/8"	1 3/4"	4" X 9"
		MG-484-BN MG-484-PB MG-484-S	US10 US3 US32D	2 3/4"	1 3/4"	4 1/2" X 9"
	FOR INSTALLING DEADBOLTS WITH 2 1/8" BORE	MG-61-BN MG-61-PB MG-61-S	US10 US3 US32D	2 3/8"	1 3/4"	4" X 4 1/2"
		MG-71-PB MG-71-S	US3 US32D	2 3/4"	1 3/8"	4 1/4" X 4 1/2"
		MG-81-BN MG-81-PB MG-81-S	US10 US3 US32D	2 3/4"	1 3/4"	4 1/4" X 4 1/2"
	FOR ADA LEVER LOCKS BEST, MARKS, SARGENT, AND CORBIN	MG-81-S9KN	US32D	2 3/4"	1 3/4"	4 3/4" X 4 1/2"
	FOR SCHLAGE RHODES, ARROW SIERRA, CORBIN 800, SARGENT 10, YALE 5400LN	MG-81-S-2	US32D	2 3/4"	1 3/4"	4 3/4" X 4 1/2"

	FOR SCHLAGE COBRA SERIES	MG-5196-14S-32D	US32D	2 3/4"	1 3/4"	5" X 14"
---	---------------------------------	------------------------	--------------	---------------	---------------	-----------------

SECURITY STRIKES



1-1/4"x4-7/8"
FOR DEADBOLTS
 Heavy gauge steel
 For all wood frames
MG-755B



1-5/8"x7-3/4"
FOR DEADBOLTS
 Heavy gauge steel
 For 1-3/4" door frames
MG-765B
MG-765C

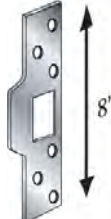

1-1/4"x8"
FOR LOCKSETS
 Heavy gauge steel*For
 all wood frames
MG-770B

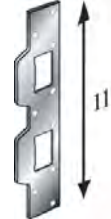

1-5/8"x7-3/4"
FOR DEADBOLTS
 Heavy gauge steel
 For 1-3/4" door frames For
 3-5/8" or 4" between centers
MG-775C

LATCH GUARDS



6" LATCH GUARD
 Heavy gauge steel
 Fits all backsets,
 deadbolts and
 key-in-knob locks
 Protects latch or bolt
MG-8845B

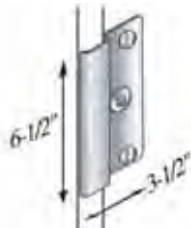

6-1/2" LATCH GUARD
 Heavy gauge steel
 1-1/8" backset
 Cylinder guard
MG-8852AL
MG-8852DU

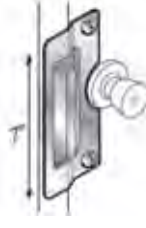

7" LATCH GUARD
 Heavy duty
 Fits all backsets,
 deadbolts and
 key-in-knob locks
 Protects latch or bolt
MG-8848C



11-3/4" UNIVERSAL LATCH GUARD
 Out-Opening
 Doors, with 1" x
 8-3/4" Cutout
MG-8849DU



11-3/4" LATCH GUARD
 Fits single
 & double locks
 up to 6"
 on center.
MG-8850C
MG-8850DU

IN-SWING LATCH GUARDS

Fits all backsets. Reinforces door and frame. Prevents spreading of frame. Hardened concealed screws

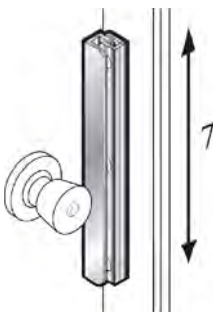

MG-8840B 7" LATCH GUARD
MG-8840C 7" LATCH GUARD
MG-8840DU 7" LATCH GUARD



MG-8843B 12" LATCH GUARD
MG-8843C 12" LATCH GUARD

STRIKE-3 HEAVY DUTY HIGH SECURITY BOX STRIKE

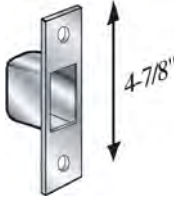

One piece. 16 gauge steel, 4-7/8" high x 1-1/4" wide strike with a deep drawn box. (1-5/8" high x 3/4" wide x 1-1/8" deep). Four 2" hardened screws secures strike & face plate. Two mounting holes offset in bottom of box secures strike to frame stud.

MG-747-B

UNI-FORCE DOOR EDGE GUARD

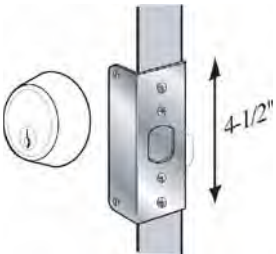

All units solid 22 ga. brass, bronze, on stainless steel, fits square or bevel edge doors. Edge prep has 1" centre hole and two #8 countersunk holes 1-5/8" on centre plus two #10 holes 3-1/2" apart with 2" screws.

Polished Brass	Antique Brass	Satin Bronze	Stainless Steel	Door Thickness
MG-20PB	MG-10AB	MG-10BN MG-20BN	MG-10S MG-20S	1-3/8" 1-3/4"

FILLER PLATES

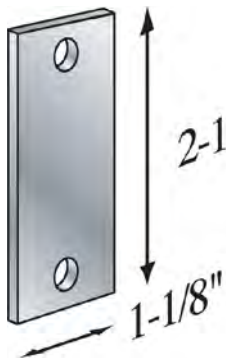

FILLER PLATE
1 1/8" X 2 1/4"
For 161 latch cut out

MG-8873PC

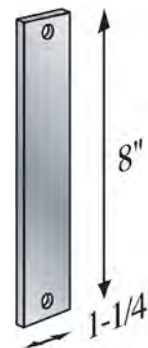

FILLER PLATE
1 1/4" X 8"
For 86 mortise lock
face cut out

MG-8875PC

SPECIALTY STRIKES

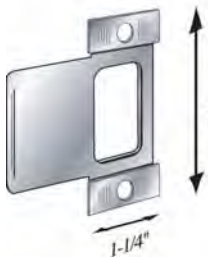

2-3/4" EXTENDED LIP STRIKE
Adjust-a-strike for wood
frames with 1/4" adjustment

MG-4530B

MISC. HARDWARE



MAR GUARD
Door edge protector
Fits 1-3/4"
thick doors

MG-8717-BRASS

HOLE COVER AND ADAPTERS

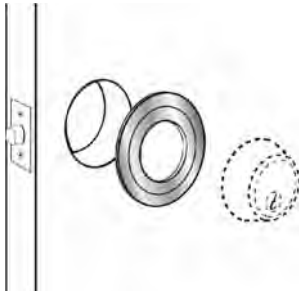

ADAPTER PLATE 2 3/4" DIA.
FOR SCHLAGE DEADBOLTS
WITH 1 1/2" BORE IN A 2 1/8"
BORE.
1 1/2" INSIDE DIAMETER

MG-8863B
MG-8863C

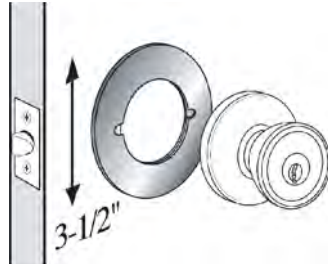

COVER PLATE 3 1/2" DIA.
FOR 2 1/8" BORE LOCKS
COVERS DAMAGED DOORS
CHANGE BACKSETS
TO AND FROM 2 3/4 & 2 3/8

MG-8865B
MG-8865C

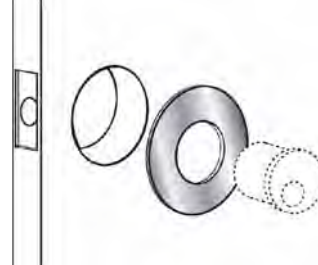

ADAPTER PLATE 2 5/8" DIA
FOR RIM OR MORTISE
CYLINDERS
COVERS UP TO
2 1/8" DIA. HOLE

MG-8860C

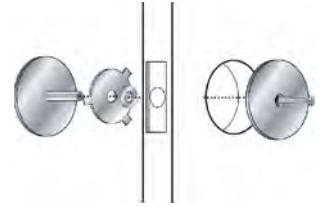

HOLE COVER
2 5/8" DIA.
COVERS 1/2"
TO 2 1/8" HOLES

MG-8868PC
MG-8868B
MG-8868C

PATIO DOOR AND WINDOW LOCKS



Sliding Door Bar Heavy Gauge Steel,
Maximum Security, Locks in Vented
or Closed Position. Adjusts to Fit 28"
to 48" Door, Mounts on Inside or
Outside Sliders. Lock Prevents
Lifting Bar from Outside, Easy
Installation, Safely Stores Down
When Not in Use.

MG-8820-W



Sliding door bar heavy
gauge steel, Maximum
security, Locks in vented
or closed position.
Adjusts to fit 28" to 48"
door, Mounts on inside
or outside sliders. Lock
prevents lifting bar from
outside, Easy
installation, Safely
stores down when not in
use.



MG-8825-W-KA-655 WHITE
MG-8825-DU-KA-655 BROWN



Heavy duty, tamper proof sliding
window lock. Child proof and in an
Aluminum finish.

MG-8740

KICK PLATES



MG-9008V-628-8X30 8" X 30", ALUMINUM
MG-9008V-630-8X30 8" X 30", STAINLESS STEEL
MG-9010V-628-8X34 8" X 34", ALUMINUM
MG-9010V-630-8X34 8" X 34", STAINLESS STEEL

MASTER #1 LAMINATED PADLOCKS

- 1-3/4" (44mm) wide laminated steel body for superior strength
- Hardened steel shackle for extra cut resistance
- 4-pin cylinder helps prevent picking
- Dual locking levers provide extra pry resistance
- Thousands of key changes maximize key integrity
- Proprietary rustproofing for longer life

MA-1UP

MA-1UPLJ

MA-1KA-2001

MA-1KA-2002

MA-1KA-2004

MA-1KA-2013

MA-1KA-2043

MA-1KA-2081

MA-1KA-2126

MA-1KA-2129

MA-1KA-2176

MA-1KA-2196

MA-1KA-2251

MA-1KA-2289



MA-1KA-2359

MA-1KA-2396

MA-1KA-2402

MA-1KA-2532

MA-1KA-2634

MA-1KA-2699

MASTER #5 LAMINATED PADLOCKS

- 2" (51mm) wide laminated steel body for superior strength
- 4-pin cylinder helps prevent picking
- Hardened boron alloy shackle for superior cut resistance
- Dual locking levers provide extra pry resistance
- Thousands of key changes maximize key integrity
- Proprietary rustproofing for longer life

MA-5UP

MA-5KA-A1463

MA-5KA-A272

MA-5KA-A283

MA-5KA-A479

MA-5KA-A505

MA-5KA-A851



MASTER #500 LAMINATED PADLOCKS

- 1-3/4" (44mm) wide laminated steel body for superior strength
- Steel shackle provides strong cut resistance
- Warded locking mechanism minimizes jamming from dirt and grime
- Rustproofed for extended wear

MA-500KA-255



MASTER #3 LAMINATED PADLOCKS

- 1-9/16" (40mm) wide laminated steel body for superior strength
- Hardened steel shackle for extra cut resistance
- 4-pin cylinder helps prevent picking
- Dual locking levers provide extra pry resistance
- Thousands of key changes maximize key integrity
- Proprietary rustproofing for longer life

MA-3

MA-3LF-RED

MA-3KALH-030

MA-3KA-0301

MA-3KA-0356

MA-3KA-0357

MA-3KA-0441

MA-3KA-0464

MA-3KA-0536

MA-3KA-0890

MA-3KA-0933

MA-3KA-3221

MA-3KA-3223

MA-3KA-3252

MA-3KA-3286

MA-3KA-3303

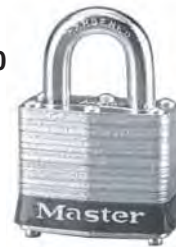

MA-3KA-3313

MA-3KA-3318

MA-3KA-3329

MA-3KA-3352

MA-3KA-3554

MA-3KA-3635

MA-3KA-3753

MA-3KA-3769

MA-3KA-3789

MA-3KA-3795

MA-3KA-3835

MA-3KA-3860

MA-3KA-3881

MA-3KA-3900

MA-3KA-3987

MASTER #7 LAMINATED PADLOCKS

- 1-1/8" (29mm) wide body
- Laminated steel body for superior strength
- Steel shackle provides strong cut resistance
- 4-pin cylinder helps prevent picking
- Hundreds of key changes maximize key integrity
- Proprietary rustproofing for longer life

MA-7



MASTER #21 REKEYABLE PADLOCKS

- 1-3/4" (44mm) wide laminated steel body for superior strength
- Hardened steel shackle for superior cut resistance
- 5-pin tumbler cylinder for added security
- Removable cylinder can be replaced or repinned
- More than 9,000 key changes available for maximum pick resistance

MA-21

MA-21LJ

MA-21W1

MA-21WO

1092NR KEYWAY

2-1/2 SHACKLE

W1 KEYWAY (1092)

LESS CYLINDER



No. 443 Padlocks



- 1-9/16" (40mm) wide laminated steel body for superior strength
- Removable hardened post for extra cut resistance
- 4-pin cylinder helps prevent picking
- Thousands of key changes for maximum pick resistance
- Multiple post lengths to fit specific applications
- Prevents access to vending and utility valve equipment

MA-443KA-3252 MASTER POST LOCK

NO. 60R Padlock Eyes



- Steel padlock eyes with large diameter shackle hole
- Mount virtually anywhere
- Ideal for gates and shed doors

MA-60R MASTER PADLOCK EYE FIXTURE (90 DEGREE)

No. 5401 Select Access™ Wall Mount Key Storage Security Lock



- Holds up to 5 keys for house or car in a convenient location for regular use
- Wall mount design for permanent installation
- Set-your-own 4-digit combination for keyless convenience
- Key Storage door pivots open smoothly and remains attached to lockbody for convenient operation
- Reinforced body withstands hammering and sawing
- Cover protects combination dials from weather, dirt and grime
- Outside Dimensions: 3-1/4"(83mm) wide x 4-3/4"(121mm) long x 1-1/2"(32mm) deep

MA-5401D MASTER WALL MOUNTED KEY STORAGE

MASTER 6000 SERIES PADLOCKS 2-1/8" WIDTH BODY

- 2-1/8" (54mm) wide laminated steel body for superior strength
 - Hardened boron alloy shackle for superior cut resistance
 - 5-spool pin tumbler cylinder for added pick resistance
 - Removable cylinder can be replaced or repinned
 - Dual ball bearing locking mechanism resists pulling and prying
 - Body and cylinder covers protect locks from water, dirt and grime
- Heavy steel bodies withstand forcible attacks

MA-6121

MA-6121KA-10G001

MA-6121KA-10G016

MA-6121KA-10G028

MA-6121KA-10G061

MA-6121KA-10G101

MA-6121KA-10G103

MA-6121KA-10G155

MA-6121KA-10G156

MA-6121KA-10G158

MA-6121KA-10G172

MA-6121LJ

MA-6121LJ-KA-10G001

MA-6121WO



MA-6121W1-KZ

MA-6121MK-SG410

MA-K6000CRM-SG410

MASTER 6000 SERIES PADLOCKS 2-3/8" WIDTH BODY

- 2-3/8" (61mm) wide laminated steel body for superior strength
- Hardened boron alloy shackle for superior cut resistance
- High security solid iron shackle shroud resists harsh physical attacks
- 5-spool pin tumbler cylinder for added pick resistance
- Removable cylinder can be replaced or repinned
- Dual ball bearing locking mechanism resists pulling and prying

MA-6125KA-10G002

MA-6125KA-10G016

MA-6125KA-10G028

MA-6125KA-10G061

MA-6125KA-10G101

MA-6125KA-10G103

MA-6125KA-10G155

MA-6125KA-10G156

MA-6125KA-10G158

MA-6125KA-10G172

MA-6125

MA-6125WO

MA-6125LJ

MA-6125LJ-KA-10G451



MASTER 6000 SERIES PADLOCKS 2-5/8" WIDTH BODY



MA-6127

MA-6127KA-10G003

MA-6127LJ

- 2-5/8" (67mm) wide laminated steel body for superior strength
- Hardened boron alloy shackle for superior cut resistance
- 5-spool pin tumbler cylinder for added pick resistance
- Removable cylinder can be replaced or repinned
- Dual ball bearing locking mechanism resists pulling and prying
- Body and cylinder covers protect locks from water, dirt and grime
- Heavy steel bodies withstand forcible attacks

MASTER 6000 SOLID STEEL PADLOCKS



MA-6230

MA-6230KA-10G004

- 2-1/2" (64mm) wide, hardened solid steel body
- Hardened boron alloy shackle for superior cut resistance
- 5 spool pin tumbler cylinder for added pick resistance
- Removable cylinder can be replaced or repinned
- High security padlock resists tough abuse

MASTER 6000 SERIES PADLOCKS WITH SHROUD

- Laminated steel body for superior strength
- Hardened boron alloy shackle for superior cut resistance
- Solid iron shackle shroud resists harsh physical attacks
- 5 spool pin tumbler cylinder for added pick resistance
- Removable cylinder can be replaced or repinned
- Dual ball bearing locking mechanism resists pulling and prying



MA-6321 HIGH SECURITY PADLOCK 2-1/8 BODY (KD)

MA-6325 HIGH SECURITY PADLOCK 2-3/8 BODY (KD)

MA-6327 HIGH SECURITY PADLOCK 2-5/8 BODY (KD)

MA-6327KA-14G509

MASTER 6000 PADLOCKS FOR I/C CORES



MA-6421WO

MA-6421LJWO 2-3/8" SHACKLE

- Body and cylinder covers protect from water, dirt and grime
- Hardened boron alloy shackle for superior cut resistance
- Heavy steel bodies withstand forcible attacks
- Chrome rustproofing provides longer life
- Fits all small format interchangeable core cylinders (Not Included)



6000 SERIES ACCEPTING K.I.K. CYLINDERS

- Use the same key that opens your security doors
- 2-1/8" (54mm) wide body and cylinder covers protect from water, dirt and grime
- Hardened boron alloy shackle for superior cut resistance
- A perfect connection to your door security system, including Schlage®, Kwikset®, Yale® and 23 more



6000 SERIES ACCEPTING K.I.K. CYLINDERS

- Use the same key that opens your security doors
- 2-5/8" (67mm) wide body and cylinder covers protect from water, dirt and grime
- Hardened boron alloy shackle for superior cut resistance
- A perfect connection to your door security system, including Schlage®, Kwikset®, Yale® and 23 more



MA-6621LJWO
MA-6621WO

K.I.K. CYLINDER 2-3/8 SHACKLE
K.I.K. CYLINDER 2-1/8 WEATHER

MA-6627LJWO
MA-6627WO

K.I.K. CYLINDER 2-3/8 SHACKLE
K.I.K. CYLINDER 2-1/8 WEATHER

THE 6000 SERIES DRIVERS LISTED BELOW WILL BE NEEDED WITH YOUR DESIRED CYLINDER TO OPERATE THE KEY-IN-KNOB PADLOCKS

MA-2980626
MA-2980627
MA-2980628

MASTER DRIVER FOR ILCO/LORI K.I.K. CYLINDER
MASTER DRIVER FOR MEDECO CYLINDER
MASTER DRIVER FOR SCHLAGE/PRIMUS/ILCO 15995 CYLINDER

6000 ALUMINUM SERIES PADLOCKS

- 1-9/16" wide black aluminum body, 1/4" shackle w/1-1/16" clearance
- Baked on powder-coated finish stays bright
- Ideal for corrosive and tough environments
- High visibility color plus high security
- Keyed different 5-pin tumbler cylinder
- 6-pin cylinder available



MA-6835LF-BLK BLACK MA-6835LF-ORJ ORANGE
MA-6835LF-BLU BLUE MA-6835LF-RED RED
MA-6835LF-GRN GREEN

ORIGINAL REPLACEMENT PINS

MA-1-0360 BOTTOM PIN BLACK
MA-1-0361 BOTTOM PIN VIOLET
MA-1-0362 BOTTOM PINS RED
MA-1-0363 BOTTOM PINS BLUE
MA-1-0364 BOTTOM PINS YELLOW
MA-1-0365 BOTTOM PINS GREEN
MA-1-0366 BOTTOM PINS BROWN
MA-1-0367 BOTTOM PINS BLACK
MA-1-0368 BOTTOM PINS
MA-1-0369 SPRINGS
MA-1-0391 TOP PINS #1
MA-1-0392 TOP PINS #2
MA-1-0393 TOP PINS #3
MA-1-0394 TOP PINS #4
MA-1-0395 TOP PINS #5
MA-1-0396 TOP PINS #6
MA-1-0397 TOP PINS #7



6000 SERIES REPLACEMENT CYLINDERS

MA-296W1KZ
MA-296W27KZ
MA-296W6000-10G016
MA-296W6000-10G028
MA-296W6000-10G061
MA-296W6000-10G101
MA-296W6000-10G103
MA-296W6000-10G155
MA-296W6000-10G156
MA-296W6000-10G158
MA-296W6000-10G172
MA-293S6127LH 1-7/8" SHACKLE FOR 6127 & 6627WO
MA-293S6230LH 2" SHACKLE FOR MA-6230





The Master Lock #291 Pin Kit provides the pins and tools necessary to remove and repin cylinders.

MA-291

CYLINDER RETAINERS #21 Lock (Order No. 21-0372) #27 Lock (Order No. 27-0371) PRO SERIES (Order No. 6121-0420) (ALL)	MASTER PIN No. 1 VIOLET Order No. 1-0391	MASTER PIN No. 2 RED Order No. 1-0392	MASTER PIN No. 3 BLUE Order No. 1-0393	MASTER PIN No. 4 YELLOW Order No. 1-0394	MASTER PIN No. 5 GREEN Order No. 1-0395	MASTER PIN No. 6 BROWN Order No. 1-0396	
	KEY CUT GAGE (Order No. 290-0371)	MASTER PIN No. 7 BLACK Order No. 1-0397	DRIVE PIN MASTER Order No. 7-0368	No. 0 PIN BLACK Order No. 1-0360	No. 1 PIN VIOLET Order No. 1-0361	No. 2 PIN RED Order No. 1-0362	No. 3 PIN BLUE Order No. 1-0363
	CYLINDER ASSEMBLY TOOL (Order No. 290-0372)	No. 4 PIN YELLOW Order No. 1-0364	No. 5 PIN GREEN Order No. 1-0365	No. 6 PIN BROWN Order No. 1-0366	No. 7 PIN BLACK Order No. 1-0367	DRIVER PIN SPOOL Order No. 6121-0419	
ALLEN WRENCHES 3/32" (Order No. 21-0374) 7/64" (Order No. 27-0374)	RETAINING NUT FOR 21 LOCK Order No. 21-0373	RETAINING NUT FOR 27 LOCK Order No. 27-0373	RETAINING NUT PRO SERIES (ALL) Order No. 6121-0421	EXTENSION FOR 4-PIN CYLINDERS Order No. 27-0334	TUMBLER SPRINGS Order No. 1-0369		

6000 SERIES PARTS



6000 SERIES REPLACEMENT SHACKLES

- MA-293S6121LJ** 2-3/8" SHACKLE ONLY FOR 6121, 6621WO & 6840
- MA-293S6121LN** 5-3/4" SHACKLE FOR 6621 6121 6840
- MA-293S6125LJ** 2-3/8" SHACKLE FOR 6125,6850,6851-6852

- MA-6121-0423** MASTER NON-KEY RETAINING EXTENSION
- MA-6121-0424** MASTER KEY RETAINING CYLINDER EXTENSION



No. 1525 Padlocks

Key Controlled locks which have a key override for supervisory access.

Double reinforced construction with stainless steel outer case and cold rolled steel inner case for strength and durability. Nickel plated hardened steel shackle resists rust. Easy, dependable 3-number dialing with automatic scrambling feature to prevent reopening of lock. Standard black dial.

- MA-1D**
- MA-1500D**
- MA-1500KA-903119**
- MA-1502**
- MA-1525K**
- MA-175-D**
- MA-175D-LH**
- MA-1525-V67**

- MASTER PADLOCK (D)**
- MASTER COMBINATION PADLOCK (CARDED)**
- MASTER COMBINATION PADLOCK (BOXED)**
- MASTER COMBINATION PADLOCK (SERIALIZED)(BOXED)**
- MASTER OVERRIDE KEY (V67) FOR 1525**
- MASTER RESETTABLE COMBINATION PADLOCK**
- MASTER RESETTABLE PADLOCK (2-1/4 LONG SHACKLE)**
- MASTER COMBINATION PADLOCK WITH KEY OVERRIDE (V67)**

No. 453L PLUG & HOIST CONTROL COVER



- Effectively locks out odd size and large electrical connectors and hoist controls
- Patent-pending lockout, the cinch sack offers broad application solutions sized at 7" diameter by 17" tall
- Insert PVC tubing to block access to hoist control buttons
- Flexible & durable rip-stop nylon bag fits easily in safety tool boxes
- Locks out up to 6 padlocks or hasps
- Trilingual lock out warning printed on bag

ML-453L MASTER LARGE ELECTRICAL CONNECTORS

No. 487 ROTATING ELECTRICAL PLUG LOCKOUT



- Outward/inward rotation allows for easier application & storage
- Surrounds the electrical plug and protects against accidental reconnection
- Patent-pending rotating design allows for easier installation in confined space applications
- Complete with high-visibility permanent safety labels (English, French & Spanish)
- Tough, lightweight, dielectric Xenoy thermoplastic bodies withstands chemicals
- Performs effectively in extreme conditions, temperature range -50F (-46C) to +350F (177C)
- For electrical plug sizes up to 2-1/4" diameter X 3-1/4" with cord diameter up to 3/4" (Most 110 and many 220-volt plugs)

ML-487 MASTER ELECTRICAL PLUG COVER SMALL 120, 240 VOLT

No. 488 ROTATING ELECTRICAL PLUG LOCKOUT

- Outward/inward rotation allows for easier application & storage
- Surrounds the electrical plug and protects against accidental reconnection
- Patent-pending rotating design allows for easier installation in confined space applications
- Each size rotates into itself for compact storage in safety tool boxes
- Complete with high-visibility permanent safety labels (English, French & Spanish)
- No. 488 labels can be written-on to identify the responsible person then erased for the next job
- Tough, lightweight, dielectric Xenoy thermoplastic bodies withstands chemicals
- Performs effectively in extreme conditions, temperature range -50F (-46C) to +350F (177C)
- For electrical plug sizes up to 3" diameter X 6" with cord diameter up to 3/4" (Most 220-550 volt plugs)



ML-488 MASTER ELECTRICAL PLUG COVER LARGE 220-550V PLUGS

No. 493B GRIP TIGHT CIRCUIT BREAKER LOCKOUT



- Grip Tight works with simple thumb turn and clamping handle
- Patent-pending innovative design effectively lockouts out circuit breakers, plugs and wall switches
- Grip Tight combines great strength with universal fit
- Exclusive design fits standard height and tie-bar toggles
- Narrow profile permits side-by-side breaker lockout
- Compact device is easy to carry and easy to store
- Device accepts all American Lock and Master Lock safety padlock shackles and lockout hasp diameters
- Durable construction with powder coated steel and reinforced polymer for operation in harsh environments

- ML-491B MASTER CIRCUIT BREAKER LOCKOUT (TALL & WIDE TOGGLES)**
- ML-493B MASTER CIRCUIT BREAKER LOCKOUT SINGLE, DOUBLE TOGGLE**
- ML-506 SET OF TWO 491B and 493B GRIP TIGHT CIRCUIT BREAKERS**

No. 496B UNIVERSAL WALL SWITCH LOCKOUT



- Locks out both toggle and Decora paddle wall switches
- Patent-pending innovative design assures switch is locked on or off
- Hinges open for unobstructed normal operation of switch
- Includes English/Spanish and English/French labels

ML-496B MASTER UNIVERSAL WALL SWITCH COVER

No. 468L SEAL TIGHT BALL VALVE LOCKOUT

- Patent-pending innovative design eliminates the risk of valve reactivation by movement of the handle
- With Seal Tight, remove and store the handle and conceal the valve stem for secure lockout
- Universal fit-effectively lock out all valves from 3/8" to 4"
- Works in virtually all valve installations--metal and PVC valves, insulated pipes, pipes mounted close a wall of ceiling and valves with tight access due to close proximity to other valves or pipes
- Easy to use--simple to apply with an intuitive wrapping strap and locking mechanism
- Lightweight, flexible device is easily carried to the job and then folded for compact storage in safety toolboxes
- Includes write-on erasable labels in English, French & Spanish
- Constructed of durable PVC polyester fabric and HDPE plastic
- Performs effectively to withstand corrosive environments and operates in extreme conditions (temperature range -40F to 250F)



ML-468L MASTER BALL VALVE LOCKOUT

No. 480 ROTATING GATE VALVE LOCKOUT



- Outward/inward rotation allows for easier installation and storage
- Surrounds the valve operating handle to protect against accidental valve opening
- Unique patent-pending rotating design allows for easier installation in confined space applications
- Each size rotates into itself and nests into the next larger size to save space in safety tool boxes
- Center knockout can be removed for rising stem gate valves
- Multiple workers can apply their personal safety locks
- Complete with high-visibility permanent safety labels (English, French & Spanish) that can be written-on to identify the responsible person, then erased for the next job
- Tough, lightweight, dielectric Xenoy* thermoplastic bodies withstand chemicals
- Perform effectively in extreme conditions, temperature range -50F (-46C) to 350F (177C)

ML-480 MASTER GATE VALVE LOCKOUT 1 TO 3 INCH HANDLE

ML-481 MASTER GATE VALVE LOCKOUT 2 TO 5 INCH HANDLE

ML-482 MASTER GATE VALVE LOCKOUT 4 TO 6.5 INCH HANDLE

ML-483 MASTER GATE VALVE LOCKOUT 6 TO 10 INCH HANDLE

ML-484 MASTER GATE VALVE LOCKOUT 8 TO 13 INCH HANDLE

ML-485 MASTER GATE VALVE LOCKOUT INCLUDES 1 EACH OF 480 & 484

No. 503RED LATCH TIGHT LOCK BOX

- Storage device captures keys for effective lockout of large equipment
- Exclusive Latch Tight feature ensures that keys cannot be accessed until the last lock is removed
- Durable powder-coated red finish with stainless steel handle
- Integrated storage organizes up to 12 keys or hundred of bulk keys
- Dual application--wall mount or portable
- Up to 14 workers can apply their personal safety padlocks or hasps



ML-503RED MASTER LOCK BOX

No. 418 SAFETY LOCKOUT HASP



- Lockout by multiple workers at each lockout point
- Attach device to energy disconnect switch
- Keeps equipment inoperative while repairs or adjustments are made
- Control cannot be turned on until last worker's padlock is removed from hasp
- Heavy duty pry proof steel, dielectric plastic, dual jaw aluminum
- Dimensions are 2-3/8" X 3-1/4" with 1" inside jaw diameter, holds up to 4 padlocks

ML-418 MASTER HEAVY DUTY HASP

No. 419 SAFETY LOCKOUT HASP



- Lockout by multiple workers at each lockout point
- Attach device to energy disconnect switch
- Keeps equipment inoperative while repairs or adjustments are made
- Control cannot be turned on until last worker's padlock is removed from hasp
- Heavy duty pry proof steel, dielectric plastic, dual jaw aluminum
- Dimensions are 2-3/8" X 6-5/8" with 1" inside jaw diameter, holds up to 8 padlocks

ML-419 MASTER HEAVY DUTY HASP LONG SHACKLE

No. 420 / 421 SAFETY LOCKOUT HASP



420

421

- Lockout by multiple workers at each lockout point
- Attach device to energy disconnect switch
- Keeps equipment inoperative while repairs or adjustments are made
- Control cannot be turned on until last worker's padlock is removed from hasp
- Heavy duty pry proof steel jaw with vinyl coated handle

420- Dimensions are 1-3/4" X 4-1/2" with 1" inside jaw diameter, holds up to 6 padlocks

421- Dimensions are 2-3/8" X 5" with 1-1/2" inside jaw diameter, holds up to 6 padlocks

ML-420 MASTER RED LOCKOUT HASP 1" DIAMETER JAWS

ML-421 MASTER RED LOCK HASP 1 1/2" DIAMETER JAWS

No. 427 SNAP-ON SAFETY LOCKOUT HASP



- Lockout with tagout identification for multiple workers
- Features an easy-to-apply "snap-on" advantage with its spring-loaded locking arm
- Fits more lockout points than alternative rivet-hinge labeled lockout hasp
- Anodized aluminum and stainless steel construction for combined corrosion-resistance and strength
- Complete with high visibility, re-usable write-on safety labels (English, French & Spanish). Identify the responsible person, then erase for the next job.
- Dimensions are 2-7/8" X 7" with 1-3/4" X 2-1/8" inside jaw diameter, holds up to 5 padlocks

ML-427 MASTER ALUMINUM SNAP ON LABELED HASP

No. 429 DUAL JAW ALUMINUM HASP



- Lockout by multiple workers at each lockout point
- Attach device to energy disconnect switch
- Keeps equipment inoperative while repairs or adjustments are made
- Control cannot be turned on until last worker's padlock is removed from hasp
- Dual jaw aluminum hasp
- Dimensions are 2" X 5-7/8" with 1" & 1-1/2" inside jaw diameters, holds up to 8 padlocks

ML-429 MASTER DUAL JAW ALUMINUM HASP

Master SAFETY SERIES Lock.

No. 1456E410 SAFETY LOCKOUT POUCH W/ 410RED PADLOCKS

1456 safety lockout pouch containing:

- 1-7C5RED breaker switch
- 1-420 Lockout Hasp
- 1-No. 410 red xenoy padlock
- 2-493B Grip Tight Lockout devices
for wide or tall breaker toggles
- 1-491B Circuit Breaker Lockout
- 1 bag of 12-497A Danger Tags



ML-1456E410 MASTER PORTABLE LOCKOUT POUCH

No. 1457E410KA SAFETY LOCKOUT CARRY CASE W/ 410 RED PADLOCKS KEYED ALIKE

A 1457 safety carry case containing:

- 1-7C5RED circuit breaker
- 1-420 Lockout Hasp
- 1-427 snap-on hasp
- 1-496B wall switch lockout
- 1 bag of 12-497A Danger Tags
- 3-No. 410 red Xenoy padlocks keyed alike
- 2-491B Grip Tight™ lockout device for wide or tall breaker toggles
- 3-493B Grip Tight™ lockout devices for standard size breaker toggles



ML-1457E410KA MASTER LOCKOUT TOOL BOX W/ COMPONENTS

No. 1482BP410 PADLOCK STATION W/ 4-#410RED PADLOCKS

- 1482** - Safety Lockout covered padlock station w/4-410RED XENOY padlocks, keyed different
Also contains 2-420 hasps and 1-bag (12/bag) of the 497A tags
- 1483** - Safety Lockout Covered padlock station w/10-410RED XENOY padlocks, keyed different
Also contains 2-420 hasps and 2-bags (12/bag) of the 497A tags
- 1484** - Safety Lockout Covered padlock station w/20-410RED XENOY padlocks, keyed different
Also contains 4-420 hasps and 4-bags (12/bag) of the 497A tags

- Exclusive translucent cover protects contents
- Resilient polycarbonate material provides twice the heat resistance and quadruple the impact strength of typical stations
- Reinforced snap-lock clips provide easy padlock and hasp storage and removal.
- PLUS a no-charge Safety Lockout Padlock Key Charting System is available by simply returning the enclosed mail-in card after your purchase. Master Lock will supply a Registered System number, maintain a record of the padlock key cuts provided with your station and ensure that there is no duplication on your future orders
- This is critical for Safety Lockout

ML-1482BP410 MASTER 4 LOCK STATION XENOY LOCKS

ML-1482B MASTER 4 LOCK STATION BOARD ONLY



1482BP410



1482



1483



1484

ML-1483B MASTER 10 LOCK STATION BOARD ONLY

ML-1484B MASTER 20 LOCK STATION BOARD ONLY

No. 410 XENOY PADLOCK FOR SAFETY



- 1-1/2" wide 1-3/4" tall Xenoy black body, shackle w/1-1/2" clearance
- Designed exclusively for Lockout/Tagout applications
- Durable, lightweight, non-conductive Xenoy lock body
- Customize on-site with permanent, write-on labels
- Compliance with OSHA "one employee, one lock, one key" directive
- High security, reserved-for-safety cylinder
- Key retaining-ensures that padlock is not left unlocked
- Keyed different 6-pin tumbler cylinder

- ML-410-BLK-KA-600F401** (BLACK/ KEYED ALIKE)
- ML-410-BLK-KD** (BLACK/ KEYED DIFFERENT)
- ML-410-BLU-KA-600F405** (BLUE/ KEYED ALIKE)
- ML-410-BLU-KD** (BLUE/ KEYED DIFFERENT)
- ML-410-GRN-KA-600F407** (GREEN/ KEYED ALIKE)
- ML-410-GRN-KD** (GREEN/ KEYED DIFFERENT)
- ML-410-ORJ-KD** (ORANGE/ KEYED DIFFERENT)
- ML-410-PRP-KD** (PURPLE/ KEYED DIFFERENT)
- ML-410-RED-KA-600F413** (RED/ KEYED ALIKE)
- ML-410-RED-KD** (RED/ KEYED DIFFERENT)

No. 8611 ADJUSTABLE CABLE LOCKOUT



- Patented pull-tight cable adjusts for a secure fit every time
- Integrated safety hasp and cable is ideal for multiple circuit breaker panel and side-by-side gate valve lockouts
- Tough, flexible multi-stranded 1/4" dia. steel cable is insulated with a clear vinyl coating
- Feed the cable end through the points to be locked out, then back through the lockout body
- Cinch it tight to remove any slack with the patented locking feature
- Tough, lightweight Xenoy thermoplastic body withstands chemicals
- Performs effectively in extreme conditions (-50F to +300F)
- Master Lock No. 8611 includes a 6' cable
- Complete with high-visibility, re-usable, write-on safety labels (English, French & Spanish)
- Identify the responsible person, then erase for the next job

No. 8615 15' CABLE FOR USE W/8611 ADJUSTABLE LOCKOUT



- Separate 15' cable for use with the No. 8611 adjustable cable lockout

ML-8611 MASTER ADJUSTABLE CABLE LOCKOUT (6 FOOT)

ML-8615 MASTER ADJUSTABLE CABLE LOCKOUT CABLE (15 FOOT)

No. 497A ENGLISH "DO NOT OPERATE" TAG



- Heavy duty tags comply with OSHA lockout/tagout standard
- Durable polyester laminate resists water, grease and extreme temperatures
- Heavy duty construction withstands over 50 lbs. (23 kg) of pullout force (meets OSHA requirement)
- Customize with name, department, expected completion
- 7/16" (1.1cm) dia. brass grommet accepts all safety padlocks
- One item consists of 1 bag with 12 tags and 12 ties in English
- Dimensions 5-3/4" (14.6cm) X 3-1/8" (7.9cm)

ML-497A MASTER LOCKOUT SAFETY LOCKOUT TAGS (12 TAGS/PACK)

No. 4720 STEERING WHEEL COVER



- 16" (40.6cm) & 20" (0.5m) Steering wheel covers provides visual deterrent for vehicle maintenance
- Trilingual warning (English, French and Spanish) notifies employees not to start or move vehicle
- Lock in place with a 421 hasp and safety padlock
- For added security use Safety Series 8611 lockout cable around steering wheel and foot pedals

ML-4716 MASTER 16' DIAM. STEERING WHEEL COVER

ML-4720 MASTER 20' DIAM. STEERING WHEEL COVER

DOUBLE "D" PUNCH & DIE SET



MJ-MDPS-4
PUNCH & DIE
SET FOR A DOUBLE D HOLE
CUT-OUT

Major Manufacturing's punch and die set will punch a DOUBLE "D" hole in sheet metal cabinet drawers and doors. A must have for the locksmith working on vending machines, lockers, metal cabinets or any type of sheet metal door made with 18 guage (.048) or lighter steel. To use, simply drill a 1/2" hole centered where the cam lock is to be installed, slide the punch through the hole and tighten down the hex nut with a 11/16" wrench or socket set. MDPS-4 punches a DOUBLE "D" hole size .645 wide by .770 high. For use with standard cam locks.

SECURITY HINGE PINS



MJ-JP-12
SECURITY PIN FOR
OUT SWING DOORS
(2 PINS PER PACK)

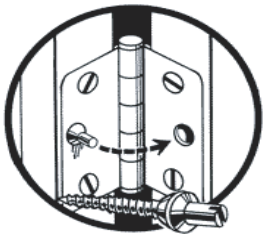

For commercial hinges using #12 screw. Simply remove one opposing screw from each hinge leaf and replace with the proper size Jamb Pin. Secures door in jamb when closed if hinge pin is removed. For use on wood or metal doors and jambs. Jamb Pins have a combination wood and machine thread. Machine screw thread is 12-24. 2 pins per pack.



MJ-A100-KA-MMC11
(KNOB)

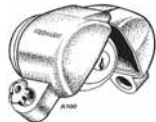

KEE-BLOK

Blocks all existing keys to a knob-lock in seconds!
*New Added Feature! Fits Over Padlocks
To Block Out Existing Keys!*

OCTOPOD

5002 Series Single Point / 1 Locking Rod. Aluminum Powdercoat - 9" Locking Rod. A 360 degree rotation of the key will drive the locking rod 2 3/8 inches. All required parts for installation supplied including three rod guides and both Phillips and one-way screws, mortise cylinder is not included. Requires a 1 1/8 inch mortise cylinder.

MJ-5002-1-9A SCHLAGE GEAR
MJ-5002-2-9A MEDECO GEAR
MJ-5002-GR2 #2 MEDECO GEAR ONLY



FILE CABINET LOCKING BARS

File cabinet locking bar mounts on left hand side of cabinet for standard applications. Will not block adjoining cabinets in either locked or unlocked position. Red tape strip on inside of locking bar indicates unlocked position and protects painted finish on filing cabinet when locked. May also be used to lock sliding drawers on rollaway cabinets or any cabinet with steel drawers. Individually boxed with fasteners, padlock not included.



- | | |
|-----------------|-----------------------------|
| MC-SA200 | 23-1/2" FOR 2 DRAWER |
| MC-SA300 | 33" FOR 3 DRAWER |
| MC-SA400 | 49-1/2" FOR 4 DRAWER |
| MC-SA500 | 55" FOR 5 DRAWER |

PATIO DOOR GUARD



PATIOGUARD WITH HANDLE

The PatioGuard lock has a handle on the outside to accept either Schlage or Weiser keys. Finishes are available in brown and white. This can be a replacement for a broken handle. The lock will work on doors up to 2 inches thick, and fits a wide variety of applications.

MI-NOH10-SC	SCHLAGE KWY. BROWN
MI-NOH10-WR	WEISER KWY. BROWN
MI-NOHW-SC	SCHLAGE KWY. WHITE
MI-NOHW-WR	WEISER KWY. WHITE



PATIOGUARD

NDS models provide a hook lock and a deadlocking feature for sliding glass doors. The latch is designed to hold the locking device so that it cannot be lifted out of place. This lock is ideal for replacing the old "AGE" lock or similar type locks. Most popular usage is for sliding doors that need outside keys, such as town homes, mobile homes, camper shells or tops and even swinging doors, or screen doors.

MI-NDS10B4-KA-905	BROWN
MI-NDSWT4-KA-905	WHITE



SLIDEGUARD

"Slideguard" can be applied to glass, wood, or Plexiglas surfaces. This product has successfully proven itself for more than twelve years. It increases security tremendously.

GLASS/METAL CABINET LOCK	PLEXIGLASS CABINETS LOCK
MI-SLG014-KA-M952	MI-SLGZ015-KA-M952
MI-SLG014-KD	MI-SLGZ015-KD



SLIDEGUARD

The VSLGZ utilizes a bent or "Z" tailpiece to overlap and brace against the frame of the door or window to be secured. Due to the 1/2" clearance, the VSLGZ lock was designed to be used on sliding doors of display cases as well as the thinner windows of trucks, boats, and RVs. In most instances no tools are required to install the VSLGZ SlideGuard Convenience series locks. ****Two keys are provided with each lock purchased.****

GLASS/METAL CABINET LOCK

MI-VSLGZ15-KA-M952	PLEXIGLASS CABINET LOCK WITH ZEE BRACKET (KA)
MI-VSLGZ15-KD	PLEXIGLASS CABINET LOCK WITH ZEE BRACKET (KD)
MI-VSLG014-KA-M952	SLIDING GLASS/METAL CABINET LOCK (KEYED ALIKE)
MI-VSLG014-KD	SLIDING GLASS/METAL CABINET LOCK (KEYED DIFFERENT)
MI-VFG780-KA-M952	THRU-THE-GLASS DOOR LOCK (KEYED ALIKE)
MI-VFG780-KD	THRU-THE-GLASS DOOR LOCK (KEYED DIFFERENT)



19 SERIES RIM PANIC DEVICE

The Monarch 19-R Series rim device that delivers superior panic hardware with modern touchbar styling. This non-handed device covers a 161 cutout and may be used on 13.4" narrow stile aluminum doors. The Exit Only device is ready to accept any trim function shown

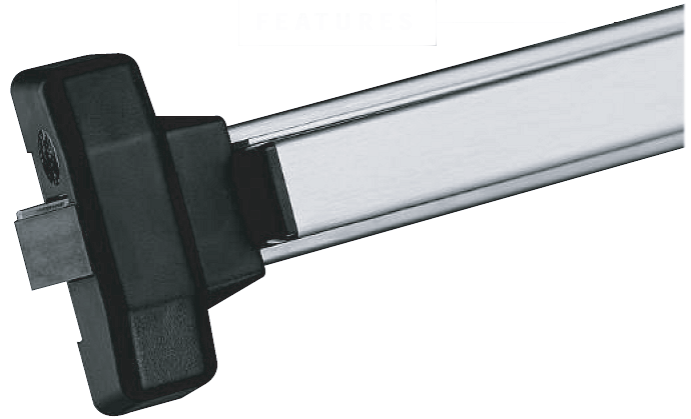

- | | |
|---------------------|---------------------------------|
| MO-19-R-EO-3'-SP28 | UP TO 32" DOOR WIDTH, ALUMINUM |
| MO-F19-R-EO-3'-SP28 | FIRE-RATED, 32" WIDTH, ALUMINUM |
| MO-19-R-EO-4'-SP28 | 48" DOOR WIDTH, ALUMINUM |
| MO-19-R-EO-4'-SP313 | 48" DOOR WIDTH, DURADONIC |

TRIMS



PASSAGE THUMBPIECE
MO-910TP-BE-SP28

LOCKABLE THUMBPIECE
MO-910TP-CONTROL-SP28



CLASSROOM FUNCTION
MO-914-KIL-KD-US32D

19 SERIES VERTICAL ROD RIM PANIC DEVICE

Manufactured to the same exacting standards as the 19 Rim, the 19-V Exit Device complies with most exit door requirements, and is fully reversible and surface applied. This device is regularly furnished with deadlocking top latch with latch retention and square bolt at bottom.



- | | |
|------------------------|--------------------------------|
| MO-19-V-EO-3'-SP28-LHR | VERTICAL ROD EXIT DEVICE (LHR) |
| MO-19-V-EO-3'-SP28-RHR | VERTICAL ROD EXIT DEVICE (RHR) |

PARTS



MO-565-626

19RBA STRIKE
Adjustable surface mounted for use with blade or applied stops. Mounts flush for 1/2" stop height.



MO-571-26D

DOUBLE DOOR STRIKE
Used on inactive leaf for device on active leaf of pair of doors without removable mullion.



END CAP AND MOUNTING BRACKET
MO-6135-BLK



CYLINDER DOGGING KIT
MO-K19CD-LONG-MAL 48" BAR
MO-K19CD-SHORT-MAL 32" BAR

DISC TUMBLER CAM LOCKS



8051



8052, 8053, 8054, 8055



8060

- APPLICATION:** For drawers, R.H. or L.H. doors with lipped/overlay construction (straight cam) or flush construction (formed cam). For overlay application, the combined thickness of front and frame cannot exceed the cylinder length.
- OPERATION:** 90° cam turn on all locks. Key removable in both locked and unlocked positions.
- KEYING:** Will key together with all other disc tumbler locks using D8785 key blank.
- PACKAGING:** Supplied with two keys, trim washer, spur washer (for wood), mounting nut and two cams.

PART#	CYLINDER LENGTH	FINISH
NA-C8051-14A-KA-C415A	7/16"	BRIGHT NICKEL
NA-C8051-14A-KD	7/16"	BRIGHT NICKEL
NA-C8052-14A-KA-C415A	5/8"	BRIGHT NICKEL
NA-C8052-14A-KD	5/8"	BRIGHT NICKEL
NA-C8053-14A-KA-C415A	1-3/16"	BRIGHT NICKEL
NA-C8053-14A-KD	1-3/16"	BRIGHT NICKEL
NA-C8054-14A-KA-C415A	15/16"	BRIGHT NICKEL
NA-C8054-14A-KA-C390A	15/16"	BRIGHT NICKEL
NA-C8054-14A-KD	15/16"	BRIGHT NICKEL
NA-C8054-14A-KA-C420A	15/16"	BRIGHT NICKEL
NA-C8055-14A-KA-C415A .	1-7/16"	BRIGHT NICKEL
NA-C8055-14A-KD	1-7/16"	BRIGHT NICKEL
NA-C8060-14A-KA-C415A	1-3/4"	BRIGHT NICKEL
NA-C8060-14A-KD	1-3/4"	BRIGHT NICKEL

NA-C8070-2C	CIRCUIT BREAKER LOCK
NA-C8133-26D-KA-101	HALF MORTISE DRAWER LOCK
NA-C8803-14A-KD	DRAWER LOCK DIAMOND BACK

KEYING KITS



NA-V70P-1
Pin Tumbler Keying Kit
 Includes: 100 Pcs. ea. 1, 2, 3 and 4 Drivers.
 100 Pcs. ea. 0, 1,2, 3, 4, 5, 6, 7, 8 and 9 Tumblers.
 250 Pcs. Tumbler Springs
 100 Pcs. Tumbler Retainers



NA-V70P-2
Pin Tumbler Master Keying Kit
 Includes: 100 Pcs. ea. 2, 3,4,5,6,7,8
 and 9 Master Drivers.



NA-V71D-3
Disc Tumbler Keying Kit
 Includes: 100 Pcs. ea. 00, 22, 44 and 66 Tumblers.
 250 Pcs. Tumbler Springs.



NA-V71D-4
Disc Tumbler Master Keying Kit
 Includes: 100 Pcs. ea. 02, 04, 06, 20, 24, 26,40,42,
 46, 60, 62 and 64 Tumblers. 250 Pcs. Tumbler
 Springs

KEY BLANKS



NA-KBBD4291



NA-KBBD4292



NA-KBBD8785



NA-KBBD8590
**FREEZER CHEST
 KEY BLANK**

CHEST LOCK

APPLICATION - Lid locks for cedar chest application and other lid locking requirements. C8414 is surface mounted and requires a 9/16" dia. hole for cylinder.
OPERATION - Key removable in both locked and unlocked positions. C8414 has a safety feature requiring operation of pushbutton to lock or latch lid closed.
KEYING - Each lock furnished keyed alike.
PACKAGING - Supplied with one key.



NA-C8414-4G-KA ANTIQUE BRASS, KEYED ALIKE

GANG LOCKS

APPLICATION - For locking drawers in desk pedestals and other multiple drawer applications. Requires 7/8" dia. hole for cylinder and dado for bar, measuring 7/8" x 1/8" deep on inside of panel.

OPERATION - Key removable in both locked and unlocked positions. Turning the key locks all drawers simultaneously (drawers must be in closed position). Bar moves studs into notch in drawer or slide, thus preventing drawer movement.

KEYING - Will key together with all other disc tumbler locks using 08785 key blank.

PACKAGING - Supplied with two keys, three locking studs, three stud slides, saddle and mounting screws.



NA-D8090-4G-KD ANTIQUE BRASS

CODE BOOKS



NA-D8001 Pin Tumbler Key Codes

Includes the most popular National key codes: GM1 series, GM2series, GM2A series, GM300 series, GM600 series and GM700 series.



NA-D8002 Disc Tumbler and Lever Tumbler Key Codes

Includes the most popular National key codes: standard 4 tumbler series. standard 5 tumbler series, standard 6 tumbler series, 5 tumbler prefix: RO series, 5 tumbler prefix GF series, 5 tumbler prefix SK and KS series, 6 tumbler prefix SK and KS series and 5 lever tumbler series 8LLT.

DRAWER LOCKS

APPLICATION - For drawers, R.H. or L.H. doors. Surface mounted. Requires '57/64" diameter hole for cylinder.

OPERATION - Key removable in both locked and unlocked positions.

KEYING - Will key together with all other pin tumbler locks using 04291 key blank.

PACKAGING - Supplied with two keys, strike and mounting screws.



NA-C8177-26D-KA-915

1-1/8" CYLINDER LENGTH

NA-C8177-26D-KD

1-1/8" CYLINDER LENGTH

NA-C8178-26D-KA-915

7/8" CYLINDER LENGTH

NA-C8178-26D-KD

7/8" CYLINDER LENGTH

APPLICATION - For drawers and doors. Surface mounted.

Requires 7/8" dia. hole for cylinder.

OPERATION - Key removable in both locked and unlocked positions.

KEYING - Will key together with all other disc tumbler locks using 08785 key blank.

PACKAGING - Supplied with two keys and mounting screws.



NA-C8703-3-KA-C415A

BRASS

NA-C8703-3-KD

BRASS

APPLICATION - Used on furniture and other fine cabinetry. C8826 is surface mounted and requires hole for key entry.

OPERATION - Key removable in both locked and unlocked positions.

KEYING - Each lock furnished keyed alike.

PACKAGING - Supplied with one key. C8826 is supplied with strikes. Key hole escutcheons are packed with C8826.



NA-C8826-3A-KA

BRASS

"L" HANDLES

APPLICATION - For doors on metal lockers and cabinets. For R.H. doors, install with escutcheon vertical. For L.H. doors, install with escutcheon horizontal. Spindles can be cut to fit special requirements.

OPERATION - Key removable in both locked and unlocked positions.

KEYING - Will key together with all other disc tumbler locks using D8785 key blank.

PACKAGING - Supplied with two keys and mounting hardware.

NA-C8759-26D-KA-C413A
DULL CHROME

NA-C8759-26D-KD
DULL CHROME



FREEZER HANDLES

APPLICATION - Handle mounts on edge of freezer and cooler doors. Reversible for R.H. or L.H. doors.

OPERATION - Key removable in both locked and unlocked positions. Handle can be used as latch until locked with key.

KEYING - Keyed alike to XC-3.

PACKAGING - Supplied with two keys, strike mounting plate and strike. Mounting screws not furnished.



REPLACEMENT PLUGS

NA-C8763-26-KA-XC3

OLD STYLE PLUG

NA-C8765-26

CHROME, KEYED ALIKE

NA-C8764-26-KA

NEW STYLE PLUG (C8765)

DISC TUMBLER BYPASS LOCKS



APPLICATION - For wood sliding doors. Requires a 7188 dia. hole in front door for cylinder.
OPERATION - pushing in cylinder locks doors. Key removable in both locked and unlocked positions.
KEYING- Will key together with all other disc tumbler locks using 08785 key blank. See table for keying.
PACKAGING - Supplied with two keys, strike and mounting screws.

NA-C8043-26D-KA-C415A
 NA-C8043-26D-KD

DULL CHROME
 DULL CHROME

KEYED ALIKE
 KEYED DIFFERENT

BRASS
 BRASS

PIN TUMBLER SHOW CASE LOCKS



APPLICATION - C8140 is for sliding glass doors.
OPERATION - key removable in locked position only.
KEYING - Will key together with all other pin tumbler locks using 04291 key blank.
PACKAGING - Supplied with two keys.

NA-C8140-26D-KD
 NA-C8140KA-101
 NA-C8140KA-103

KEYED DIFFERENT
 KEYED ALIKE
 KEYED ALIKE

LID LOCKS



APPLICATION -Requires 11/32" wide x depth of lock full mortise, plus hole for key entry.
OPERATION - Key removable in both locked and unlocked positions.
KEYING - Each lock furnished keyed alike.
PACKAGING - Supplied with one key. Appropriate strikes and mounting screws supplied with locks with additional keyhole escutcheon furnished with C8384.

NA-C8384-3A DULL BRASS

MAILBOX LOCKS



8715



8730



8735

NA-C8715
 NA-C8730
 NA-C8735

MAILBOX LOCK WITH CAM
 MULTI CAMS
 MULTI CAMS AND DUST COVER

1601 DOOR CLOSER

Features

- Non-handed
- Adjustable spring sizes 3 through 6
- Rack-and-pinion design
- Cast aluminum body
- 2-7/8" (73mm) projection
- 1-3/8" (35mm) diameter piston
- 5/8" (16mm) diameter pinion journals
- Standard, separate and independent, latch, sweep and backcheck intensity valves
- Tri-Style® packaging (regular arm, top jamb and parallel arm mounting)
- All standard arm applications allow doors to swing 180°, conditions permitting
- Marked valves



NO-1601-689 SIZED 3-6, SPRAYED ALUMINUM

8501 HEAVY DUTY DOOR CLOSER

Features

- Non-handed
- Staked valves
- Cast aluminum body
- Rack-and-pinion design
- 1-1/4" (32mm) diameter piston
- Adjustable spring sizes 1 through 6
- 5/8" (16mm) diameter pinion journals
- Standard, separate and independent, latch, sweep and backcheck intensity valves
- 2-1/8" (54mm) projection (standard covers)
- All standard arm applications (with slim, full or metal covers) allow doors to swing 180 degrees, conditions permitting
- Shipped with full plastic cover
- Full size template



NO-8501-689 HEAVY DUTY, SPRAYED ALUMINUM

9300BC SERIES DOOR CLOSER

The 9300BC is a light commercial door closer designed for exterior and interior doors such as condominiums, apartments, motels or hotels.

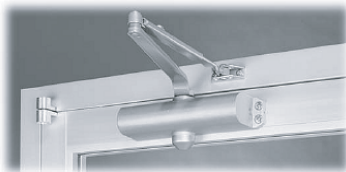

FEATURES

- Spring size 3, 4
- Separate and independent valve for sweep speed and latch speed
- Adjustable backcheck standard
- Regular and top jamb mounting
- UL listed
- UL10C compliant
- ANSI/BHMA A156.4, Grade 3

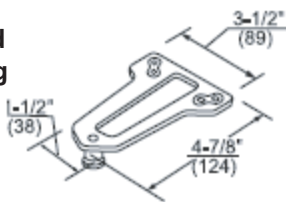

NO-9303BC-9318A-689 PARALLEL ARM INCL. SIZE 3
 NO-9304BC-9318A-689 PARALLEL ARM INCL. SIZE 4

7501 HEAVY DUTY DOOR CLOSER

Features

- Non-handed
- Rack-and-pinion design
- Cast aluminum body
- 2-1/8" (54mm) projection
- 1-1/2" (38mm) diameter piston
- 5/8" (16mm) diameter pinion journals
- Staked valves
- Standard, separate and independent, latch, sweep and backcheck intensity valves
- Backcheck positioning valve
- NorGlide® fluid
- Molded plastic cover
- All standard arm applications allow doors to swing 180°, conditions permitting
- Self-drilling screws
- Full-size template
- Heavy-duty arm: Unitrol® Can be used for either parallel arm or top jamb applications. Unitrol arms combine the features of a double lever arm overhead door stop/holder with the backcheck feature of the door closer to reduce door stopping shock loads to a minimum.



NO-UNI7501-689 GRADE 1, HEAVY DUTY

CUPBOARD DOOR LOCK

Easily rekeyable via set screw
cylinder release mechanism
Solid brass pin tumbler cylinder
drilled for 6 pins
ANSI/BHMA No. E07121
Barrel lengths: 1-3/8"
Barrel diameter: 7/8"
US4 finish



OL-500DR-4-78-KA-4T3
OL-500DR-4-78

CCL KQY, KA 4T3
CCL KQY, KD

CUPBOARD DOOR LOCK

Easily rekeyable via cylinder release mechanism
Will accept other manufacturer's SCHLAGE
compatible deadbolt cylinders
Barrel lengths: 1-1/8"
Barrel diameter: 1-1/8"
Bolt projection: 15/16"
26D finish



OL-700SC-26D SCHLAGE 'C' KQY

DRAWER LOCK

Easily rekeyable via cylinder release mechanism
Will accept MEDECO deadbolt cylinders
Barrel lengths: 1-3/8"
Barrel diameter: 1-1/8"
Bolt projection: 15/16"
26D finish

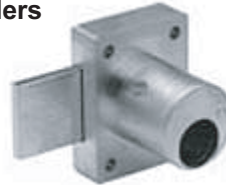

OL-700LCM-26D 1-3/8", FOR MEDECO KEY IN KNOB

I/C (SFIC) DRAWER LOCK

Field reversible - includes all parts necessary to convert to a drawer lock
Similar to Best original 3L series
Accepts Best, Arrow, Falcon IC cores
Barrel diameter: 1-1/8"
Barrel length 1-1/4"
26D finish



OL-721DR-US26D I/C CORE DRAWER LOCKS (BEST I/C)

700 SERIES SPACERS

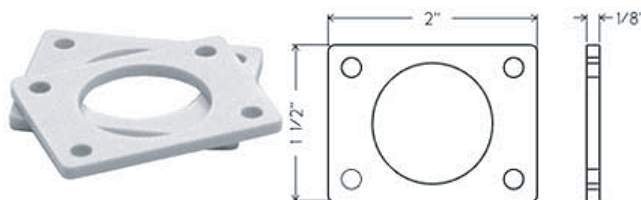

OL-10-350 PLASTIC SPACER FOR 700 SERIES

CAM LOCKS



TUBULAR NICKEL SILVER CAMLOCKS

- PU-1011 137 KWY 7/8" CAMLOCK
- PU-1021KA-X5301 137 KWY 1-18" CAMLOCK, KEYED ALIKE



NICKEL SILVER CAMLOCKS

- PU-2006 3/8"
- PU-2006KA-151 3/8", KEYED ALIKE
- PU-2006KA-201 3/8", KEYED ALIKE
- PU-2011 5/8"
- PU-2011KA-151 5/8", KEYED ALIKE
- PU-2011KA-201 5/8", KEYED ALIKE
- PU-2021 7/8"
- PU-2021KA-201 7/8", KEYED ALIKE
- PU-2031 1-1/8"
- PU-2031KA-151 1-1/8", KEYED ALIKE
- PU-2031KA-201 1-1/8", KEYED ALIKE
- PU-2031KA-301 1-1/8", KEYED ALIKE

BYPASS LOCKS

NICKEL SILVER BYPASS LOCKS

- PU-2051
- PU-2051KA-151, KEYED ALIKE
- PU-2051KA-201, KEYED ALIKE
- PU-2051KA-301, KEYED ALIKE



DISC TUMBLER DRAWER LOCKS



2061

- PU-2061 DRAWER LOCK, KEYED DIFFERENT
- PU-2061KA-151 DRAWER LOCK, KEYED ALIKE
- PU-2061KA-201 DRAWER LOCK, KEYED ALIKE
- PU-2061KA-301 DRAWER LOCK, KEYED ALIKE



2065

- PU-2065 REMOVABLE BACK DRAWER LOCK
- PU-2065KA-201 REMOVABLE BACK DRAWER LOCK, KEYED ALIKE
- PU-2065KA-301 REMOVABLE BACK DRAWER LOCK, KEYED ALIKE



2071

- PU-2071KA-101 METAL DRAWER LOCK, KEYED ALIKE
- PU-2071KA-201 METAL DRAWER LOCK, KEYED ALIKE
- PU-2071KA-301 METAL DRAWER LOCK, KEYED ALIKE

DISC TUMBLER DRAWER LOCKS



- PU-3003 2" FILING CABINET LOCK WITH A SQUARE BOLT
- PU-3003KA-151 2" FILING CABINET LOCK WITH A SQUARE BOLT
- PU-3003KA-201 2" FILING CABINET LOCK WITH A SQUARE BOLT

- PU-3006 1-3/4" FILING CABINET LOCK WITH A ROUND BOLT
- PU-3006KA-201 1-3/4" FILING CABINET LOCK WITH A ROUND BOLT



MAILBOX LOCKS FOR RIOPEL

NICKLE SILVER AND
COMES WITH OFFSET CAM

PU-4011 RIOPEL MAILBOX LOCK

SPECIALTY LOCKS



PU-2511K-KA300
PU-2511K

PIN CAM FURNITURE LOCK
PIN CAM FURNITURE LOCK



PU-5211K10EL
PU-5211K10ELKA-W501



DOVETAIL EXTENSION CAM LOCK
DOVETAIL EXTENSION CAM LOCK

FURNITURE LOCKS



PU-988-14-11-KA-549 DIAMOND BACK DRAWER LOCK (1-1/4 LONG BARREL)



PU-970-353-KA-532 SMALL DIAMETER DRAWER LOCK (BLACK FACE)
PU-970-353-KD SMALL DIAMETER DRAWER LOCK (BLACK FACE)



STEELCASE LATERAL FILE CABINET

PU-LATERAL-FILE-LKKA-W501
PU-LATERAL-FILE-LOCK-KD



FOR GLOBAL WITH PIN CAM

PU-G2176-KD
PU-G2176-KA-W413



PANEL LOCK

WITH PIN CAM
PU-P2170-KD
PU-P2170-KA-W513

T-HANDLE



PU-9006 T HANDLE WITH POSTS (1-1/2 C.C.)

PARTS

PU-PD1005	CAM LOCK HEX LOCKING NUT
PU-SL18426	SPUR TYPE WASHER FOR WOOD
PU-MASTERKEY	PUNDRA MASTER KEY
PU-REMOVAL/KEY	CYLINDER REMOVAL CUT KEY

RAYOVAC

RAYOVAC



"Rayovac Alkaline Batteries provide long lasting performance in commercial applications, plus the best value for the money."



HA-AL-AA

"AA" Alkaline Batteries, 8 PACK
sold in packs of 8 only



HA-AL-AAA

"AAA" Alkaline Batteries, 8 PACK
sold in packs of 8 only



HA-AL-9V

"9 Volt" Alkaline Batteries, 6 PACK
sold in packs of 6 only

HA-AL-C

"C" Alkaline Batteries, 6 PACK
sold in packs of 6 only

HA-AL-D

"D" Alkaline Batteries, 6 PACK
sold in packs of 6 only

Long-Lasting Power for Less!

Frequently Asked Questions

1. Can old and new batteries be mixed in a single device?

No. Never mix old and new batteries in a device. Battery leakage may occur. Replace all batteries in a device at the same time.

2. Can different battery types be mixed in a single device?

No. Never mix battery types in a device. Battery leakage may occur. Examples of battery types are alkaline, heavy duty, rechargeable.

3. Can batteries be stored in devices for long periods of time?

No. Batteries should be removed from any device that will be stored for long periods of time.

4. Where should batteries be stored?

Batteries should be stored in a cool, dry location. Avoid temperature extremes. Keep batteries in original package until you are ready to use them.

5. How does the cold affect batteries?

Batteries cannot deliver much power when they are cold. You may find that the flashlight kept in your car, in the middle of winter, casts a faint beam. Let the batteries warm up to normal temperature, and try them again before you decide to replace the batteries.



RIOPEL MAILBOXES

THE STANDARD... BY WHICH OTHERS COMPARE

RIOPEL mailboxes combine quality, security and performance to provide a superior mailbox with unequaled reputation across Canada!



SURFACEMOUNT INTERIOR WITH FLUSH FRONT HOUSING

COMPARTMENTS:	H.15-1/2" (394) W. 5" (127) D. 6-1/2" (165)
DOOR THICKNESS:	Stainless steel and brass 5/64". Aluminum 1/8". Solid doors with weather proof locks.
SECURITY:	Crown lock security bracket for protection from prying. Secure door hinging on all models. 5 pin cam locks with 2 keys in each door.
DOOR IDENTIFICATION:	Name and number slot on door.
MOUNTING:	Full surface mounting (Interior and Exterior)
FINISH:	Stainless steel with a highly polished satin finish and protected with a PVC plastic sheet peeled off after installation. Stainless Steel offers the best protection from abuse, lasts a lifetime and is highly attractive.

RIOPEL surface mounting mailboxes are fully assembled avoiding the expense and time to assemble and install a separate kit.

- RI-3210C RIOPEL 3 GANG SURFACE MOUNT MAILBOX (STAINLESS STEEL)**
- RI-3210D RIOPEL 4 GANG SURFACE MOUNT MAILBOX (STAINLESS STEEL)**
- RI-3210E RIOPEL 5 GANG SURFACE MOUNT MAILBOX (STAINLESS STEEL)**
- RI-3210F RIOPEL 6 GANG SURFACE MOUNT MAILBOX (STAINLESS STEEL)**

ELECTRIC STRIKES

4 SERIES



- Fail Locked - UL Listed
- Use with Centerline Mortise Exit Devices, Cylindrical or Centerline Mortise Locks
- 11-16VAC, 12 or 24VAC/DC
- Non-handed
- Accommodates 3/4" latch projection
- Stainless steel faceplates
- Modular Design
- Deadlocking ensured (F-model)
- Grade 3, 500lbs Static Strength, 70ft lbs Dynamic
- Strength, 250,000 Endurance Cycles

FACEPLATES

RU-E4-7-4SC9
(ASA CUT OUT)

RU-E4-7-7RC9
(6-7/8"X 1-1/4")

RU-E4-7-8RC9
(7-15/16"X 1-7/16")

RU-E4100-01 11-16V AC/DC, FAIL SECURE
 RU-E4100-05 12V AC/DC, FAIL SECURE
 RU-E4100-08 24V AC/DC, FAIL SECURE

7 SERIES



- 7104 Fail Locked - UL Listed
- Use with Narrowline Aluminum, Cylindrical or Centerline Mortise and Centerline Mortise Exit Devices
- Accommodates 5/8" latch projection
- 11-16VAC, 12 or 24VAC/DC
- Non-handed
- Stainless steel faceplates
- Modular Design
- Deadlocking ensured
- Grade 3, 500lbs Static Strength, 70ft lbs Dynamic Strength, 250,000 Endurance Cycles

RU-7104-05D-32D ADJUSTABLE LIP (12VDC/ANSI), FAIL SECURE
 RU-7104-08D-32D ADJUSTABLE LIP (24VDC/ANSI), FAIL SECURE

EC241- FIRE RATED



- Fail Locked - cULus Listed
- 1-1/4" x 4-7/8" (31.8mm x 123.8mm)
- Use with Narrowline Aluminum, Cylindrical or Centerline Mortise Locks and Centerline Mortise Exit Devices
- For Aluminum Frames
- Fire-Labeled - UL 10C (1-1/2 hr.)
- 12 or 24VAC/DC
- Accommodates 3/4" latch projection
- Non-handed
- Stainless steel faceplates
- Modular Design
- Deadlocking ensured

RU-EC241-12VDC-R4-630 EFF EFF, FIRE RATED, HEAVY DUTY

AS65 / AL65 SERIES

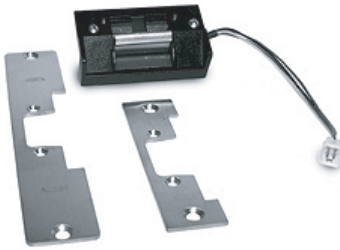

- Field selectable voltage (12 or 24VDC and 12 to 24VAC)
- AS65-Standard version (1-3/16" depth, 3/4" Latch)
- AL65-LOW PROFILE version (1-1/16" depth, 5/8" Latch)
- Low Profile version (1-1/16" depth)
- Horizontal adjustability (up to 1/4")

- Plug-in wire connectors
- Latch Monitor/Keeper Monitor
- Switch Option
- Tested to over 1,000,000 cycles
- Dynamic forces tested to 70 ft. lbs.
- UL Listed 1034 Burglary

STANDARD PROFILE

RU-AS65 12-24VAC/DC
 RU-B608-32D FACEPLATE 1-7/16"W X 7-15/16"H
 RU-B614-32D FACEPLATE 1-1/4"W X 4-7/8"H

LOW PROFILE

RU-AL65 12-24VAC/DC

RETRO-FIT ELECTRIC STRIKES



EDWARDS #9

- Light use with cylindrical locks up to 5/8" latch projection.
- Use for Centerline Latch Entry on Wood or Metal Frames.
- 8-16VAC
- FAIL SECURE

RU-15BS-01-26D 8-16 VAC/DC



PESO 710

- Light use with cylindrical locks up to 5/8" latch projection.
- Use for Centerline Latch Entry on Wood or Metal Frames.
- 8-16VAC
- FAIL SECURE

RU-15CA-01-28 8-16 VAC/DC

RIM ELECTRIC STRIKES



- Fail Locked - UL Listed
- 1-3/4" x 9"(44.5mm x 228.6mm)
- Use with Rim Exit Devices with Pullman Latches
- For Hollow Metal, Aluminum or Wood Frames (Optional Double Door Housing for pairs of doors - Specify 0161DDH)
- Universal design accomodates most manufacturer's exit devices
- Extensive horizontal adjustment
- Accommodates 1/2" to 3/4" Pullman latch projection
- Fully reversible (non-handed)
- 12VAC/DC or 24VAC/DC
- 32D Brushed Stainless Steel finish

RU-0161-05	RIM PANIC ELECTRIC STRIKE 12VAC/DC
RU-0161-08	RIM PANIC ELECTRIC STRIKE 24VAC/DC
RU-DH-01	DOUBLE DOOR HOUSING FOR 0161

ELECTROMAGNETIC LOCKS

8310 For Single Outswinging Interior or Perimeter Doors
1-5/8"D x 2-7/8"W x 10-1/2"L (dimensions include 1/4" mounting bracket)

8320 Double Outswinging Interior or Perimeter Doors
1-5/8"D x 2-7/8"W x 21"L (dimensions include 1/4" mounting bracket)

- Adjustable keyhole mounting
- Convenient plug-in wiring terminals
- Built-in delayed relock feature (0-110 seconds)
- Field selectable voltage 12/24VDC
- Up to 1500 lbs. (680 kg.) holding force
- Easy-access wiring cavity
- Stabilizing 4-bolt "Drop-Stop" mounting
- Low-voltage detection
- Optional sensors (SCS, DSS)
- Self-drilling tek™ fasteners
- MOV surge protection
- Brushed Anodized Aluminum or Brushed Dark Bronze finish
- cULus Listed

RU-8310-C28	MAGNETIC LOCK 12VDC/24VDC
RU-8310-DSS-28	MAGNETIC LOCK WITH DOOR STATUS SWITCH, 12/24VDC
RU-8310-SCS/DSS-28	MAGNETIC LOCK, SECURITY CONDITION SENSOR/DSS
RU-8320-DSS-28	MAGNETIC LOCK, DOUBLE DOOR/DOOR STATUS SWITCH
RU-TJ-10-28	Z- BRACKET FOR 8310 MAGNET

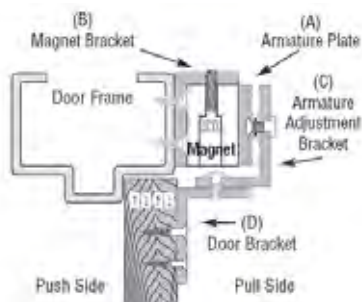

RU-TJ-10-28
Z- BRACKET FOR 8310

TD365 TIMER

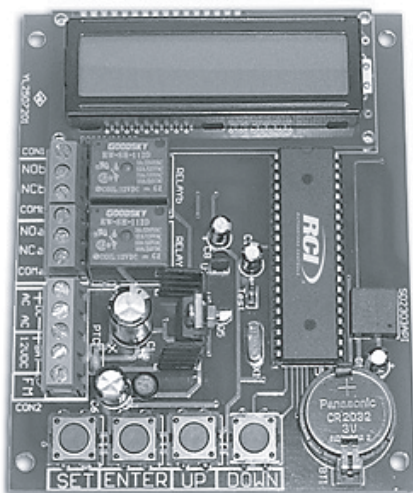

- TD365 - 3.7" x 4.7" x 1" (95mm x 120mm x 25mm)
- 24 hr, 365 day timer for individual daily events
- 2 momentary or latching form "C" relays to control locks and other electronic devices
- Large alphanumeric backlit LCD display for easy programming
- 16 characters by 2 line LCD
- "First Person In" feature to prevent unattended open doors
- EEProm Memory for safe storage of data (all data is stored in the event of a power failure)
- 40 programmable holidays to override regular schedule
- 99 Daily/Weekly events for flexibility and versatility
- Automatic Voltage Selection 12 to 24 VAC or DC
- Built in battery charger circuit allows for addition of stand by battery
- High current capabilities

RU-TD365 RCI 365 DAY EVENT TIMER (12/24VACDC)

POWER SUPPLY

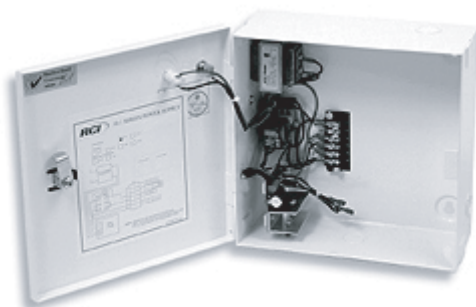

- 1012FPD-1A
- 12VDC, 1 Amp, ULC Listed
- 10-1/4"H x 10-1/4"W x 4"D (260.4mm x 260.4mm x 101.6mm)
- With Fire Panel Disconnect (incl. external utility box)
- Instant unlock upon AC failure*
- Filtered DC output
- Regulated DC Output
- Short Circuit Protection
- Adjustable Output Voltage
- Fuse Protection

RU-1012NR-1AMP-12VDC POWER SUPPLY (1 AMP/12VDC)

TRANSFORMERS AND RECTIFIERS



- | | |
|--------------|-------------------------------------|
| RU-TRANS-001 | 12VAC TRANSFORMER (WIRE IN TYPE) |
| RU-TRANS-002 | 12VAC TRANSFORMER (PLUG IN TYPE) |
| RU-TRANS-004 | 24VAC TRANSFORMER (WIRE IN TYPE) |
| RU-TRANS-005 | 24VAC TRANSFORMER (PLUG IN TYPE) |
| RU-WH-006 | 1 AMP RECTIFIER AC TO DC CONVERSION |

SWITCHES AND BUTTONS



RU-906BH-MO-32D

- MOMENTARY
- Ideal for request-to-exit applications to release electromagnetic locks
- Fits (optional) standard single-gang surface or recessed electrical boxes
- 20-gauge stainless steel faceplate



RU-909S-MO-W

- MOMENTARY
- 909S surface mounted (shown)
- Ideal for desk mount applications
- Specify maintained or momentary action
- Smooth-action rocker with key symbol
- Beige housing



RU-950HP6-MO-32D

- MOMENTARY
- 950HP6 model features a large 6" diameter button designed for 4" x 4" x 1-1/2" switch boxes
- Stainless steel faceplate
- Tamper-resistant
- Ideal for vandal prone areas



RU-960-MO-28

- MOMENTARY
- Tamper-Resistant Keyswitches
- 3" x 4-3/4" Keyswitch
- Two #6-32 stainless steel tamper-proof spanner-head screws and wrench included
- Compatible with standard mortise cylinders with straight or clover cams in 1-1/8" cylinder length

RU-960DMA-DPDT-LED-28 MAINTAINED, LED DISPLAY

RU-C100-BEIGE SURFACE MOUNT BOX

- For mounting switches and keypads to a rigid surface

POWER TRANSFERS



RU-9507-12
12 INCH - FLEX LOOP

- Current Transfer Flex Loop
- Surface mounted on hinge side
 - Stainless steel cable
 - White plastic end caps
 - Accepts up to 4 conductor @ 22 ga. or 2 conductor @ 18 ga.
 - Length type - 23" (584.2mm)

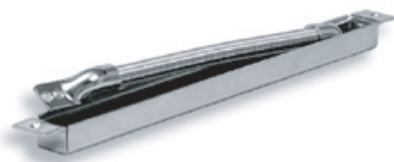

RU-9512-BRIGHT CHROME

- Mortise Bridge Cable Transfer 10-7/8" x 1"
- Full mortise
 - Stainless Steel
 - Inside diameter of cable 7/8"
 - Accepts up to 4 conductor @ 22 ga. or 2 conductor @ 18 ga.
 - 120-degree door swing
 - 5/8" depth
 - Bridge cables are recessed in the hinge side of the door/frame and concealed when door is closed for tamper-resistance.

CYLINDRICAL LOCKSETS

6 LINE KNOB (ORBIT) LOCKSETS

6 Line is a highly styled standard duty lock line. Built to conform to Federal Specification Series 160. It is ideally suited for fine homes, motels, apartment houses and small commercial buildings.

SA-6U15-OB-26D	PASSAGE
SA-6U65-OB-26D	PRIVACY
SA-6G04-OB-26D	STOREROOM
SA-6G05-OB-26D	ENTRANCE
SA-6G37-OB-26D	CLASSROOM



8 LINE KNOB (ORBIT) LOCKSETS

The Sargent Heavy duty knob locks, are an exceptionally high quality security product. They are certified under ANSI A 156.2 Series 4000 for Grade 1. The 8 Line affords great strength and security, quiet operation and long life.

SA-8U15-OB-26D	PASSAGE
SA-8G04-OB-26D	STOREROOM
SA-8G05-OB-26D	ENTRANCE
SA-8G37-OB-26D	CLASSROOM
SA-8U65-OB-26D	PRIVACY
SA-8G04-BC-26D	STOREROOM



10 LINE LEVER LOCKSETS

The Sargent Heavy duty 10 Line cylindrical lever lockset offer the convenience of cylindrical door preparation and ease of installation. Meeting ANSI 4000 grade 1 specifications, they are well suited for commercial installations.

SA-10U15-LL-26D	PASSAGE
SA-10G04-LL-26D	STOREROOM
SA-10G05-LL-26D	ENTRANCE
SA-10G37-LL-26D	CLASSROOM



T-ZONE LEVER LOCKSETS

No lever sag after 8 million cycles.

The SARGENT T-Zone sets a higher standard for Grade 1 bored-in locks.

The unique T-Zone construction provides unequalled strength and durability for the most demanding applications such as schools and hospitals. This is accomplished by true interlocking between the lockbody and the latch far exceeding the 156.2 Series 4000 Grade 1 standards like no other lock can.



SA-11U15-LL-26D	PASSAGE
SA-11G04-LL-26D	STOREROOM
SA-11G05-LL-26D	ENTRANCE
SA-11G37-LL-26D	CLASSROOM

MORTISE LOCKSETS

Sargent's 7200/8200 series mortise lockset offers the institutional end-user the finest locking product in the industry. With its 12 gauge lock body, the 7200/8200 Series mortise lock exceeds the requirements of the ANSI 1000 series grade 1 standards. Completely field reversible for both hand and bevel without opening the lock case, its patent pending features have set a new industry wide standard for mortise lockset quality and function.

7800 SERIES

7800 Mortise Knob Locks and 8200 Lever Locks are engineered with the following standard features:

- Easily re-handed without disassembling the lock body
- Stainless steel non-handed guardbolt
- Stainless steel 3/4" one-piece, anti-friction reversible latch bolt
- Stainless steel 1" throw deadbolt with hardened steel rollers
- 12 gauge heavy duty case and cap
- Inside front full 1/8" cold rolled steel
- Universal, non-handed curved lip strike
- Hubs and spring cartridge for long cycle life
- Lever and knob trim is thru-bolted for increased security and durability

SA-7815-OB-26D	PASSAGE
SA-7804-OB-26D	STOREROOM
SA-7805-OB-26D	ENTRANCE
SA-7805-MORTISE BODY	ENTRANCE
SA-7805-WTC-26D-LESS-CYL	ENTRANCE WITH ESCUTCHEON TRIM
SA-7837-MORTISE BODY	CLASSROOM
SA-7837-OB-26D	CLASSROOM
SA-7855-OB-26D	ENTRANCE WITH TOGGLE
SA-7855-WTC-26D-LESS-CYL	ENTRANCE WITH ESCUTCHEON TRIM



8200 SERIES

The Strongest Lock on the Block

When it comes to strength and durability, SARGENT continues to set standards with the 8200 Mortise lock. The 8200 far surpasses ANSI/BHMA A156.3 Series 1000 Grade 1 standards, making it the strongest and most durable mortise lock in the industry.

- Far Exceeds ANSI/BHMA A156.13 Series 1000 Grade 1 and Security Grade 1. Meets various higher security detention standards such as ASTM impact for latchbolt (Level 1) and deadbolt (Level 3) components
- Cycle Test - Exceeds 8 million cycles!
- No lever sag
- 1 piece hardened stainless steel deadbolt with 1" projection
- Stainless steel 3/4" projection one piece anti-friction reversible latch
- Through-bolted lever trim for increased security

•Torx® and spanner screws	
SA-8205-LNJ-26D	ENTRANCE
SA-8204-LNL-26D	STOREROOM
SA-8205-LNL-26D	ENTRANCE
SA-8243-WTJ-26D-LESS-CYL	ENTRANCE
SA-8225-LNJ-26D-LESS-CYL	DORMITORY
SA-8215-LNJ-26D	PASSAGE
SA-8225-WTJ-26D-LESS-CYL	DORMITORY
SA-8204-WTJ-26D-LESS-CYL	STOREROOM
SA-8204-LNJ-26D-LESS-CYL	STOREROOM



LNL



WT



DEADBOLTS

For Doors 1 3/8" and standard. Furnished regular for 1 3/4" - thick doors. 2 3/4" Backset only. Brass Bolt 1" throw with hardened steel rollers standard



- For Doors 1 3/4 in (44 mm) standard.
- 2-3/4" backset only
- Strike: 480, 3-1/2" x 1-1/8" with strike box
- Non-handed, completely reversible
- Thumb-turn: No. 130W furnished standard
- UL/cUL Listed: Listed for use on fire doors



SA-485-26D-LA SINGLE CYLINDER, SATIN CHROME
SA-484-26D-LA DOUBLE CYLINDER, SATIN CHROME

SA-4875-26D LESS CYLINDER, SINGLE CYLINDER
SA-4874-26D LESS CYLINDER, DOUBLE CYLINDER

CYLINDERS

1-1/8" MORTISE CYLINDER, SATIN CHROME FINISH

Brass Cylinder, Furnished standard with No. 97 Compression Ring.

AVAILABLE KEYWAYS

SA-41-26D- LA, LB, LC, RE, RG, RK, RL AND RJ



KEY-IN-KNOB CYLINDERS

Brass cylinder for use with sargent locksets only, Satin nickle finish

AVAILABLE KEYWAYS

SA-13-3130-C15- LA, LB, LF, RS

SA-13-3266-C15- LA



6 LINE (B KNOB)
7,10 LINE LEVERS

RIM CYLINDERS

For use with SARGENT Exit Devices. Brass Cylinder furnished standard with No. 99 Cylinder Ring, "break-off" screws and back plate and Satin chrome finish.

AVAILABLE KEYWAYS

SA-34-26D- LA, LB, LC, RC AND RJ

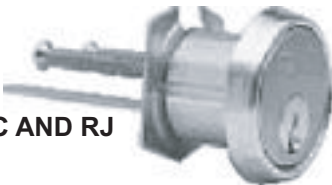

1/C CORE CYLINDERS

SARGENT removable core cylinders can be used with SARGENT mortise locks, cylindrical locks

SA-6300-C15-HA-KEYED
KEYED WITH 2 KEYS. HA KEYWAY

SA-6300-C15-LA-SUBASSY
SUB-ASSEMBLED, LA KEYWAY

SA-6034-26D RIM CYLINDER HOUSING 5 & 6 PIN
SA-6042-26D MORTISE CYLINDER HOUSING 6 PIN



PADLOCKS



- Shackle Height - 2" Clearance and 5/16" diameter
- Shackle Material - Hardened steel
- Cylinder - Utilizes standard 10 Line with padlock tail piece, keyed different as standard
- Case Finish - Brass only. Solid one piece construction
- Keys - Two keys provided as standard

SA-758HS-2 PADLOCK, 2" SHACKLE

ORIGINAL BRASS KEY BLANKS

5 PIN KEY BLANKS
(SOLD IN MULTIPLES OF 50)

SA-KBB278CA
SA-KBB275LA
SA-KBB275LB
SA-KBB275LC

6 PIN KEY-BLANKS
(SOLD IN MULTIPLES OF 50)

SA-KBB6275LA
SA-KBB6275LB
SA-KBB6275LC
SA-KBB6275LE
SA-KBB6275LG
SA-KBB6275RK

DOOR CLOSERS

351 POWERGLIDE SERIES

The 351 Series Powerglide Door Closer has been engineered to meet the demands of the modern architect and building owner. Offering versatility and built-in power. The 351 Series Door closer has the quality of flexibility.. so important to today's architectural concepts where doors are subject to highly sophisticated climatic control conditions and a variety of traffic patterns.

FEATURES

- GRADE 1
- CAST ALUMINUM
- ALL WEATHER FLUID
- SIZE 1-6
- PARALLEL ARM BRACKET INCLUDED
- LATCHING SPEED VALVE
- DELAYED ACTION VALVE
- CLOSING SPEED VALVE
- BACKCHECK VALVE



SA-351-UO-EN
SPRAYED ALUMINUM FINISH

SA-351-H-EN-HOLD OPEN
SPRAYED ALUMINUM FINISH
WITH HOLD-OPEN ARM



281 POWERGLIDE SERIES

The 281 door closer are designed to meet the requirement of the disabled, defining lbs. of opening force for interior and 8 lbs. for exterior. The spring design allows adjustment for more closing force when needed such as where there is excessive draft or pressure conditions.

FEATURES

- GRADE 1
- CAST IRON
- VERSATILE MOUNTING BRACKET
- ALL WEATHER FLUID
- SIZE 1-6
- PARALLEL ARM BRACKET INCLUDED
- LATCHING SPEED VALVE
- DELAYED ACTION VALVE
- CLOSING SPEED VALVE
- BACKCHECK VALVE

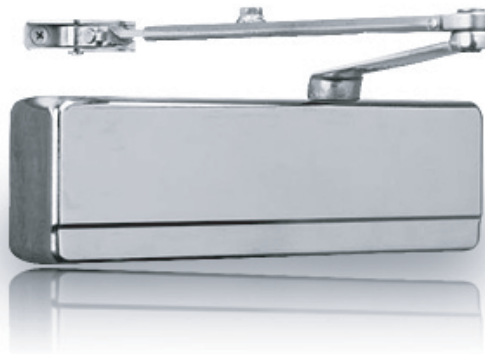

SA-281-UO-EN
SPRAYED ALUMINUM FINISH

SA-281-UH-EN
SPRAYED ALUMINUM FINISH
WITH HOLD-OPEN ARM



EXIT DEVICES

38 SERIES

Chassis mounted unit construction assures easy installation and maintenance. Tapered push rail and angled covers. Steel endcaps and covers. UL Listed. UL Listed to Canadian safety standards

- SA-3828F-EN ALUMINUM FINISH
- SA-12-3828F-EN FIRE RATED, ALUMINUM FINISH
- SA-68-2596 DOGGING KIT FOR 3828

3828 TRIMS

- SA-28-C-LL-26D CLASSROOM
- SA-28-C-OB-26D CLASSROOM
- SA-28-C-TP-PEN CLASSROOM
- SA-28-K-OB-26D STOREROOM
- SA-28-L-OB-26D PASSAGE
- SA-28-K-HTB-PEN STOREROOM
- SA-28-K-TP-PEN STOREROOM
- SA-28-L-TP-PEN PASSAGE
- SA-28-K-LL-26D STOREROOM

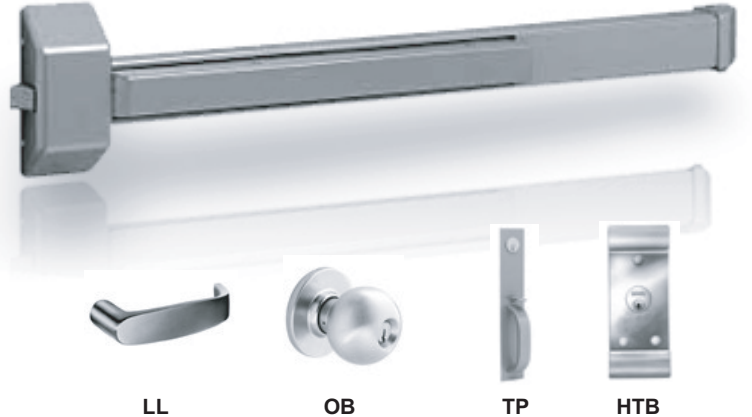

88 SERIES

High impact resistant Lexan touchpad on rail assembly. Rail assemblies and end caps are Stainless Steel. Stainless steel springs throughout. Chassis mounted unit construction for easy installation and service. Simple lever principle with push type action. Rail travels in direction of door swing. Trim is thru bolted. All exit devices meet ANSI standard 156.3, Grade 1. All exit devices are UL Listed. UL Listed to Canadian safety standards.

RIM PANIC DEVICE

- SA-8888F-EN ALUMINUM FINISH
- SA-12-8888F-32D FIRE RATED, STAINLESS STEEL
- SA-16-8810F-32D CYLINDER DOGGING, LESS CYL.
- SA-8888F-32D STAINLESS STEEL

RIM PANIC DEVICE WITH LOCKABLE THUMBPIECE TRIM

- SA-8863F-32D-LHR STAINLESS STEEL
- SA-8863F-32D-RHR STAINLESS STEEL
- SA-816-A-32D CYLINDER DOGGING KIT



- SA-98-K-PTB-32D STOREROOM
- SA-713-8-ETL-26D CLASSROOM
- SA-98-T-PTB-32D CLASSROOM
- SA-715-8-ETL-26D PASSAGE

98 SERIES

For wood or metal doors. 1 3/4 in. (44.5mm) thick standard. 4 1/8 in. (105mm) minimum stile. Mounting supplied standard with wood and machine screws. Stainless steel chassis cover. Nonferrous alloy chassis. Crossbar: 1 in stainless steel tubing. Available on order with steel reinforcement. Standard alien key dogging. 641 Strike. Fire exit hardware not available



SA-9898-32D STAINLESS STEEL

- SA-98-T-PTB-32D THUMBPIECE TRIM
- SA-97-0001 DOGGING ALLEN KEY
- SA-97-0012 ARM SPRING
- SA-98-2159 LATCHBOLT SPRING & BRACKET



PTB

SARGENT AND GREENLEAF®

6120 Series Motorized Electronic Safe Lock

- Underwriters Laboratories Listed Type 1.
- A motor-driven lock bolt offers a high level of security by eliminating the threat of vibration and bouncing attacks.
- Management reset code, one master code, and eight user codes.
- Management reset code (MRC) restores the lock to its original factory code if the master code is lost.
- Time delay up to 9 minutes.
- The 6120 Series incorporates a penalty time feature to prevent opening by entering sequential or random codes until a valid code is found.
- All programming is quickly and easily done via the keypad (no separate programming equipment required).
- The deadlocking square bolt model withstands 225 lbs. (1000 newtons) of bolt end pressure for a high level of security and durability in boltwork blocking applications.
- Non-deadlocking spring bolt model is designed for lightweight and inner compartment doors that require the lock to latch and secure the door.
- Can be used with the Biometric Keypad, 2-battery keypad, standard 1-battery keypad, and the non-rotating low profile keypad.



SG-6120-305

S&G ELECTRONIC KEYPAD (SATIN CHROME)



EVEREST PRIMUS

Everest Primus—the Ultimate Security Solution

Business owners are becoming increasingly aware of the importance of key control in building security. Heightened security awareness is driving a strong demand for patented key systems backed with professional security support. Schlage is pairing our highest security key system, Everest Primus, with select security dealers to provide the ultimate security solution.

FEATURES

- Patent protected key control distribution through 2014
- Keys into Everest Open or Everest Restricted key systems
- Thick Nickel Silver Keys
- Large Key Bows
- Standard Pins
- Everest Keyway Designs

BENEFITS

- Controlled key issuance and duplication
- Provides economical security solutions and upgrades
- Strong, durable keys
- More space for stamping
- Standard key machine can be used
- Pinning is simple
- Keys can be bitted quickly using existing key cutting equipment

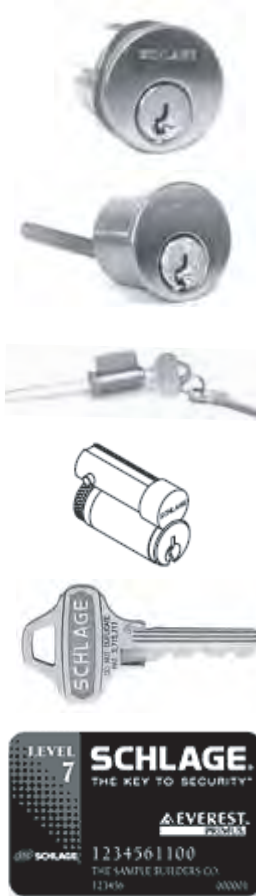
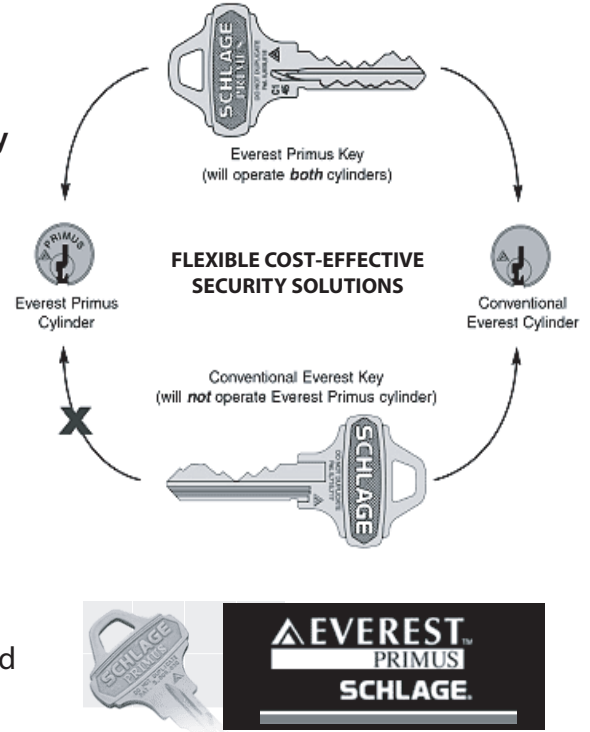

PE-20700-114-626-C123-LKB

1-1/4" MORTISE CYLINDER, STD.CAM

PE-20700-118-626-C123-LKB

1-1/8" MORTISE CYLINDER, STD.CAM

PE-20706-118-626-C123-LKB

1-1/8" MORTISE CYLINDER, ADAMS-RITE CAM

PE-20710-626-C123-LKB

RIM CYLINDER

PE-20724-122-626-C123-LKB

A SERIES CYLINDER FOR ORBIT KNOB

PE-20729-626-C123-LKB

B SERIES CYLINDER FOR B SERIES DEADBOLTS

PE-20740-626-C123-LKB

I/C (INTERCHANGEABLE CORE) CYLINDER

PE-35004-C123-1605

6 PIN KEYBLANKS (LEVEL 7)

PE-35005-C123-1605

I/C CORE CONTROL KEYBLANKS

PE-40065-C123

REGISTRATION CARDS FOR LEVEL 7

EVEREST PRIMUS



PE-B560P-605-C123-LKB
PE-B560P-626-C123-LKB

GRADE 2 SINGLE CYLINDER DEADBOLT
GRADE 2 SINGLE CYLINDER DEADBOLT



PE-B760P-605-C123-LKB
PE-B760P-626-C123-LKB

GRADE 1 SINGLE CYLINDER DEADBOLT
GRADE 1 SINGLE CYLINDER DEADBOLT



PE-B762P-605-C123-LKB
PE-B762P-626-C123-LKB

GRADE 1 DOUBLE CYLINDER DEADBOLT
GRADE 1 DOUBLE CYLINDER DEADBOLT

EVEREST

Patent Protected The Everest product line is covered by new utility patents to prevent manufacturing and distribution of aftermarket key blanks by anyone other than Schlage.



MORTISE CYLINDERS

SE-20-001-114-626-C123**0"BIT, ADAMS-RITE STANDARD CAM

SE-20-001-118-626-C123**0"BIT, STANDARD CAM

SE-20-013-118-626-C123**0"BIT, A/R CAM



RIM CYLINDER "0" BITTED

SE-20-021-626-C123

SE-21-002-122-626-C123 "A" SERIES CYLINDER, "0" BITTED

SE-23-001-626-C123* **"D" SERIES KNOB CYLINDER, "0" BITTED

SE-23-013-626-C123* **"D" SERIES LEVER CYLINDER, "0" BITTED

SE-22-644-626-C123** B600 SERIES CYLINDER, "0" BITTED

SE-22-645-626-C123** B662 SERIES CYLINDER, "0" BITTED

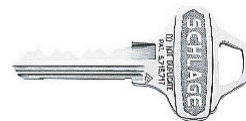
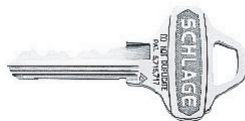
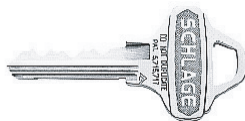
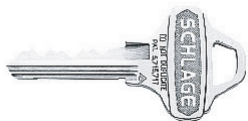
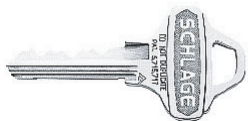

KEYBLANKS

Strong Keys, the new nickel silver key is 15% thicker to resist breakage, and the key bow is 25% larger for easier handling and customer marking.

SE-35-009-C123

SOLD IN MULTIPLES OF 50

SE-35-009-C145

SOLD IN MULTIPLES OF 50

SE-35-009-C234

SOLD IN MULTIPLES OF 50

SCHLAGE PRIMUS

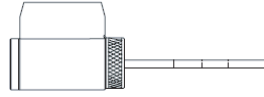
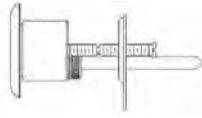

PP (1302) LEVEL 1+

MORTISE CYLINDERS

PP-20700-114-626CP-1302	1-1/4", STANDARD CAM
PP-20700-118-626CP-1302	1-1/8", STANDARD CAM
PP-20706-118-626CP-1302	1-1/8", A.R. CAM

RIM CYLINDERS

PP-20710-613CP-LKB-1302	OIL RUBBED BRONZE
PP-20710-626CP-LKB-1302	SATIN CHROME

KEY-IN-KNOB CYLINDERS

PP-20720-626CP-LKB-1302	SARGENT 7-8 LINE
PP-20724-122-626CP-1302	FOR A SERIES KNOB
PP-20726-626CP-LKB-1302	SARGENT 6 LINE
PP-20729-606CP-LKB-1302	FOR B SERIES BC552 & BC762
PP-20748-626CP-LKB-1302	FOR D SERIES KNOB

B SERIES DEADBOLT CYLINDERS

PP-20729-626CP-LKB-1302	FOR DOUBLE DEADBOLT
-------------------------	---------------------

LARGE FORMAT I/C CORE

PP-20740-626CP-LKB-1302	I/C CORE CYLINDER
-------------------------	-------------------

KEY BLANKS AND REGISTRATION CARDS

PP-35052CP-1302	I/C CONTROL KEYBLANK
PP-35053CP-1302	6 PIN KEYBLANK LEVEL 1+ (MULTIPLES OF 50)
PP-40065-1302	REGISTRY CARD

DEADBOLTS

PP-B760P-605CP-LKB-1302	SINGLE CYLINDER
PP-B760P-626CP-LKB-1302	SINGLE CYLINDER
PP-B762P-605CP-LKB-1302	DOUBLE CYLINDER
PP-B762P-626CP-LKB-1302	DOUBLE CYLINDER

PC (1026) LEVEL 1

MORTISE CYLINDERS

PC-20700-118-626CP-1026	YALE CAM
PC-20706-118-626CP-1026	A.R.CAM

RIM CYLINDERS

PC-20710-626CP-1026	RIM CYLINDER
---------------------	--------------

A SERIES CYLINDERS

PC-20724-122-626CP-1026	FOR ORBIT KNOB
-------------------------	----------------

KEY BLANKS (MULTIPLES OF 50)

PC-35157CP-1026	6 PIN KEYBLANK
-----------------	----------------

DEADBOLTS

PC-B760P-605CP-1026	SINGLE CYLINDER
PC-B760P-626CP-1026	SINGLE CYLINDER
PC-B762P-605CP-1026	DOUBLE CYLINDER
PC-B762P-626CP-1026	DOUBLE CYLINDER

PR (1081) LEVEL 1+

MORTISE CYLINDERS

PR-20700-114-626CP-1081	1-1/4", STANDARD CAM
PR-20700-118-605CP-1081	1-1/8", STANDARD CAM
PR-20700-118-626CP-1081	1-1/8", STANDARD CAM
PR-20706-118-626CP-1081	1-1/8", A.R. CAM

RIM CYLINDERS

PR-20710-626CP-LKB-1081	RIM CYLINDER
-------------------------	--------------

KEY-IN-KNOB CYLINDERS

PR-20720-626CP-LKB-1081	FOR SARGENT 7-8 LINE
PR-20724-122-626CP-1081	FOR A SERIES ORBIT KNOB
PR-20726-626CP-LKB-1081	FOR SARGENT 6 LINE
PR-20748-626CP-LKB-1081	FOR D SERIES KNOB

B SERIES DEADBOLT CYLINDERS

PR-20729-626CP-LKB-1081	FOR DOUBLE DEADBOLT
PR-20744-626CP-LKB-1081	B700, B800 SERIES

LARGE FORMAT I/C CORE

PR-20740-626CP-LKB-1081	I/C CORE CYLINDER
-------------------------	-------------------

KEY BLANKS AND REGISTRATION CARDS

PR-35052CP-1081	I/C CONTROL KEYBLANK
PR-35053CP-1081	6 PIN KEYBLANK LEVEL 1+ (MULTIPLES OF 50)
PR-40065-1081	REGISTRY CARD

DEADBOLTS

PR-B760P-605CP-LKB-1081	SINGLE CYLINDER
PR-B760P-626CP-LKB-1081	SINGLE CYLINDER
PR-B762P-605CP-LKB-1081	DOUBLE CYLINDER
PR-B762P-626CP-LKB-1081	DOUBLE CYLINDER

PADLOCKS

PR-PL1741-CP-LKB-1081	1-1/8" SHACKLE
PR-PL1743-CP-LKB-1081	3" SHACKLE

PRIMUS PARTS

PR-34-002	#2 FINGER PIN (SOLD IN MULTIPLES OF 100)
PR-34-004	#4 FINGER PIN (SOLD IN MULTIPLES OF 100)
PR-34-006	#6 FINGER PIN (SOLD IN MULTIPLES OF 100)
PR-40-066	CYLINDER PLUG HOLDER
PR-B502-944	ADAMS RITE CAM ONLY FOR MS SERIES
PR-B502-948	STANDARD CAM ONLY (STRAIGHT CAM)
PR-B502-949	B SERIES DRIVER FOR BC160P
PR-B520309	CAM FOR CORBIN-RUSSWIN #11
PR-B520329	CAM FOR YALE (2160 CYL.) OR SARGENT CAM
PR-B610-084	B700, B800 SERIES DRIVER & RETAINER
PR-L583-153	L SERIES CAM ONLY
PR-N523-022	ND SERIES TAILPIECE

9000 SERIES NARROW STYLE



The KC9000 model offers multiple options and models for a variety of aluminum door latches and deadbolts. These locks also feature a 12-button keypad, iButton credential reader, and a Schlage cylinder.

Features Benefits

- Easy-to-Install** - Battery Powered means no wiring or power supplies. Provides up to 40,000 cycles or 3 years of power.
- Flexible** - A selection of levers, knobs and finishes provide a wide variety of options to match most existing hardware
- Tough** - Weather resistant design and Vandlgard™ clutching lever feature means it keeps working no matter what it runs into
- Smart** - A variety of programming modes allow for special code functions such as a 1 time use, toggle mode or lockout
- Upgradeable** - can be upgraded to Everest / Primus high security on select doors without a complete rekey.

iBUTTON ON
KEYFOB



SC-IBF

SC-KC9111-626-LC
SC-KC9232-626-LC

SCHLAGE KING COBRA NARROW STILE LOCK (LESS CYL.)
SCHLAGE KING COBRA NARROW STILE LOCK (LESS CYL.)

5000 SERIES CYLINDRICAL LOCKSET

iBUTTON ON
KEYFOB



SC-IBF



- 2-3 year battery life with standard AA alkaline batteries (provided) over 80,000 cycles
- Adjustable door thickness - 1½" - 2" with no extra parts required
- Cover plate options-Masks door preps from other manufacturers' preps
- 100-code capacity, programmable at keypad
- 17 Style Lever
- Accepts SFIC cylinder, dummy plug provided
- Backset: 2¾" (70mm) only.
- 2¾" backset with ½" latchbolt
- High-security spanner screws on inside escutcheon,
- No exposed screws on exterior
- Classroom/storeroom function

ALSO AVAILABLE...



MG-5196-32D

SC-KC5196-17-626-LH-LC

SATIN CHROME / LEFT HAND

SC-KC5196-17-626-RH-LC

SATIN CHROME / RIGHT HAND

KING COBRA 2 CYLINDRICAL LOCKS WITH SNAP PROGRAMMING

KC5000-2 Locks are designed for cylindrical and mortise door preps and can be used in any facility, and any door where electronic access control is desired to simplify key control and increase the level of security. A perfect solution for hospitals, education, multi-family, airports and government, property management and more. A great security, convenience and performance upgrade from a reliance on mechanical keys or mechanical pushbutton locks.

- SNAP programmability
- 1000 individual user codes and credentials
- 1000 audit trail events
- Enhanced environmental durability
- Upward migration with Security Management System Express software from Schlage and features
- Time Zones when managed using Express software



PROGRAMMER NOT INCLUDED

SC-KC5196-2-17-626-LH-LC SCHLAGE KING COBRA 2 WITH SNAP LOCK(LESS CYLINDER)
SC-KC5196-2-17-626-RH-LC SCHLAGE KING COBRA 2 WITH SNAP LOCK(LESS CYLINDER)

PROGRAMMER & PC APPLICATION FOR KING COBRA 2 LOCKS

Easy offline access control management

The SNAP Programmer and PC Application provides an easy way to link people, doors and locks for simple access control management. SNAP was designed for the busy user, for use with all Schlage KC2 locks. Simplicity, speed, ease of use, an intuitive layout; these were all key drivers in developing a solution that takes programming and managing locks to a whole new level – a lower, simpler one. The end result is a handheld programming tool that is so simple, you won't need extensive training, and you won't forget how it works the next time you pick it up.

The SNAP Programmer communicates with your PC via the USB port – acting much like a jump drive or external USB storage device. A simple screen and keypad layout provides easy navigation. The built-in iButton reader allows for quick registration of iButton credentials, allowing you to move beyond simple numeric pin codes for building security and access control.

The SNAP PC Application runs on your PC and is where you connect people and doors. The screen interface provides a simple, intuitive layout, drag and drop features and data import/export hot buttons, making setting up and managing the access control in your facility a snap. The installation is non-invasive and will not conflict with other programs already running on your PC.



SC-SNAP



RESIDENTIAL ELECTRONIC KEYPAD ENTRY LOCKS

Schlage Keypad Deadbolts bring professional grade security with the convenience of keyless access to the home. The innovative Turn-Lock feature allows the user to lock and leave without a key. Ideal for front, back and side entry doors where deadbolts are required.

Features:

- Grade 2 ANSI/BHMA certified
- Commercial grade clutching motor drive (tested to one million cycles)
- Vandal resistant free-spinning deadbolt turn
- Code Control, easily programmed at the keypad (19 user code capacity, with 10,000 possible user code combinations)
- Warning sounds after 4 incorrect codes entered (Keypad disabled for 30 seconds)
- Keypad illuminates when touched
- Fits most standard door preps (Fits doors 1 3/8" to 1 3/4" thick)
- Adjustable 2-3/4" to 2-3/8" backset
- One tool installation on pre-prepped doors
- 9 volt battery included with average 3 year battery life (no special wiring required)



SC-FE595-PLY-FLAIR-619
Satin Nickel Lockset



SC-BE365-PLY-619
Satin Nickel Deadbolt

SC-BE365-PLY-505
Lifetime Brass Deadbolt

L-SERIES MORTISE LOCKSETS

The Schlage L-Series mortise locks are equipped with conventional cylinders and sectional trim, the L-Series extra heavy duty mortise lock provides ANSI 156.13, Grade 2 security to enhance its existing Grade 1 operational requirements for mortise locks with sectional and escutcheon trim. The series continues to exceed Grade 1 security requirements with concealed cylinders.

It is UL Listed and can be specified for applications in offices, schools, hospitals, hotels, commercial/industrial buildings as well as residences.



SC-L9010-03B-626

SC-L9040-03B-626

SC-L9050L-03B-626

SC-L9070L-03B-626

SC-L9080L-03B-626

SC-L9453L-03B-626

SC-L9453L-06B-626

SC-L9456L-03B-626

SC-L9486P-06B-626-L583375

PASSAGE MORTISE LOCKSET, SATIN CHROME

PRIVACY MORTISE LOCKSET, SATIN CHROME

OFFICE LOCKSET, LESS CYLINDER, SATIN CHROME

CLASSROOM LOCKSET, LESS CYLINDER, SATIN CHROME

STOREROOM SET, LESS CYLINDER, SATIN CHROME

ENTRANCE LOCKSET WITH DEADBOLT, LESS CYLINDER, SATIN CHROME

ENTRANCE LOCKSET WITH DEADBOLT, LESS CYLINDER, SATIN CHROME

ENTRANCE LOCKSET WITH DEADBOLT, LESS CYLINDER, SATIN CHROME

HOTEL MORTISE LOCKSET, WITH OCCUPIED INDICATOR, SATIN CHROME



GRADE 3 RESIDENTIAL KNOB AND LEVER LOCKSETS

When you install Schlage knobs and levers, you safeguard your home and family as well as your peace of mind. Our knobs will never tarnish, discolor, or corrode, and will always perform to your expectations. Our wide variety of styles and finishes may make your decision tough.



ORBIT DESIGN



ELAN DESIGN

FEATURES

- Adjusts to fit all standard door preparations
- Easy installation- One-person project; no extra hands needed
- Quality materials and construction for exceptional security

SC-F10N-ORB-626	PASSAGE SET, SATIN CHROME, ORBIT DESIGN
SC-F10N-ORB-605	PASSAGE SET, POLISHED BRASS, ORBIT DESIGN
SC-F10N-ORB-605-5-INCH	PASSAGE SET, LIFETIME-POLISHED BRASS, ORBIT DESIGN, 5" BACKSET
SC-F10N-ORB-609	PASSAGE SET, ANTIQUE BRASS, ORBIT DESIGN
SC-F30N-ORB-605	BALCONY LOCKSET, POLISHED BRASS, ORBIT DESIGN
SC-F40N-ORB-626	PRIVACY LOCKSET, SATIN CHROME, ORBIT DESIGN
SC-F40N-ORB-605	PRIVACY LOCKSET, POLISHED BRASS, ORBIT DESIGN
SC-F40N-ORB-609	PRIVACY LOCKSET, ANTIQUE BRASS, ORBIT DESIGN
SC-F51N-ORB-626	ENTRANCE LOCKSET, SATIN CHROME, ORBIT DESIGN
SC-F51N-ORB-505/605	ENTRANCE LOCKSET, LIFETIME-POLISHED BRASS, ORBIT DESIGN
SC-F51N-ORB-505/605-5"	ENTRANCE LOCKSET, LIFETIME-POLISHED BRASS, ORBIT DESIGN, 5" BACKSET
SC-F51N-ORB-626	ENTRANCE LOCKSET, SATIN CHROME, ORBIT DESIGN
SC-F51N-ORB-609	ENTRANCE LOCKSET, ANTIQUE BRASS, ORBIT DESIGN
SC-F10N-ELA-626	PASSAGE SET, SATIN CHROME, ELAN LEVER DESIGN
SC-F10N-ELA-605	PASSAGE SET, POLISHED BRASS, ELAN LEVER DESIGN
SC-F10N-ELA-609	PASSAGE SET, ANITQUE BRASS, ELAN LEVER DESIGN
SC-F40N-ELA-626	PRIVACY LOCKSET, SATIN CHROME, ELAN LEVER DESIGN
SC-F40N-ELA-605	PRIVACY LOCKSET, POLISHED BRASS, ELAN LEVER DESIGN
SC-16-126-605	DEADLATCH, 5" BACKSET
SC-16-207-605	DEADLATCH, 2-3/8" - 2-3/4" BACKSET
SC-16-210-605V	SPRINGLATCH, 2-3/8" - 2-3/4" BACKSET

GRADE 1 INDUSTRIAL B-SERIES DEADBOLTS

The **B600-Series** are Schlage's highest grade deadbolt locks, featuring solid brass or bronze 7/8" (22 mm) rotating trim rings. Bolts are made of a strong alloy, containing a hardened steel roller to prevent cutting or sawing. Mounting screws are protected against drilling by steel balls.

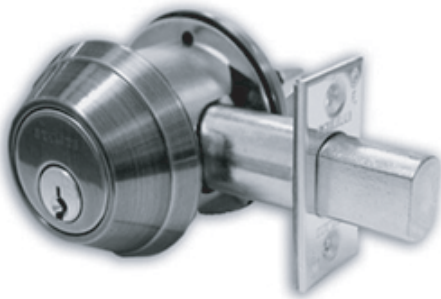

SINGLE CYLINDER DEADBOLTS

SC-B660JD-626	I/C CORE, LESS CYLINDER
SC-B660L-626	LESS CYLINDER
SC-B660P-605	POLISHED BRASS, C KEYWAY
SC-B660P-626	SATIN CHROME, C KEYWAY

DOUBLE CYLINDER DEADBOLTS

SC-B662P-605	BRASS, C KEYWAY
SC-B662P-626	SATIN CHROME, C KEYWAY

CLASSROOM FUNCTION DEADBOLT

SC-B663P-626	SINGLE CYLINDER OUTSIDE, CLASSROOM TURN INSIDE
--------------	--



B-SERIES DEADBOLT PARTS

SC-B610-044	TAILPIECE PACK FOR B600/B663
SC-12-100-626	DEADLATCH ONLY FOR B250, SATIN CHROME (2-3/8 BACKSET)
SC-12-103-626	DEADLATCH ONLY FOR B250, SATIN CHROME (2-3/4 BACKSET)
SC-12-630-605	2-3/8" BOLT ONLY FOR B600/700/800, POLISHED BRASS
SC-12-630-626	2-3/8" BOLT ONLY FOR B600/700/800 DEADBOLT, SATIN CHROME
SC-12-631-626	2-3/4" BOLT ONLY FOR B600/700/800 DEADBOLT, SATIN CHROME

GRADE 2 B-SERIES DEADBOLTS

The B500-Series deadbolt offers a 10% larger deadbolt diameter, a new adjustable lock-in-place backset for 2 3/8" (60 mm) or 2 3/4" (70 mm) door preps, and an integrated anti-pry shield to prevent picking. The 1" (25 mm) reinforced trim ring and tapered housing rotate to protect against wrenching the cylinder. The solid brass 6-pin cylinder offers added protection and durability. A metal dust box reinforcer with three 3" screws provides deeper anchoring to protect against kick-in attacks.

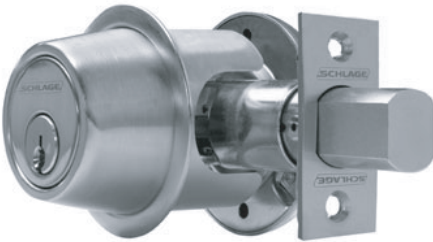

SINGLE CYLINDER DEADBOLTS

SC-B560P-605-C	POLISHED BRASS, C KEYWAY
SC-B560P-609-C	ANTIQUE BRASS, C KEYWAY
SC-B560P-626-C	SATIN CHROME, C KEYWAY
SC-B560P-626-E	SATIN CHROME, E KEYWAY
SC-B560PF-626-C-FIRE	FIRE RATED - SATIN CHROME, C KEYWAY
SC-B560PF-626-E-FIRE	FIRE RATED - SATIN CHROME, E KEYWAY



DOUBLE CYLINDER DEADBOLTS

SC-B562P-605-C	POLISHED BRASS, C KEYWAY
SC-B562P-626-C	SATIN CHROME, C KEYWAY

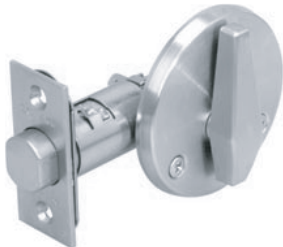

SINGLE SIDED THUMBTURN, NO CYLINDER

SC-B580-626	SATIN CHROME
SC-B580-605	POLISHED BRASS

INDICATOR DEADBOLT IN SATIN FINISH

SC-B871-626	OCCUPIED/VACANT DISPLAY
-------------	-------------------------



FALCON I/C CORE DEADBOLT

SC-D841BD-626-FIC-6PIN	FALCON 6/7 pin I/C CORE DEADBOLT
------------------------	----------------------------------

The B250-Series nightlatch features a 9/16" (14 mm) deadlatch that prevents "shimming" the bolt with a credit card or similar tool. A "hold-back" feature retains the deadlatch in a retracted position when desired. Trim rings are reinforced with hardened steel inserts. Brass or bronze faceplates are self-adjusting for beveled door edges.

NIGHT LATCH DEADBOLTS



SC-B250PD6-605	SINGLE CYLINDER DEADLATCH, 2-3/4 BACKSET, POLISHED BRASS
SC-B250PD6-626	SINGLE CYLINDER DEADLATCH, 2-3/4 BACKSET, SATIN CHROME
SC-B252PD-626	DOUBLE CYLINDER DEADLATCH, 2-3/4 BACKSET, SATIN CHROME
SC-12-100-626	REPLACEMENT DEADLATCH ONLY FOR B250 (2-3/8 BACKSET)
SC-12-103-626	REPLACEMENT DEADLATCH ONLY FOR B250 (2-3/4 BACKSET)

GRADE 1 KNOB CYLINDRICAL LOCKSETS

When the highest quality mechanisms are required, commercial quality D-Series locks are your best choice. Precision manufactured to exact tolerances, this top-of-the-line series is best suited for commercial, institutional and industrial use. You can choose from a broad range of knob designs, in a dozen standard finishes.

**ORBIT DESIGN****PLYMOUTH DESIGN**

SC-D10S-ORB-626	PASSAGE SET, SATIN CHROME, ORBIT DESIGN
SC-D40S-ORB-626	PRIVACY LOCKSET, SATIN CHROME, ORBIT DESIGN
SC-D53LD-ORB-626	ENTRANCE LOCKSET, SATIN CHROME, LESS CYLINDER, ORBIT DESIGN
SC-D53PD-ORB-626	ENTRANCE LOCKSET, SATIN CHROME, ORBIT DESIGN
SC-D70LD-ORB-626	CLASSROOM LOCKSET, LESS CYLINDER, SATIN CHROME, ORBIT DESIGN
SC-D70PD-ORB-626	CLASSROOM LOCKSET, SATIN CHROME, ORBIT DESIGN
SC-D70PD-PLY-630	CLASSROOM LOCKSET, SATIN CHROME, PLYMOUTH DESIGN
SC-D80LD-ORB-626	STOREROOM LOCKSET, SATIN CHROME, ORBIT DESIGN
SC-D80PD-ORB-626	STOREROOM LOCKSET, SATIN CHROME, ORBIT DESIGN
SC-D80PD-PLY-630	STOREROOM LOCKSET, SATIN CHROME, PLYMOUTH DESIGN
SC-D82PD-ORB-626	DOUBLE STOREROOM LOCKSET, SATIN CHROME, ORBIT DESIGN

GRADE 1 LEVER CYLINDRICAL LOCKSETS

SC-ND10S-RHO-626	PASSAGE SET, RHODES LEVER, SATIN CHROME
SC-ND170-RHO-626	DUMMY LEVER, RHODES LEVER, SATIN CHROME
SC-ND40S-RHO-626	PRIVACY, RHODES LOCKSET, SATIN CHROME
SC-ND53LD-RHO-626	ENTRANCE LOCKSET, RHODES LEVER, LESS CYLINDER
SC-ND53PD-RHO-626	ENTRANCE LOCKSET, RHODES LEVER, C KEYWAY
SC-ND70LD-RHO-626	CLASSROOM LOCKSET, RHODES LEVER, LESS CYLINDER
SC-ND70PD-RHO-626	CLASSROOM LOCKSET, RHODES LEVER, C KEYWAY
SC-ND80LD-RHO-626	STOREROOM LOCKSET, RHODES LEVER, LESS CYLINDER
SC-ND80PD-RHO-626	STOREROOM SET, RHODES LEVER, C KEYWAY
SC-ND92LD-RHO-626	ENTRANCE VANDL GUARD CLUTCH LOCKSET, RHODES LEVER, SATIN CHROME



GRADE 2 CYLINDRICAL KNOB AND LEVER LOCKSETS

Since its invention in 1925, the A-Series continues to be the cornerstone of Schlage's product line and sets standards by which the industry is bound. Worldwide acceptance and use of the A-Series are testimony to the precision and integrity of its design. A-Series locksets are constructed of high strength steel and plated for superior corrosion resistance and maintenance-free performance. A variety of knob and lever designs are offered in several finishes and functions to meet quality residential or commercial needs.



ORBIT DESIGN



TULIP DESIGN



SATURN DESIGN



JUPITER DESIGN

SC-A10S-ORB-626	PASSAGE SET, SATIN CHROME, ORBIT DESIGN
SC-A10S-ORB-605	PASSAGE SET, POLISHED BRASS, ORBIT DESIGN
SC-A40S-ORB-626	PRIVACY LOCKSET, SATIN CHROME, ORBIT DESIGN
SC-A40S-ORB-605	PRIVACY LOCKSET, POLISHED BRASS, ORBIT DESIGN
SC-A40S-TUL-626	PRIVACY LOCKSET, SATIN CHROME, TULIP DESIGN
SC-A40S-TUL-605	PRIVACY LOCKSET, POLISHED BRASS, TULIP DESIGN
SC-A53LD-ORB-626	ENTRANCE LOCKSET, SATIN CHROME, LESS CYLINDER, ORBIT DESIGN
SC-A53PD-ORB-605	ENTRANCE LOCKSET, POLISHED BRASS, ORBIT DESIGN
SC-A53PD-ORB-626	ENTRANCE LOCKSET, SATIN CHROME, ORBIT DESIGN
SC-A53PD-ORB-613	ENTRANCE LOCKSET, OIL RUBBED BRONZE
SC-A53PD-ORB-626-238	ENTRANCE LOCKSET, SATIN CHROME, ORBIT DESIGN, 2-3/8" BACKSET
SC-A53PD-TUL-626	ENTRANCE LOCKSET, SATIN CHROME, ORBIT DESIGN
SC-A70LD-ORB-626	CLASSROOM LOCKSET, LESS CYLINDER, SATIN CHROME, ORBIT DESIGN
SC-A70PD-ORB-626	CLASSROOM LOCKSET, SATIN CHROME, ORBIT DESIGN
SC-A80LD-ORB-626	STOREROOM LOCKSET, SATIN CHROME, ORBIT DESIGN
SC-A80PD-ORB-626	STOREROOM LOCKSET, SATIN CHROME, ORBIT DESIGN
SC-A80PD-ORB-605	STOREROOM LOCKSET, POLISHED BRASS, ORBIT DESIGN
SC-A80PD-TUL-605	STOREROOM LOCKSET, POLISHED BRASS, TULIP DESIGN
SC-A80PD-TUL-612	STOREROOM LOCKSET, SATIN BRASS, TULIP DESIGN
SC-AL10S-SAT-626	PASSAGE SET, SATIN CHROME, SATURN LEVER DESIGN
SC-AL40S-SAT-626	PRIVACY LOCKSET, SATIN CHROME, SATURN LEVER DESIGN
SC-AL53S-SAT-626	ENTRANCE LOCKSET, SATIN CHROME, SATURN LEVER DESIGN
SC-AL70S-SAT-626	CLASSROOM LOCKSET, SATIN CHROME, SATURN LEVER DESIGN
SC-AL80S-SAT-626	STOREROOM LOCKSET, SATIN CHROME, SATURN LEVER DESIGN
SC-AL170-JUP-626	DUMMY JUPITER LEVER, SATIN CHROME
SC-AL10S-JUP-626	PASSAGE SET, SATIN CHROME, JUPITER DESIGN
SC-AL40S-JUP-626	PRIVACY LOCKSET, POLISHED BRASS, JUPITER DESIGN
SC-AL53PD-JUP-626	ENTRANCE LOCKSET, SATIN CHROME, JUPITER DESIGN
SC-AL70PD-JUP-626	CLASSROOM LOCKSET, SATIN CHROME, JUPITER DESIGN
SC-AL80PD-JUP-626	STOREROOM LOCKSET, SATIN CHROME, JUPITER LEVER DESIGN

CYLINDERS

Schlage's high quality conventional cylinders provide the standard, normal level of security and functionality for Schlage locks. Using only solid brass bar stock plugs and shells, phosphor bronze springs, nickel silver keys and bottom pins, ensures long life and ease of operation.



1-1/8" SATIN CHROME MORTISE CYLINDERS

SC-20-013-C-626-118	MORTISE CYLINDER, C KEYWAY, ADAMS RITE CAM
SC-20-013-E-626-118	MORTISE CYLINDER, E KEYWAY, ADAMS RITE CAM
SC-20-013-F-626-118	MORTISE CYLINDER, F KEYWAY, ADAMS RITE CAM
SC-30-001-C-118-626	MORTISE CYLINDER, SCHLAGE CAM
SC-30-016-626	I/C CORE MORTISE CYLINDER HOUSING



SATIN CHROME RIM CYLINDERS

SC-20-021C-626	RIM CYLINDER, C KEYWAY
SC-20-021E-626	RIM CYLINDER, E KEYWAY
SC-20-021F-626	RIM CYLINDER, F KEYWAY
SC-20-021-626-1236	RIM CYLINDER, 1236 KEYWAY
SC-20-079-626	I/C CORE RIM CYLINDER HOUSING

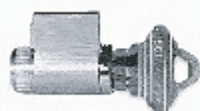

SATIN CHROME KEY-IN-KNOB CYLINDERS & PLUGS

SC-21-002-122-C-626	A-SERIES, 6 PIN K.I.K. CYLINDER, C KEYWAY
SC-21-002-122-CE-626	A-SERIES, 6 PIN K.I.K. CYLINDER, CE KEYWAY
SC-21-002-122-E-626	A-SERIES, 6 PIN K.I.K. CYLINDER, E KEYWAY
SC-21-002-122-EF-626	A-SERIES, 6 PIN K.I.K. CYLINDER, EF KEYWAY
SC-21-002-122-F-626	A-SERIES, 6 PIN K.I.K. CYLINDER, F KEYWAY
SC-33-006E-626	PLUG FOR A,B,D SERIES, E KEYWAY
SC-33-006F-626	PLUG FOR A,B,D SERIES, F KEYWAY



SATIN CHROME (I/C) INTERCHANGEABLE CORE CYLINDERS

SC-23-030-C-626	I/C REMOVABLE CORE C/W CONTROL KEY, C KEYWAY
SC-23-030-E-626	I/C CORE CYLINDER C/W CONTROL KEY, E KEYWAY
SC-23-030-EF-626	I/C CORE CYL. C/W CONTROL KEY, EF KEYWAY
SC-23-030-FG-626	I/C CORE C/W CONTROL KEY, FG KEYWAY

PL SERIES PADLOCKS



Schlage PL-Series padlocks provide single key convenience and standardize security hardware throughout any facility or security area. The PL-Series can be masterkeyed into any new or existing Schlage key system, allowing you to integrate padlocks with door hardware. This eliminates the need for separate keys.

SC-PL1001C BRASS PADLOCK, 5/16" DIAMETER, 1-1/8 INCH SHACKLE CLEARANCE

ORIGINAL SCHLAGE KEYBLANKS



SOLD IN BOXES OF 50 ONLY

SC-KBB35100C	5 PIN C SCHLAGE KEYBLANK	SC-KBB35101EF	6 PIN EF SCHLAGE KEYBLANK
SC-KBB35101C	6 PIN C SCHLAGE KEYBLANK	SC-KBB35101F	6 PIN F SCHLAGE KEYBLANK
SC-KBB35101CE	6 PIN CE SCHLAGE KEYBLANK	SC-KBB35101FG	6 PIN FG SCHLAGE KEYBLANK
SC-KBB35101E	6 PIN E SCHLAGE KEYBLANK		

ORIGINAL SCHLAGE PINS

SC-34-101	LAB TOP PIN (1-.235)	SC-34-202	LAB MASTER PIN (2-.030)	SC-34-300	LAB BOTTOM PIN (0-.165)
SC-34-102	LAB TOP PIN (2-.200)	SC-34-203	LAB MASTER PIN (3-.045)	SC-34-301	LAB BOTTOM PIN (1-.180)
SC-34-103	LAB TOP PIN (3-.165)	SC-34-204	LAB MASTER PIN (4-.060)	SC-34-302	LAB BOTTOM PIN (2-.195)
		SC-34-205	LAB MASTER PIN (5-.075)	SC-34-303	LAB BOTTOM PIN (3-.210)
		SC-34-206	LAB MASTER PIN (6-.090)	SC-34-304	LAB BOTTOM PIN (4-.225)
		SC-34-207	LAB MASTER PIN (7-.105)	SC-34-305	LAB BOTTOM PIN (5-.240)
		SC-34-208	LAB MASTER PIN (8-.120)	SC-34-306	LAB BOTTOM PIN (6-.255)
		SC-34-209	LAB MASTER PIN (9-.135)	SC-34-307	LAB BOTTOM PIN (7-.270)
				SC-34-308	LAB BOTTOM PIN (8-.285)
				SC-34-309	LAB BOTTOM PIN (9-.300)

PARTS

A SERIES PARTS

SC-11-068-626	PASSAGE LATCH (2-3/8 BACKSET)
SC-11-116-626	PASSAGE LATCH (2-3/4 BACKSET)
SC-11-085-626	DEADLATCH (2-3/8 BACKSET)
SC-11-096-626	DEADLATCH (2-3/4 BACKSET)
SC-41-005	5 INCH BACKSET LINK

D SERIES PARTS

SC-14-019-626	ND SERIES DEADLATCH (2-3/4 BACKSET)
SC-14-047-626	DEADLATCH (2-3/8 BACKSET)
SC-43-005	5 INCH BACKSET LINK

L SERIES PARTS

SC-L283-040	SPRING CAGE
SC-L583-254	CAM ONLY (CLOVERLEAF CAM)

NARROW STYLE KEYPAD

The DK-26 operates a 5 Amp DPDT relay to switch any type of fail-safe or fail-secure electric lock (or strike). Release time is programmable from 1-99 seconds. A beeper and three LEDs provide feedback during operation and programming. Power for the DK-26 is 12 to 24 volts, AC or DC. Typically the same power source is used to operate the lock which makes planning the installation simplicity itself. You can even employ an inexpensive AC transformer to operate a DC lock, as the DK-26 will convert AC to DC and supply it to lock.

SN-DK-26SS NARROW STILE KEYPAD WITH CPU



THE TIMEMATE

The TimeMate model TM9 is an ultra-miniature timer that functions to extend momentary switch closures (N/O) up to 36 seconds. It is commonly used in outlet boxes with keyswitches or push button controls, solving the problem of "where to put the timer." The TimeMate either fits in the box or can be mounted on the exterior with the supplied double stick tape. When the switch is operated, the TimeMate's 3 amp SPDT relay energizes for 2 to 36 seconds after which it resets.

SN-TM-9 TIMEMATE, UP TO 36 SECOND MINI TIMER



TOUCH SENSOR PLATE

The SP-1 uses patented touch sensing technology to create a push plate with no moving parts. For indoor use only, the unit is oversized so that it can be mounted over a single gang cut-out. A three part vinyl decal is included and a red LED is incorporated into the backbox.

SN-SP-1 TOUCH SENSOR PLATE



TOUCH SENSOR BAR

The Touch Sense Bar is for use on magnetically locked, non-fire-rated doors. Touching the bar, even through light gloves or clothing, trips an electronic sensor which releases the lock. For indoor use only, the TSB-3 can be installed on metal, aluminum, or wood frame doors of all types. Meets "no special tools or knowledge" code requirements.

SN-TSB-3CL TOUCH SENSE BAR 36 INCH



MAGNALOCK

The Model 32 series provides 600 pounds traffic control security similar to electric strikes, and is recommended for applications where a physical assault on the door is not expected. Primary advantages of the Model 32 are lower cost and more compact size. **NEW:** Now in dual voltage.

SN-M32-12VDC	MAGNALOCK (12VDC - 600 LBS)
SN-M32-24VDC	MAGNALOCK (24VDC - 600 LBS)
SN-Z-32SS	Z MOUNTING BRACKET FOR M32 MAGNALOCK



The Model 62 series offers higher security with 1,200 pounds holding force. Entry cannot be forced without special tools, or before the door or frame gives way. It's recommended not only for high security openings, but for outdoor use on all gate types, too.

SN-M62-12/24VDC	MAGNALOCK (24VDC - 1200 LBS)
SN-Z-62SS	Z MOUNTING BRACKET FOR M62 MAGNALOCK



THE UNLATCH

Securiton's patented UnLatch is a completely new type of electric door releasing device which sweeps away the limitations inherent in traditional electric strike designs. The UnLatch screws into the existing doorframe in seconds. There is no need for routing a special cut-out. This not only saves on installation labor, but maintains the original strength and integrity of the door frame and yields a fully concealed installation for maximum aesthetic appeal.

The UnLatch is highly universal in that one version will operate any North American cylindrical type dead latch or spring latch and installs in wood, steel or aluminum door frames. Unlike conventional electric strikes, the UnLatch also releases under pressure and includes a latch status monitoring output as a standard feature. The UnLatch truly merits being called revolutionary.

SN-UNL-24	UNLATCH, CYLINDRICAL, 24VDC
SN-MUNL-24	UNLATCH, MORTISE, 24VDC



STANDARD TEMPLATE HINGES



SY-BB1409-26D-4-1/2X4
STANDARD 4 1/2" X 4" SATIN CHROME HINGE



SY-BB1509-26D-4-1/2X4
STANDARD BALL BEARING 4 1/2" X 4" SATIN CHROME HINGE



SY-BB1509-26D-4-1/2X4-NRP
STANDARD BALL BEARING 4 1/2" X 4" SATIN CHROME HINGE WITH A NON-REMOVABLE PIN



SY-FBB168-4-1/2X4-26D
ANSI A8111 - Steel
For heavy doors or doors where high frequency is expected, such as entrance doors to office buildings, stores, public buildings and corridor entrance doors to offices
All hinges have template screw hole location for use on either wood or hollow metal doors and frames

Application

Primary consideration is given to the type of door and frame for selection of a proper hinge configuration.

Hinge Size

Determined by door size, thickness, weight, frequency of use, and clearance required.

Hinge Type

The weight of the door and frequency of use determine whether a heavy weight, standard weight anti-friction* bearing or, a plain bearing hinge should be used.

Heavy weight hinges should always be used on heavy doors and doors where high frequency is expected.

BI-METAL HOLE SAW

Starrett bi-metal hole saws are constructed of hardened, heat and abrasion resisting high speed steel teeth with a tough alloy body and cap. This gives them exceptional strength, durability and shatter resistance for user safety. They will cut any wood, metal or plastic in either a hand-held drill or a drill press.



SR-KS288 BI-METAL HOLE SAW

Contents No. of Saws Saw Diameters

Inch	mm
6 7/8"	22
1"	25
1 1/2"	38
1 3/4"	44
2 1/8"	54

Accessories

A1 Arbor for 3/8" (9.5 mm) Chuck

A10 Quick-Hitch Arbor for 3/8" (9.5 mm) Chuck



SR-KV292 FAST CUT LOCKSET KIT

KEY CADDY'S

Heavy-duty chrome-plated die-cast case with extra-long stainless steel chain and large key ring. Returns keys and other articles automatically. Ideal for custodians, maids, watchmen, service station attendants and many others. Also great for welders to carry torch igniters.

**CLIP ON
SR-SK1**

**BELT LOOP
SR-SK2**

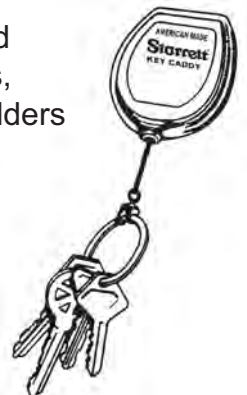

ST/SP-A-19-100	ACURA- HONDA KIT	ST/SP-P-40-201	FORD FACE CAP - ASPIRE,10/PK
ST/SP-P-13-102	BMW # 2 TUMBLER 25 PK	ST/SP-P-42-140	FORD SPRING,50/PK
ST/SP-P-13-103	BMW TUMB #3 25/PK	ST/SP-P-42-141	FORD 10-CUT DR LK TUMB,25/PK
ST/SP-P-13-104	BMW #4 TUMBLER 25PK	ST/SP-P-42-142	FORD 10-CUT DR LK TUMB,25/PK
ST/SP-D-33-204	CHEV METRO DK LSP	ST/SP-P-42-143	FORD 10-CUT DR LK TUMB,25/PK
ST/SP-D-42-248	CONT/MYST DR LK LH	ST/SP-P-42-144	FORD 10-CUT DR LK TUMB,25/PK
ST/SP-P-42-234	CONT/MYST DUST SHUTTER CHR,5PK	ST/SP-P-42-145	FORD 10-CUT DR LK TUMB,25/PK
ST/SP-P-42-278	CONTOUR (VALEO)DR LK FACE CP5PK	ST/SP-P-42-190	FORD 10-CUT SB TUMB SPRG,50/PK
ST/SP-A-16-100	DATSUN COMBO KEYING KIT	ST/SP-P-42-191	FORD 10-CUT SB IGN TUMB#1,25PK
ST/SP-A-16-100	DATSUN COMBO KEYING KIT	ST/SP-P-42-192	FORD 10-CUT SB IGN TUMB#2,25PK
ST/SP-A-16-104	DATSUN/SUBARU KEYING KIT	ST/SP-P-42-193	FORD 10-CUT SB IGN TUMB#3,25PK
ST/SP-C-16-106	DAT IGN CODED LONG TYPE	ST/SP-P-42-194	FORD 10-CUT SB IGN TUMB#4,25PK
ST/SP-D-16-206	DAT/NISSAN DR LK S/A	ST/SP-P-42-195	FORD 10-CUT SB IGN TUMB#5,25PK
ST/SP-P-16-105	DATSUN LK SPRING 50 PK	ST/SP-P-42-201	FORD FACE CAP,10/PK
ST/SP-P-16-161	DAT/NISSAN IGN TUMB 25 PK	ST/SP-P-42-202	FORD FACE CAP BLK,10/PK
ST/SP-P-16-162	DAT/NISSAN IGN TUMB 25 PK	ST/SP-P-42-203	FORD FACE CAP,10/PK
ST/SP-P-16-163	DAT/NISSAN IGN TUMB 25 PK	ST/SP-P-42-222	FORD FACE CAP '94 LH,5/PK
ST/SP-P-16-164	DAT/NISSAN IGN TUMB 25 PK	ST/SP-P-42-231	FORD DUST COVER CHR,5/PK
ST/SP-P-16-205	DATSUN FACE CAP 10 PK	ST/SP-P-42-265	FORD 8-CUT RND FACE CAP BLK,10
ST/SP-P-16-206	DATSUN FACE CAP BLK 10 PK	ST/SP-P-42-288	FORD 10-CUT SB SEAL PLATE,25PK
ST/SP-P-16-213	DAT/NIS FACE CAP 10 PK	ST/SP-P-42-303	FORD DR LK T-PIECES(PLASTIC)UN
ST/SP-P-42-316	ESCORT DR LEVER LH CAM	ST/SP-A-41-150	GM - HUF - COMBINATION KEYING
ST/SP-C-42-193	ESCT/TRCR IGN UNCOD 91-96 1/2	ST/SP-A-41-152	GM COMBINATION KIT 2003+UP
ST/SP-C-42-194	ESCT/TRCR IGN UNCOD 91-96 AUT	ST/SP-D-33-101	GM/SUZ DR LOCK
ST/SP-D-20-109	FORD PROBE DR LK	ST/SP-A-19-108	HONDA 4 TRACK KIT
ST/SP-D-42-208	FORD DR LK SVC PKG	ST/SP-C-19-112	HONDA ACCORD IGN LK CYL 92-93
ST/SP-D-42-210	FORD DR LK SVC PKG LH	ST/SP-C-19-113	HONDA CIVIC IGN LK 92-95
ST/SP-D-42-211	FORD DR LK SVC PKG RH	ST/SP-D-19-110	HONDA DR LK CODED
ST/SP-D-42-212	FORD DR LK SVC PKG LH	ST/SP-D-19-308	HONDA DR PLUG
ST/SP-D-42-217	FORD DR LK SVC PKG RH	ST/SP-D-19-309	HONDA DR PLUG
ST/SP-D-42-221	FORD 10 CUT DR LK SVC PKG	ST/SP-P-19-100	HONDA LK SPRING 50 PK
ST/SP-D-42-222	FORD 10 CUT DR LK SVC PKG	ST/SP-P-19-111	HONDA DR TUMB 25 PK
ST/SP-D-42-231	FORD DR/DK SVC PKG	ST/SP-P-19-112	HONDA DR TUMB 25 PK
ST/SP-D-42-232	FORD DR/DK SVC PKG BLK	ST/SP-P-19-113	HONDA DR TUMB 25 PK
ST/SP-D-42-238	FORD W/O LITE DR SVC LH	ST/SP-P-19-122	HONDA IGN TUMB #2 25 PK
ST/SP-D-42-291	FORD DR LK SVC PKG	ST/SP-P-19-123	HONDA IGN TUMB #3 25 PK
ST/SP-D-42-302	FORD DR/DK LK PLUG	ST/SP-P-19-141	HONDA IGN/DR TUMB 25 PK
ST/SP-A-42-104	FORD KEYING KIT	ST/SP-P-19-142	HONDA IGN/DR TUMB 25 PK
ST/SP-A-42-111	FORD 10 CUT IGNITION KIT	ST/SP-P-19-143	HONDA IGN/DR TUMB 25 PK
ST/SP-A-42-150	FORD COMB KEYING KIT	ST/SP-P-19-144	HONDA IGN/DR TUMB 25 PK
ST/SP-B-40-103	FORD DK LK	ST/SP-P-19-145	HONDA IGN/DR TUMB 25 PK
ST/SP-B-42-126	FORD DK LK	ST/SP-P-19-146	HONDA IGN/DR TUMB 25 PK
ST/SP-B-42-129	FORD DK LK W/O ALARM	ST/SP-P-36-201	HYUNDAI FACE CAP,10/PK
ST/SP-B-42-130	FORD DK LK BLK	ST/SP-P-24-102	ISUZU TUMB #2,25/PK
ST/SP-B-42-135	FORD DK LK	ST/SP-P-24-103	ISUZU TUMB #3,25/PK
ST/SP-C-42-117	FORD IGN UNCOD SMALL EARS CHR	ST/SP-P-24-104	ISUZU TUMB #4,25/PK
ST/SP-C-42-127	FORD IGN UNCOD SMALL EARS BLK	ST/SP-P-20-142	MAZDA WAFFER,25/PK
ST/SP-C-42-137	FORD IGN UNCOD DOME CHROME	ST/SP-P-20-144	MAZDA WAFFER,25/PK
ST/SP-C-42-147	FORD IGN UNCOD LGE EARS BLK	ST/SP-P-20-153	MAZDA WAFFER,25/PK
ST/SP-C-42-157	FORD IGN UNCOD LGE EARS CHROME	ST/SP-P-20-154	MAZDA WAFFER,25/PK
ST/SP-C-42-167	FORD IGN UNCOD CONTOUR/MYST	ST/SP-P-20-155	MAZDA WAFFER,25/PK
ST/SP-C-42-188	FORD FOCUS IGN	ST/SP-P-20-162	MAZDA DR TUMB,25/PK
ST/SP-C-42-407	FORD IGN CYL CHR STR=609485	ST/SP-P-20-163	MAZDA DR TUMB,25/PK
		ST/SP-P-20-164	MAZDA DR TUMB,25/PK

ST/SP-P-20-142	MAZDA WAFFER,25/PK	ST/SP-P-30-211	TOYOTA FACE CAP,10/PK
ST/SP-P-20-144	MAZDA WAFFER,25/PK	ST/SP-P-30-214	TOYOTA FACE CAP,10/PK
ST/SP-P-20-153	MAZDA WAFFER,25/PK	ST/SP-P-30-217	TOYOTA FACE CAP,10/PK
ST/SP-P-20-154	MAZDA WAFFER,25/PK	ST/SP-P-30-218	TOYOTA FACE CAP,10/PK
ST/SP-P-20-155	MAZDA WAFFER,25/PK	ST/SP-P-30-266	TOYOTA DK CAP,10/PQ
ST/SP-P-20-162	MAZDA DR TUMB,25/PK	ST/SP-P-33-101	SUZ/GEO/MAZDA MPV WAFFER,25/PK
ST/SP-P-20-163	MAZDA DR TUMB,25/PK	ST/SP-P-33-102	SUZ/GEO/MAZDA MPV WAFER,25/PK
ST/SP-P-20-164	MAZDA DR TUMB,25/PK	ST/SP-P-33-103	SUZ/GEO MAZDA MPV WAFER,25/PK
ST/SP-P-20-206	MAZDA FACE CAP,10/PK	ST/SP-P-33-104	SUZ/GEO MAZDA MPV WAFER,25/PK
ST/SP-P-20-207	MAZDA FACE CAP BLK,10/PK	ST/SP-P-33-105	SUZ/GEO MAZDA MPV WAFER,25/PK
ST/SP-P-20-209	MAZDA FACE CAP,10/PK	ST/SP-P-36-201	HYUNDAI FACE CAP,10/PK
ST/SP-P-20-211	MAZDA FACE CAP,10/PK	ST/SP-P-40-201	FORD FACE CAP - ASPIRE,10/PK
ST/SP-P-20-216	MAZDA FACE CAP,10/PK	ST/SP-P-42-140	FORD SPRING,50/PK
ST/SP-P-20-217	MAZDA FACE CAP,10/PK	ST/SP-P-42-141	FORD 10-CUT DR LK TUMB,25/PK
ST/SP-P-20-218	MAZDA FACE CAP,10/PK	ST/SP-P-42-142	FORD 10-CUT DR LK TUMB,25/PK
ST/SP-P-20-231	MAZDA DUST COVER,5/PK	ST/SP-P-42-143	FORD 10-CUT DR LK TUMB,25/PK
ST/SP-P-20-265	MAZDA FACE CAP,10/PK	ST/SP-P-42-144	FORD 10-CUT DR LK TUMB,25/PK
ST/SP-P-24-102	ISUZU TUMB #2,25/PK	ST/SP-P-42-145	FORD 10-CUT DR LK TUMB,25/PK
ST/SP-P-24-103	ISUZU TUMB #3,25/PK	ST/SP-P-42-190	FORD 10-CUT SB TUMB SPRG,50/PK
ST/SP-P-24-104	ISUZU TUMB #4,25/PK	ST/SP-P-42-191	FORD 10-CUT SB IGN TUMB#1,25PK
ST/ SP-P-30-105	TOYOTA LK SPRING,50/PK	ST/SP-P-42-192	FORD 10-CUT SB IGN TUMB#2,25PK
ST/SP-P-30-106	TOYOTA RETAIN TUMB,10/PK	ST/SP-P-42-193	FORD 10-CUT SB IGN TUMB#3,25PK
ST/SP-P-30-108	TOYOTA LK SPRING,50/PK	ST/SP-P-42-194	FORD 10-CUT SB IGN TUMB#4,25PK
ST/SP-P-30-141	TOYOTA IGN/DR TUMB,25/PK	ST/SP-P-42-195	FORD 10-CUT SB IGN TUMB#5,25PK
ST/SP-P-30-142	TOYOTA IGN/DR TUMB,25/PK	ST/SP-P-42-201	FORD FACE CAP,10/PK
ST/SP-P-30-143	TOYOTA IGN/DR TUMB,25/PK	ST/SP-P-42-202	FORD FACE CAP BLK,10/PK
ST/SP-P-30-144	TOYOTA IGN/DR TUMB,25/PK	ST/SP-P-42-203	FORD FACE CAP,10/PK
ST/SP-P-30-161	TOYOTA IGN/DR TUMB,25/PK	ST/SP-P-42-222	FORD FACE CAP '94 LH,5/PK
ST/SP-P-30-162	TOYOTA IGN/DR TUMB,25/PK	ST/SP-P-42-231	FORD DUST COVER CHR,5/PK
ST/SP-P-30-163	TOYOTA IGN/DR TUMB,25/PK	ST/SP-P-42-234	CONT/MYST DUST SHUTTER CHR,5PK
ST/SP-P-30-164	TOYOTA IGN/DR TUMB,25/PK	ST/SP-P-42-265	FORD 8-CUT RND FACE CAP BLK,10
ST/SP-P-30-181	TOYOTA IGN/DR TUMB,25/PK	ST/SP-P-42-278	CONTOUR (VALEO)DRLK FACE CP5PK
ST/SP-P-30-182	TOYOTA IGN/DR TUMB,25/PK	ST/SP-P-42-288	FORD 10-CUT SB SEAL PLATE,25PK
ST/SP-P-30-183	TOYOTA IGN/DR TUMB,25/PK	ST/SP-P-42-303	FORD DR LK T-PIECES(PLASTIC)UN
ST/SP-P-30-184	TOYOTA IGN/DR TUMB,25/PK	ST/SP-P-42-316	ESCORT DR LEVER LH CAM
ST/SP-P-30-185	TOYOTA IGN/DR TUMB,25/PK		
ST/SP-P-30-186	TOYOTA IGN/DR TUMB,25/PK		
ST/SP-P-30-187	TOYOTA IGN/DR TUMB,25/PK		
ST/SP-P-30-201	TOYOTA FACE CAP,10/PK		
ST/SP-P-30-206	TOYOTA FACE CAP,10/PK		
ST/SP-P-30-208	TOYOTA FACE CAP,10/PK		
ST/SP-P-30-209	TOYOTA FACE CAPBLK,10/PK		
ST/SP-P-30-210	TOYOTA FACE CAP,10/PK		



KEY STORAGE

GE AccessPoint Key Organizer



The GE AccessPoint Key Organizer helps you keep your keys in one central location in this designer key organizer that mounts easily. Organize everyday items such as key rings, cell phones and wallets in cups on the outside. Concealed, inner cabinet stores backup keys with identification labels.

The Key Organizer Dimensions:
11 1/2" High x 5 1/4" Wide x
3 1/2" Deep

SU-001933-BLACK

GE AccessPoint Key Cabinet



Key cabinet that stores all of your keys in one place on peg hooks or removable key tags with labels for easy identification. Modern design that mounts easily with spring-loaded door.

The Key Organizer Dimensions:
14" High x 9.563" Wide x 2.75" Deep

SU-001934-SILVER 10 HOOK KEY CABINET
SU-001935-SILVER ELECTRONIC KEYPAD



Key Cabinet Pro

These heavy-duty steel key cabinets Includes numbered key tags with key rings and lock location chart for easy reference.

- 16 gauge steel construction
- More depth for larger key rings
- Keys hang directly on hooks

SU-001795 PUSHBUTTON LOCK (30 KEYS)
SU-001796 PUSHBUTTON LOCK (60 KEYS)
SU-001797 PUSHBUTTON LOCK (120 KEYS)



Touch Point

TouchPoint Pushbutton Lock combines convenience and security. The entry code can be changed as often as you like to over a thousand different combinations.

SU-001801 KEYED 30 KEY CABINET



TouchPoint Lock

TouchPoint is designed to replace a standard cam lock in a variety of storage cabinets or enclosures. It consists of a solid die cast body with a ten-digit changeable combination and a clutch mechanism to turn the cam.

The TouchPoint lock can be mounted on top of the door surface or flush mounted into the door.

SU-001798 TOUCHPOINT LOCK (KEYLESS CAM LOCK)

Organize your life

Supra

GE Security AccessPoint KeySafe



The White GE Security AccessPoint KeySafe secures a single key so homeowners can safely store spare keys for themselves, children, relatives, friends, neighbors, emergency access, housekeepers, contractors, service professionals or anyone they wish to let into their homes and if necessary, it is quick and easy to change the combination pushbutton lock.

SU-001912-BEIGE

GE Access Point Digital KeySafe



Electronic time stamp records the last nine access events. The LCD display shows last 9 access times. Low profile, subtle design compliments a door frame. Change the code anytime for added security. Solid weather-resistant metal construction. Mounts easily, hardware included. This box is great for children, friends, neighbors, emergency access, contractors, rental managers, realtors and other service personnel.

SU-001913-BEIGE



GE Access

KEY-SAFE KEY BOXES

Portable

Pushbutton or Spin-Dial version hangs easily on a doorknob, fence, railing or pipe. Just open the lid, lift the shackle and hang. No tools are necessary. Portable KeySafe Pro is constructed of sturdy metal with protective rubber cover and is guaranteed never to rust.

Permanent

Permanent KeySafe original holds up to five keys and attaches securely to any wall or flat surface with mounting hardware included. The StrongBox design has a solid track record for unmatched quality and security.



SU-C3-PUSHBUTTON



SU-C3-COMBINATION



SU-S6-PUSHBUTTON



SU-134174



SU-001095



SU-S7-PUSHBUTTON

STORAGE SOLUTIONS



Key Strip

A unique wall-mounted key holder that offers consumers an affordable, convenient way to access keys on a daily basis. Holds up to ten key rings.

SU-001932 GE KEY STRIP



STOR-A-KEY

Key case with powerful magnet that attaches to almost any clean surface. Stor-A-Key can be used for emergency access to vehicles or in your home. Weather resistant plastic will not rust. Foam insert and strap keeps key in place.

SU-001902 GE LOCK STOR-A-KEY



Portable Stor-A-Key

Portable key case with resettable combination lock and adjustable cable. The adjustable cable hooks almost anywhere.

SU-001956 GE PORTABLE STOR-A-KEY



Locking Stor-A-Key

Locking key case with resettable combination and powerful magnet. Spare key storage for auto, home, boat, office files, etc. Attach Locking Stor-A-Key anywhere using magnet or double sided taped metal plate. Easy key retrieval and foam insert to keep key from falling out. Equipped with anchor point for strap or cable tie.

SU-001901 GE MAGNETIC STOR-A-KEY

THOMAS WEATHERSTRIP

ASTRAGALS

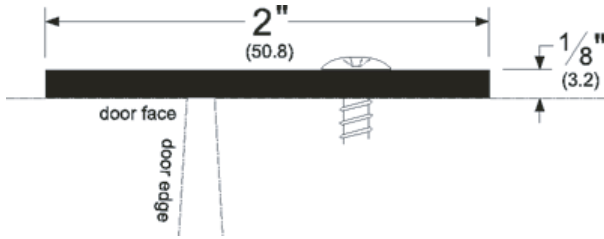

Astragal and meeting stile seals are used to seal the gap between a pair of doors.

- TP-357C-7FT-AL ALUMINUM ASTRAGAL
- TP-357D-7FT-DURO DURODONIC ASTRAGAL

THRESHOLDS



- STANDARD FASTENERS - #14 Stainless steel wood screws x expansion shields
- Saddle type with fluted abrasive surface (flute details may vary slightly)
- Panic type with solid abrasive surface
- Drilled 6" from each end to allow field cutting or notching
- Cast Threshold dimensions shown below are nominal. Tolerance +/- 1/16".



ADA Compliant



UL 10B Classified on wood doors up to 90 min.
UL 10B Classified on metal doors up to 3 hr.



UL 10C Classified on wood doors up to 90 min.
UL 10C Classified on metal doors up to 3 hr.



ANSI/BHMA Certified



Slip Resistant

- TP-4425-3FT-AL 5" WIDE, 1/2" HIGH, 36" LENGTH
- TP-4425-6FT-AL 5" WIDE, 1/2" HIGH, 72" LENGTH

DOOR SEALS



TP-4441-17FT-AL DOOR SEAL, TEK SCREWS

AUTOMATIC DOOR BOTTOM

- Features
- 1-13/16" H. X 1/2" W. Regular
 - duty surface mount.

- Ratings
- Fire rated.

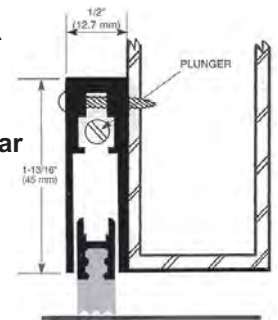

TP-CT50-36" 36" AUTOMATIC DOOR BOTTOM

DOOR SWEEPS

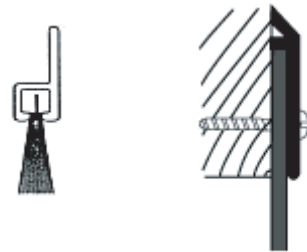

- #6 x 3/4" Stainless Steel Sheet Metal Screws furnished.
- Screw holes are slotted for adjustment.
- Neoprene is black

NEOPRENE DOOR SWEEP

- TP-2100S-3FT-AL 36" LENGTH
- TP-2100S-4-FEET-628 48" LENGTH

NYLON DOOR SWEEP

- TP-4480S-3FT-ALUM 36" LENGTH
- TP-4480S-4FT-ALUM 48" LENGTH

COMPX TIMBERLINE REMOVABLE LOCK PLUG SYSTEM

- Wide Selection of Locks to Fit Most Furniture & Cabinet Applications
- Available in Several High Quality Finishes
- Removable Lock Plugs For Complete Keying Versatility
- Pre-Packaged in Poly-bags for Easy Distribution to Your Customer

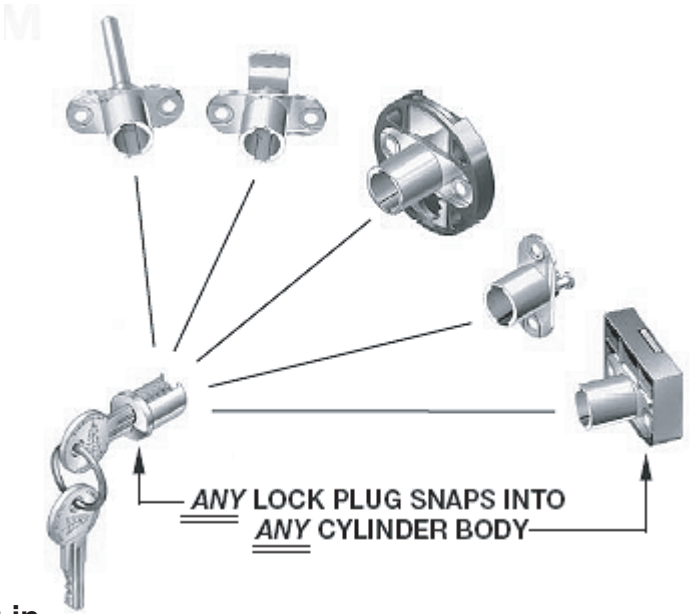

Most Timberline Locks are designed for mounting in 3/4" panels, with or without a veneer or laminate face.

LOCK PLUGS FOR ALL LOCK TYPES

Lock Features:

- Small Diameter
- High Quality/Long Life
- Solid Brass Keys
- Coded on Face & Keys
- Master-Keyed Standard
- Removable Lock Plug



BEZEL TRIM RINGS

TB-C100BZ-14A	NICKEL
TB-C200BZ-8	OLD ENGLISH
TB-C300BZ-19	BLACK
TB-C400BZ-20	STATUARY BRONZE
TB-C500BZ-3	BRASS



POLISHED NICKEL	
TB-C100LP-14A-KA-100T	KEYED ALIKE
TB-C100LP-14A-KA-101T	KEYED ALIKE
TB-C100LP-14A-KD	KEYED DIFFERENT

OLD ENGLISH (SPRAYED GOLD)	
TB-C200LP-8-KA-100T	KEYED ALIKE
TB-C200LP-8-KA-101T	KEYED ALIKE
TB-C200LP-8-KD	KEYED DIFFERENT

BLACK	
TB-C300LP-19-KA-100T	KEYED ALIKE
TB-C300LP-19-KA-101T	KEYED ALIKE
TB-C300LP-19-KA-102T	KEYED ALIKE
TB-C300LP-19-KA-103T	KEYED ALIKE
TB-C300LP-19-KD	KEYED DIFFERENT

STATUARY BRONZE	
TB-C400LP-20-KA-100T	KEYED ALIKE
TB-C400LP-20-KA-101T	KEYED ALIKE
TB-C400LP-20-KD	KEYED DIFFERENT

POLISHED BRASS	
TB-C500LP-3-KA-100T	KEYED ALIKE
TB-C500LP-3-KA-101T	KEYED ALIKE
TB-C500LP-3-KD	KEYED DIFFERENT

DOOR LOCKS

- Application - Surface mounted lock for locking doors.
- Operation - 180° key rotation, CCW to lock, key removable in both locked and unlocked positions.
- Keying - Order lock plug separately
- Packaging - Housing is black, toughened nylon. Cylinder is unplated. Cams are zinc plated.
- Case quantity 25.



TB-C240CB



TB-C290CB

DRAWER LOCKS

- Application - Surface mounted lock for locking drawers.
- Operation - 180° key rotation, CCW to lock, key removable in both locked and unlocked positions.
- Keying - Order lock plug separately
- Packaging - Cylinder is black, toughened nylon. Cylinder is unplated. Cams are zinc plated.
- Case quantity 25.



TB-C230CB

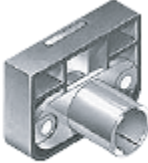

TB-C280CB

CAM LOCK KITS

- Application - Universal type lock for either doors or drawers. Each kit contains a variety of easily switched cams to accommodate most locking situations.
- Operation - 90° & 180° cam rotation, CCW to lock.
- Keying - Order lock plug separately.
- Packaging - Cylinder supplied with two straight and bent cams. Bent cams have setback of 15/32". Cylinder is unplated.
- Case quantity 25.

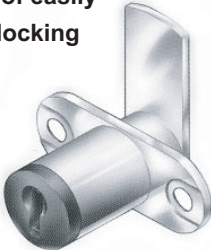

TB-C165CB

GANG LOCKS



TB-D100CB

- FRONT MOUNT SYSTEM 100**
- Front gang locks are designed to be mounted on the front of the cabinets and lock several drawers at one time

SIDE MOUNT SYSTEM 150

- Side gang locks are designed to be mounted on the side of the cabinets and lock several drawers at one time



TB-D150CB



TB-D270CB

TWO DRAWER SIDE GANG LOCK

- Two drawer gang lock for locking two pedestal drawers with a single lock. Lock mounts on side of cabinet.

DOUBLE DOOR LOCK

- Surface mounted lock for locking two adjacent doors. Eliminates the need for a spring catch on the door opposite the lock. Works with either overlay or inset doors



TB-C250CB

DOUBLE DOOR LOCK

- Universal type lock for either doors or drawers that can accommodate panel thickness from 7/8" to 1-3/8" thick.



TB-C170CB

BYPASS LOCK

- Application - For locking sliding, bypass type doors. Requires 3/4" hole in front door for cylinder.
- Operation - Pushing in cylinder locks doors, with or without key. 45° key rotation allows cylinder to pop back out to unlock doors. Key removable in both locked and unlocked positions.

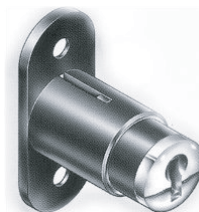

TB-C175CB

PARTS AND ACCESSORIES



TB-C100SP-19
STRIKE PLATE



TB-C101SP-19
STRIKE PLATE



TB-C165DB
16.5MM DRILL



TB-C185SP-19
STRIKE PLATE



TB-C257SP-19
STRIKE PLATE



TB-D300KY
SOLD IN
MULTIPLES OF 10



TB-C500DC-19
STRIKE PLATE



TB-D500KY
CHANGE TOOL

Tufoil® Lubit 8®



Lubit-8

is a versatile, general-purpose lubricant of sophisticated technology and outstanding performance. It prevents rust and acts as a cleaning agent.

It can stop locks from freezing or penetrate deeply to free "frozen" nuts and bolts. Some of the more popular applications for Lubit-8 include...

(1) LUBIT-8-ASSORMENT 36PC. DISPLAY

(1) LUBIT-8



- Precision bearings
- Door locks and hinges
- Nuts and bolts
- Small motors
- Power tools
- Window hardware
- Sewing machines
- Computers, printers and typewriters

PANIC DEVICES

22 SERIES

FEATURES

- Nonhanded
- Latch bolt deadlocking
- Field sizeable
- (19mm) throw, latch bolt
- Hex key dogging
- Aluminum finish

The economical alternative, incorporating a modern touch bar styling for all types of doors. Available in rim and surface vertical rod styles

- VD-22EO-689
- VD-22EO-F-689
- VD-2227EO-689

RIM DEVICE, EXIT ONLY
RIM DEVICE (FIRE RATED)
SURFACE VERTICAL ROD PANIC DEVICE
DOES UP TO A 7'0" DOOR HEIGHT



VD-22EO-689

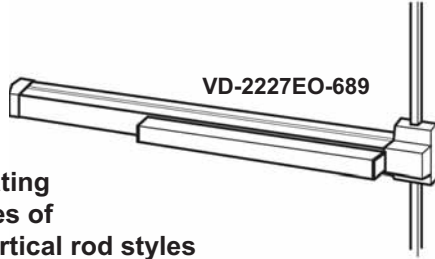

VD-2227EO-689



VD-210K-689
CLASSROOM



VD-230NL-689
NIGHT LATCH



VD-210NL-689
NIGHT LATCH



VD-230TP-689
VD-230TP-BE-689 (PASSAGE)



VD-230L-06-689-LHR
VD-230L-06-689-RHR
KEY LOCKS AND UNLOCKS
LEVER TRIM

35 SERIES

FEATURES

- Nonhanded
- Latch bolt deadlocking
- Field sizeable
- (19mm) throw, latch bolt
- Hex key dogging

- VD-35AEO-626
- VD-3527A-EO-628
- VD-3547A-EO-626

NARROW RIM DEVICE, EXIT ONLY, SATIN CHROME
SURFACE VERTICAL ROD EXIT DEVICE
CONCEALED VERTICAL ROD

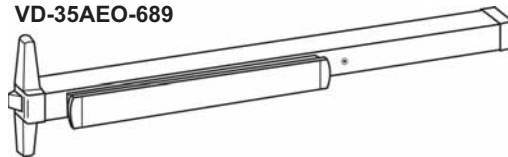

VD-35AEO-689

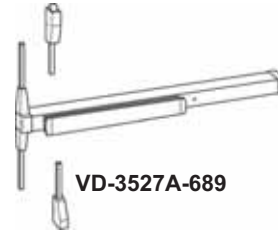

VD-3527A-689

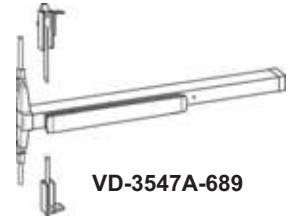

VD-3547A-689

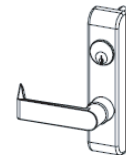

VD-360L-03-626-LHR REVERSIBLE

KEY LOCKS AND UNLOCKS
LEVER TRIM

44 SERIES

FEATURE

- Field sizeable
- (19mm) throw, latch bolt
- Hex key dogging

For all types of single and double doors with mullion, UL approved for accident hazard installations. Fits door stiles as narrow as 3 3/8".

- VD-44EO-689
- VD-44TP-689

RIM DEVICE, EXIT ONLY
EXIT DEVICE WITH THUMBPIECE TRIM

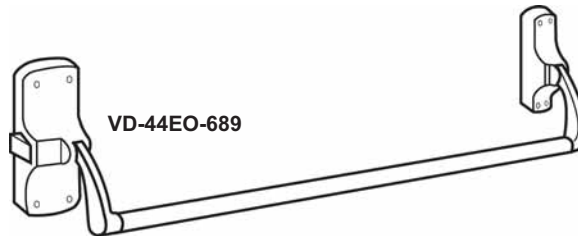

VD-44EO-689



44TP-689

PANIC DEVICES

88 SERIES

FEATURES

- Field reversible
- Field sizeable
- Hex key dogging
- 3/49 (19mm) throw latch bolt

A traditional crossbar design with proven service on rugged applications. Available in rim, mortise, surface and concealed vertical rod mountings. For all types of flush and wide stile doors, and fits 86 and 161 stock hollow metal cutouts.

- | | |
|----------------|---|
| VD-88EO-626 | RIM DEVICE, EXIT ONLY, SATIN CHROME |
| VD-8827EO-626 | VERTICAL ROD EXIT DEVICE, SATIN CHROME |
| VD-88L-626-LHR | EXIT DEVICE (C/W 373L KEY LOCKING TRIM) |
| VD-88L-626-RHR | EXIT DEVICE (C/W 373L KEY LOCKING TRIM) |
| VD-88TP-626 | PANIC BAR WITH THUMBPIECE TRIM |

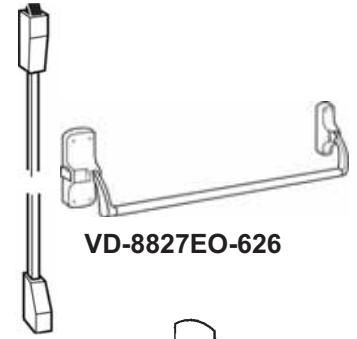
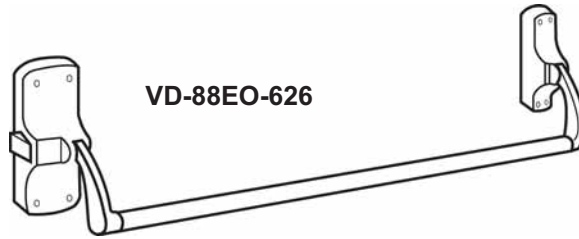

88TP-626
LESS CYLINDER

98 SERIES

Modern touch bar styling for heavy traffic applications. Available in rim, mortise lock, surface and concealed vertical rod mountings. Designed for use on flush and wide stile doors, and fits 86 and 161 stock hollow metal cutouts.

Devices are UL listed Panic Hardware (FVSR) SA163 (N). Fire devices (F) are UL listed Fire Exit Hardware (GXHX) R4504 (N), A label. Tested in accordance to ANSI A156.3, 1989, Grade 1.

- | | |
|-----------------|--|
| VD-98EO-626-4FT | EXIT ONLY, 4' LENGTH, SATIN CHROME |
| VD-98EO-626 | EXIT ONLY, 3' LENGTH, SATIN CHROME |
| VD-98EO-628 | EXIT ONLY, 3' LENGTH, ALUMINUM |
| VD-98EO-F-626 | FIRE-RATED, EXIT ONLY, 3' LENGTH |
| VD-9827EO-F-628 | FIRE-RATED SURFACE MOUNT VERTICAL ROD EXIT |

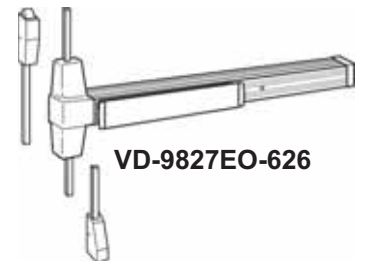
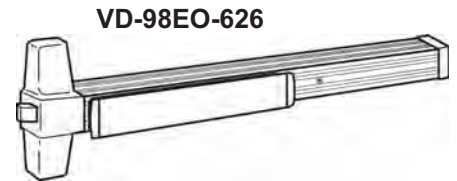

VD-990NL-689
NIGHT LATCH



VD-990TP-689
VD-990TP-BE-689 (PASSAGE)

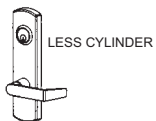

VD-996L-689
NIGHT LATCH

- | | |
|---------------------------|--|
| VD-990NL-R/V-626 | PULL TRIM FOR 98/99 SERIES EXIT DEVICE |
| VD-990TP-R/V-626-BE | THUMBPIECE TRIM FOR 98/99 (NO HOLE) |
| VD-990TP-R/V-626 | THUMBPIECE TRIM FOR 98/99 RIM/VERTICAL |
| VD-992L-R/V-06-626-LHR | LEVER TRIM FOR 98 PANIC DEVICE |
| VD-992L-R/V-06-626-RHR | LEVER TRIM FOR 98 PANIC DEVICE |
| VD-996L-NL-R/V-03-626-RHR | LEVER TRIM FOR 98/99 (NIGHT LATCH) |
| VD-996L-R/V-06-626-RHR | CLASSROOM |
| VD-996L-R/V-06-626-LHR | CLASSROOM |



GUARD-X EXIT ALARM

The Series 2670 Exist Alarm Lock provides secure protection through a large stainless steel deadbolt, which is 2" x 1/2" (51mm x13mm) and has over a 3/4" (19mm) throw. The engagement area into the strike is over 1-1/4 (32mm) square inches. The cast aluminum latch case protects the internal mechanism and resists tampering or vandalism from inside the door.

VD-2670-GUARD-X-628 VON DUPRIN EXIT ALARM LOCK



MULLIONS

The Von Duprin Mullion now carries the UL fire label for openings up to 8'0". It delivers single-door performance and security on double fire-door applications.

VD-4954-689 REMOVABLE MULLION 7' 2"

PARTS

VD-050054-689
 VD-050070
 VD-050091-US26D
 VD-050115-28
 VD-050237-00
 VD-050254-00
 VD-050390
 VD-050400-01
 VD-050401-00
 VD-050491
 VD-050496
 VD-050512
 VD-050514
 VD-050534
 VD-050566-US26D
 VD-090081
 VD-090083
 VD-110NL-MD-US26D
 VD-222-(091080-00)
 VD-227-(090085)
 VD-22ALK-SP28
 VD-35/98CDK-628
 VD-7500-32D
 VD-871-2
 VD-88AXLE
 VD-900309-US26D
 VD-900887
 VD-900892-US28
 VD-968601
 VD-971573-00
 VD-98ALK-US28
 VD-EPT10-SP28
 VD-EPT2-SP28
 VD-PS873

MULLION STABILIZER SET
 EL CONVERSION KIT-3'
 22/98/9927/-F TOP LATCH BRACKET KIT
 CYLINDER DOGGING KIT FOR 33/98 PANIC
 SOLENOID ONLY FOR 6200 STRIKE (12VDC)
 LX SWITCH KIT 3'DEVICE
 BOTTOM FITTING (4754/4854/4954) MULLIONS
 TOP LATCH KIT LESS COVER 22/33/98/9827
 BOTTOM LATCH KIT LESS COVER 22/33/98/27
 SHOCK ABSORBER
 LATCH COVER KIT C/W SCREWS 22/33/9827
 TOP ROD KIT (22/33/98/9827)
 BOTTOM ROD KIT 22/33/98/9827
 POTTED CIRCUIT BREAKER (EL SOLENOID)
 98/9927/27-F LATCH CASE COVER KIT
 WEDGETITE SCREW
 88 SERIES DOG SCREW
 CYLINDER ASSEMBLY
 DOGGING KEY (LARGE)(ALSO MONARCH 19RBA)
 DOGGING KEY (SMALL) FOR 22,44,55,88,99
 ALARM KIT FOR 22 SERIES EXIT DEVICE
 CYLINDER DOGGING KIT FOR 35/98 SERIES
 MORTISE LOCK
 2 ZONE CONTROLLER FOR PS873 POWERSUPPLY
 88 SERIES AXLE ASS'Y (090082)
 98/9947/47-F SECURITY SCREW PACKAGE
 22 END CAP BRACKET & SCREWS
 98/99 CENTRE CASE SCREWS
 22 SERIES END CAP
 LIFT SPRING FOR 992L
 ALARM KIT FOR 98 EXIT DEVICE (S2 SWITCH)
 TEN 24 GAUGE WIRES ELECTRIC POWER TRANSFERS
 TWO 18 GAUGE WIRES ELECTRIC POWER TRANSFER
 POWER SUPPLY

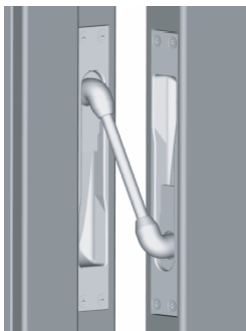

EPT2 / EPT10

ELECTRIC STRIKES

5100 SERIES

The 5100 Electric Strike has been designed and manufactured to meet the needs of locksmiths and security professionals. This easy-to-install electric strike was created for medium duty applications, specifically to control traffic flow through interior and exterior openings in retail and commercial environments.

- Three faceplates included for hollow metal, wood or aluminum frames.
- Internal 12/24 dual-voltage solenoid.
- Adjustable keeper.
- Fail-safe/fail-secure selectability.

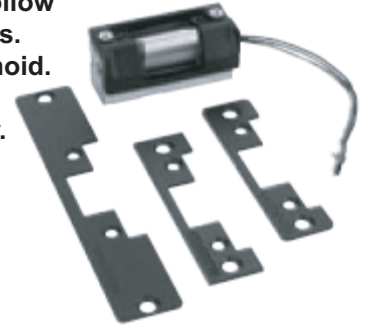

VD-5100-689-12/24VDC ELECTRIC STRIKE WITH 3 FACEPLATES

6000 SERIES

Von Duprin is the leading manufacturer of premium, heavy-duty electric strikes known for their reliability, durability and security. Electric Strikes provide remote release of a locked door. They allow the door to be opened without retracting the latchbolt. This occurs by the releasing of the electric strike lip (sometimes called keeper or gate). When the door closes the beveled latchbolt rides over the lip and falls into the electric strike pocket.

FEATURES

- UL LISTED
- Non-handed
- Furnished 24VDC standard with 12VDC and AC operation optional. 16V solenoids available.
- Furnished fail secure (FSE) standard, with fail safe (FS) optional.
- Strike box is adjustable to compensate for any misalignment of the door or frame.
- Two piece plug connectors are furnished for ease of installation and for removal during strike servicing.
- Heavy-duty stainless steel construction.
- Tested to over 250,000 cycles.
- 1500 lbs. holding strength.
- 70 lbs. impact strength.

- VD-6111-FSE-630-24VDC RIM ELECTRIC STRIKE 24VDC FAIL SECURE
- VD-6112-FSE-630-24VDC RIM STRIKE SINGLE DOOR APPLICATION
- VD-6211-FSE-630-24VDC FOR MORTISE LOCK NO DEADBOLT
- VD-6216-FSE-630-24VDC FOR MORTISE LOCKS WITH DEADBOLT
- VD-050237-00 12VDC SOLENOID KIT ONLY



Known as "the can with a thousand uses," WD-40 protects metal from rust and corrosion, penetrates stuck parts, displaces moisture, and lubricates just about anything. WD-40 is also great when it comes to cleaning grease, grime, and other marks from most surfaces.

WD-40-5.5 OZ

WD-40-11 OZ



CLEANS:

WD-40 gets under dirt, grime and grease to clean. It also dissolves adhesives, allowing easy removal of labels, tape, stickers, and excess bonding material.

DISPLACES MOISTURE:

Because WD-40 displaces moisture, it quickly dries out electrical systems to eliminate moisture-induced short circuits.

PENETRATES:

WD-40 loosens rust-to-metal bonds and frees stuck, frozen or rusted metal parts.

LUBRICATES:

WD-40's lubricating ingredients are widely dispersed and hold firmly to all moving parts.

PROTECTS:

WD-40 protects metal surfaces with corrosion-resistant ingredients to shield against moisture and other corrosive elements.

FASHION



AUGUSTA



HERITAGE



The Welcome Home Series™

of Fashion Doorware™ was designed to make your life more comfortable and carefree. From classic to contemporary, ornate to refined, the Welcome Home Series offers a wide selection of styles to create that custom look. Fashion Doorware™ from Weiser Lock can make your life easier, stylish and more secure. Welcome Home!

WE-A4471-1FSN/H-3
 WE-A9471-1AUG/H-15
 WE-A9471-1AUG/H-3
 WE-A9471-1HER/H-3
 WE-A9471-1HER/H-5

FASHION (BRILLIANCE)
 AUGUSTA (SATIN NICKEL)
 AUGUSTA (BRILLIANCE)
 HERITAGE (BRILLIANCE)
 HERITAGE (ANTIQUÉ BRASS)

Complete door knob/rosette assemblies are provided for both sides of the door. The traditional style of the knobset is undeniably reliable in form and function. A polished brass or satin chrome finishes let you express your personal taste and tailor your hardware to accommodate your home decor.

BEVERLY

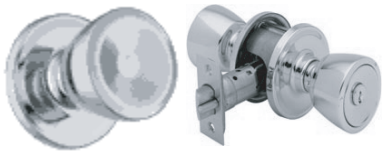

BEVERLY

WE-A101-B-26D
 WE-A101-B-3
 WE-A101-B-9/26D
 WE-A301-B-3
 WE-A301-B-9/26D
 WE-A4502B-9/26D
 WE-A501-B-9/26D
 WE-A531-B-26D
 WE-A531-B-3
 WE-A531-B-9/26D
 WE-A581-B-26D
 WE-A581-B-9/26D

PASSAGE SET, SATIN CHROME
 PASSAGE SET, BRIGHT BRASS
 PASSAGE SET, SPLIT FINISH
 PRIVACY SET, BRIGHT BRASS
 PRIVACY SET, SPLIT FINISH
 ENTRANCE LOCKSET, SPLIT FINISH
 ENTRANCE LOCKSET, SPLIT FINISH
 ENTRANCE LOCKSET, SATIN CHROME
 ENTRANCE LOCKSET, BRIGHT BRASS
 ENTRANCE LOCKSET, SPLIT FINISH
 STOREROOM LOCKSET, SATIN CHROME
 STOREROOM LOCKSET, SPLIT FINISH

FAIRFAX



FAIRFAX

WE-A101-F-26D
 WE-A101-F-3
 WE-A101-F-5
 WE-A301-F-3
 WE-A501-F-5
 WE-A531-F-26D
 WE-A531-F-3

PASSAGE SET, SATIN CHROME
 PASSAGE SET, BRIGHT BRASS
 PASSAGE LOCKSET, ANTIQUÉ BRASS
 PRIVACY LOCKSET, BRIGHT BRASS
 ENTRANCE LOCKSET, ANTIQUÉ BRASS
 ENTRANCE LOCKSET, SATIN CHROME
 ENTRANCE LOCKSET, BRIGHT BRASS

HUNTINGTON







HUNTINGTON

WE-A101-H-3-BR
 WE-A101-H-5
 WE-A101-H-15
 WE-A301-H-3
 WE-A501-H-3-BR

PASSAGE SET, BRILLIANCE BRIGHT BRASS
 PASSAGE SET, ANTIQUÉ BRASS
 PASSAGE LOCKSET, SATIN NICKEL
 PRIVACY SET, BRIGHT BRASS
 ENTRANCE LOCKSET, BRILLIANCE BRIGHT BRASS

Weiser Leversets includes 2 door levers, latch, strike, easy installation instructions, all related hardware and full manufacturer's warranty. A polished brass or satin chrome finishes let you express your personal taste and tailor your hardware to accomodate your home decor.





		KIM LEVER DESIGN	
GALIANO	KIM	WE-WLA101-K-26D	PASSAGE SET, SATIN CHROME
		WE-WLA101-K-3-FD-TMRD	PASSAGE LEVER LOCK - FIRE RATED
		WE-WLA101-K-3	PASSAGE SET, BRIGHT BRASS
		WE-WLA331-K-3	PRIVACY SET, BRIGHT BRASS
		GALIANO LEVER DESIGN	
		WE-WLA101-G-3-GALIANO	PASSAGE SET , BRIGHT BRASS
		WE-WLA331-G-3-GALIANO	PRIVACY SET, BRIGHT BRASS

DEADBOLTS

Single cylinder deadbolt locks are typically used on a front or back exterior door and are operated with a key from the exterior of the home and a thumb turn from the interior.

Double cylinder deadbolt door locks are typically used on a front or back exterior door and are operated with a key from both the exterior and interior of the home.

Double cylinder deadbolts are recommended when a window is in close proximity to the door. The interior keyway prevents an intruder from accessing your home by breaking the glass and turning the thumb turn to open the door.

		HEAVY DUTY	
		WE-D4471-3	SINGLE CYLINDER DEADLOCK (BRILLIANCE)
		WE-D4471X-26D	SINGLE CYLINDER DEADLOCK (BRILLIANCE)
		WE-D4371-26D	DOUBLE CYLINDER DEADLOCK
		WE-D4371-3	DOUBLE CYLINDER DEADLOCK
		WE-D4371-10	DOUBLE CYLINDER DEADLOCK
		STANDARD DUTY	
		WE-D9471X-15	SINGLE CYLINDER DEADBOLT, SATIN NICKEL
		WE-D9471X-26D	SINGLE CYLINDER DEADLOCK, BRILLIANCE BRASS
		WE-D9471X-3	SINGLE CYLINDER DEADBOLT, POLIHED BRASS
		WE-D9471X-5	SINGLE CYLINDER DEADBOLT, ANTIQUE BRASS
		WE-D9371X-26D	DOUBLE CYLINDER DEADLOCK, SATIN CHROME
		WE-D9371X-3	DOUBLE CYLINDER DEADLOCK, BRILLIANCE BRASS



POWERBOLT

The versatile Powerbolt 1000 touchpad deadbolt provides fast, keyless entry to your home. Installation is simple, the deadbolt easily replaces existing hardware and fits standard preparation on new doors. There is no necessary wiring, simply create a 4-8 digit code for quick, convenient, keyless access. The Powerbolt is also stylish and durable; it comes with the Weiser Brilliance® lifetime anti-tarnish finish. Uses (4) AA Alkaline Batteries.

WE-WED1460X-11P	POWERBOLT, OIL RUBBED BRONZE
WE-WED1460X-15	POWERBOLT, SATIN NICKEL
WE-WED1460X-3	POWERBOLT, POLISHED BRASS
WE-W17733-1BP	KEYPAD ONLY FOR WED1460X POWERBOLT

PARTS, PINS AND KEYBLANKS

WE-A50469-4-DEADPIN	DRIVE-IN DEADLATCH WITH DEADPIN (2-3/8 - 2-3/4)
WE-A50469-4	DRIVE-IN LATCH (2-3/8 - 2-3/4 BACKSET)
WE-A52450-4-DEADPIN	5" DEADLATCH WITH DEADPIN
WE-A52450-4	5" SPRING LATCH FOR A101/A301
WE-A52460-4-DEADPIN	DEADLATCH WITH DEADPIN (2-3/4 - 2-3/8 BACKSET)
WE-A52460-4	LATCH ONLY (2-3/8 - 2-3/4 BACKSET)
WE-A6459-1	ACTUATOR FOR MODERN, HERITAGE, FASHION (OLD STYLE)
WE-05602-HS-MECH	NEW STYLE ACTUATOR - AUGUSTA (HUN/TROY KNOB)
WE-1029	CYLINDER CAP REMOVAL TOOL
WE-1421	FOLLOWING TOOL
WE-1425	SHIM PICK
WE-985-3	MORTISE CYLINDER (1-1/8 - POLISHED BRASS)
WE-A4523-9	CYLINDER ASSEMBLY
WE-A74450-26D	BOLT ONLY FOR D9471X (5 INCH BACKSET)
WE-A74460	ADJUSTABLE BOLT ONLY FOR D9000-D4000
WE-A76469	DRIVE-IN BOLT ONLY FOR D4471/D9471 LOCK
WE-L1-A5928-6PIN-26D	6 PIN CYLINDER FOR D9471 DEADBOLT (CHROME)
WE-L1-A5928-6PIN-3	6 PIN CYLINDER FOR D9471 DEADBOLT (BRASS)
WE-W17733-1BP	KEYPAD ONLY FOR WED1460X POWERBOLT
WE-WED1460X-3	POWERBOLT C/W INSIDE PUSHBUTTON OPEN/CLOSE

WE-8552	TOP PIN (LAB-.186)		
WE-8553-0	LAB BOTTOM PIN (0-.168)	WE-8553-9	LAB BOTTOM PIN (9-.330)
WE-8553-1	LAB BOTTOM PIN (1-.186)	WE-8580-2	LAB MASTER PIN (2-.036)
WE-8553-2	LAB BOTTOM PIN (2-.204)	WE-8580-3	LAB MASTER PIN (3-.054)
WE-8553-3	LAB BOTTOM PIN (3-.222)	WE-8580-4	LAB MASTER PIN (4-.072)
WE-8553-4	LAB BOTTOM PIN (4-.240)	WE-8580-5	LAB MASTER PIN (5-.090)
WE-8553-5	LAB BOTTOM PIN (5-.258)	WE-8580-6	LAB MASTER PIN (6-.108)
WE-8553-6	LAB BOTTOM PIN (6-.276)	WE-8580-7	LAB MASTER PIN (7-.126)
WE-8553-7	LAB BOTTOM PIN (7-.294)	WE-8580-8	LAB MASTER PIN (8-.144)
WE-8553-8	LAB BOTTOM PIN (8-.312)	WE-8580-9	LAB MASTER PIN (9-.162)



WE-1555-B WEISER KEYBLANKS
SOLD IN MULTIPLES OF 50, BRASS

MORTISE CYLINDERS
SATIN CHROME FINISH
AND COMES WITH 2 KEYS

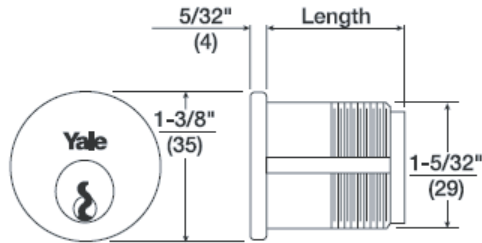

YA-1152-118-26D-GA 1-1/8", GA KEYWAY
YA-1152-118-26D-GB 1-1/8", GB KEYWAY

RIM CYLINDERS
SATIN CHROME FINISH
AND COMES WITH 2 KEYS

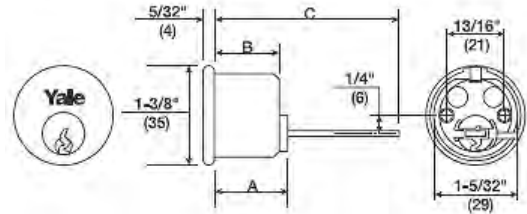

YA-1109-26D-GA GA KEYWAY, SATIN CHROME
YA-1109-26D-GB GB KEYWAY, SATIN CHROME

I/C CORE CYLINDERS
SATIN CHROME FINISH
AND COMES CONTROL KEY



YA-1210-26D-GA-O-BITT

DEADLOCKS

FOR DOORS 1-1/8" TO 2-1/4" THICK
AND A 2-3/8" BACKSET

SINGLE CYLINDER

DOUBLE CYLINDER



YA-112 DEADLOCK SINGLE CYLINDER
YA-112-1/4 DEADLOCK DOUBLE CYLINDER

JIMMY PROOF DEADLOCKS

ANTIQUE BRASS SPRAYED FINISH
DOOR THICKNESS 1-1/4" to 2-1/4"
HIGH DENSITY RUST-RESISTANT ZINC ALLOY



YA-197 JIMMY PROOF SINGLE CYLINDER
YA-197-1/4 JIMMY PROOF DOUBLE CYLINDER

RIXSON
CENTRE HUNG PIVOTS
SATIN CHROME FINISH



YA-218-689 CENTRE HUNG BOTTOM
PIVOT(OLD# 217)
YA-340-26D CENTRE HUNG TOP PIVOT

NIGHT LATCH

LATCH RETRACTED BY KEY OUTSIDE,
THUMBTURN INSIDE.

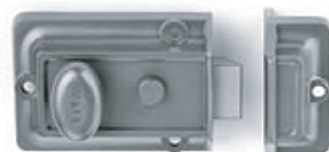

YA-80 DEADLOCK SINGLE CYLINDER